



# PA41

## REAR MOUNTED BOOM MOWER

Published 04/12

Part No. 41486.50

# OPERATOR'S MANUAL



This Operator's Manual is an integral part of the safe operation of this machine and must be maintained with the unit at all times. READ, UNDERSTAND, and FOLLOW the Safety and Operation Instructions contained in this manual before operating the equipment. *C01-Cover*



**ALAMO INDUSTRIAL®**

1502 E. Walnut  
Seguin, TX 78155  
830-372-3551

Email: [parts@alamo-industrial.com](mailto:parts@alamo-industrial.com)



## To the Owner/Operator/Dealer

This Operator's Manual is an integral part of the safe operation of this machine and must be maintained with the implement at all times. A Manual canister is provided on the implement where this manual can be properly stored. If you lose or damage this manual a free replacement manual can be obtained from an authorized Alamo Industrial dealer or by down loading the manual from the Alamo Industrial website [www.alamo-industrial.com](http://www.alamo-industrial.com)

**BEFORE YOU START! READ, UNDERSTAND, and FOLLOW** the information provided in this manual, the AEM Mower Safety manual and the tractor operator's manual carefully to learn how to operate and service your machine properly. Failure to do so could result in personal injury to you and bystanders. All implements with moving parts are potentially hazardous. Every effort has been made to ensure that this machine is safe, but operators must avoid engaging in unsafe practices and follow the written instructions provided. The manufacturer has designed this implement to be used with all its safety equipment properly attached to minimize the chance of accidents.

**SAFETY FIRST.** Completely read and understand the safety section of this manual before operating this equipment. Do not allow anyone to operate this equipment who has not fully read and understood this manual. Contact your Dealer to explain any instructions that you do not fully understand.

The care you give your Alamo Industrial Implement will greatly determine your satisfaction with its performance and its service life. Carefully read and follow the instructions in this manual to provide you with a thorough understanding of your new implement and its intended use and service requirements.

All references made in this manual to right, left, front, rear, top or bottom are as viewed facing the direction of forward travel with the implement properly attached to the tractor.

Replacement Parts information is located in a separate Parts Manual. Alamo Industrial mowers use balanced and matched system components for blade carriers, blades, cuttershafts, knives, knife hangers, rollers, drivetrain components, and bearings. These parts are made and tested to Alamo Industrial specifications. Non-genuine "will fit" parts do not consistently meet these specifications. The use of "will fit" parts may reduce mower performance, void warranties, and present a safety hazard. Use genuine Alamo Industrial mower parts for economy and safety.

For future reference, record your Alamo Industrial product model number and serial number.

Dealer		Telephone		Model Number	
Owner		Purchase Date		Serial Number	



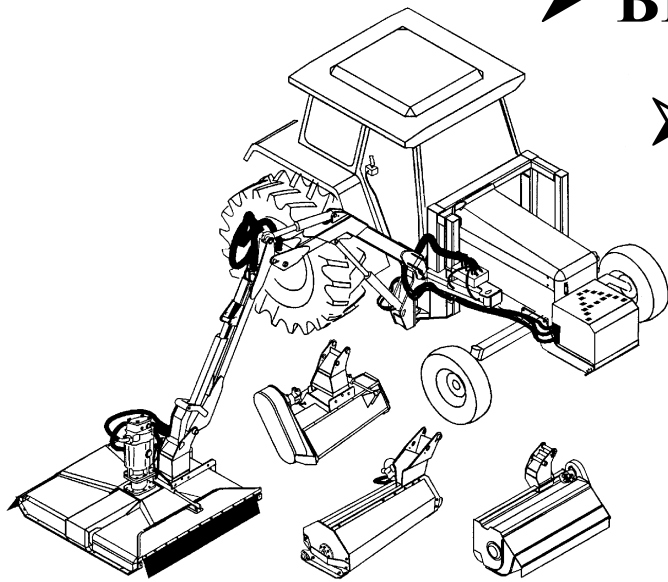

➤ **BE SAFE!**

➤ **BE ALERT!**

➤ **BE ALIVE!**

➤ **BE TRAINED**  
**before operating**  
**the Mower!**

**ALAMO**  
INDUSTRIAL

*Safety Training  
Makes the Difference*

In order to reduce accidents and enhance the safe operation of mowers, *Alamo Industrial*, in cooperation with other industry manufacturers has developed the AEM/FEMA Industrial and Agricultural Mower Safety Practices video and guide book.

The video will familiarize and instruct mower-tractor operators in safe practices when using industrial and agricultural mowing equipment. It is important that Every Mower Operator be educated in the operation of their mowing equipment and be able to recognize the potential hazards that can occur while operating a mower. This video, along with the mower operator's manual and the warning messages on the mower, will significantly assist in this important education.

Your Authorized *Alamo Industrial* Dealer may have shown this video and presented you a DVD Video when you purchased your mower. If you or any mower operator have not seen this video, **Watch the Video, Read this Operator's Manual, and Complete the Video Guidebook** before operating your new mower. If you do not understand any of the instructions included in the video or operator's manual or if you have any questions concerning safety of operation, contact your supervisor, dealer or *Alamo Group Ag*.

If you would like a VHS video tape of the video, please email [AEMVideo@alamo-group.com](mailto:AEMVideo@alamo-group.com) or Fax AEM VHS Video at (830) 372-9529 or mail in a completed copy of the form on the back of this page to AEM VHS Video 1502 E Walnut Street, Seguin, TX 78155. and request the VHS video version. Please include your name, mailing address, mower model and serial number.

Every operator should be trained for each piece of equipment (Tractor and Mower), understand the intended use and the potential hazards before operating the equipment.

The information and material listed above along with this Operator's Manual can assist you in meeting the OSHA requirement for Operator annual training.

#### **OSHA TRAINING REQUIREMENTS**

**The following training requirements have been taken from Title 29, Code of Federal Regulations Part 1928.57 (a)(6). [www.osha.gov](http://www.osha.gov)**

Operator Instructions. At the time of initial assignment and at least annually thereafter, the employer shall instruct every employee who operates an agricultural tractor or implement in the safe operating practices and servicing of equipment with which they are or will be involved, and of any other practices dictated by the work environment.

**Alamo Industrial is willing to provide  
one (1) AEM Mower Safety Practices Video**

- Please Send Me:  VHS Format – AEM/FEMA Mower Operator Safety Video  
 DVD Format – AEM/FEMA Mower Operator Safety Video  
 Mower Operator’s Manual  
 AEM Mower Operator’s Safety Manual

Requester Name: \_\_\_\_\_ Phone: \_\_\_\_\_

Requester Address: \_\_\_\_\_

City: \_\_\_\_\_

State: \_\_\_\_\_

Zip Code: \_\_\_\_\_

Mower Model: \_\_\_\_\_ Serial Number: \_\_\_\_\_

Date Purchased: \_\_\_\_\_ Dealer Salesperson: \_\_\_\_\_

Dealership Name: \_\_\_\_\_ Dealership Location: \_\_\_\_\_

Mail to:

AEM Video Services  
1502 E. Walnut Street  
Seguin, TX 78155

Or Fax to:

(830) 372-9529

Or Email to:

AEMVideo@alamo-group.com

# DEALER to CUSTOMER Pre-Delivery / Operation Instructions

Dealer should inform the Purchaser of this product of Warranty terms, provisions, and procedures that are applicable. Dealer should also inform the Purchaser to review the contents of the Operator's Manual including safety equipment, safe operation and maintenance, to review the Safety Signs on the implement (and tractor if possible) and of Purchaser's responsibility to train his/her operators in safe operation procedures.

- **IMPLEMENTS:** I have explained that Deflectors, Chain Guards, or Solid Skirts must be installed and maintained in good repair.
- **DRIVELINES:** I have made certain that all driveline, gearbox, and other shields are in good repair and fastened securely in place to prevent injuries from entanglement or thrown objects.
- **HYDRAULIC MACHINES:** I have explained the necessity of using clean hydraulic oil, changing filters as instructed, stopping leaks, damage caused by operating with over-heated oil, caring for hoses, using hoses of proper rating, maintaining the specified operating pressure and the potential hazard of oil's penetrating the skin.
- **FOLDING-TYPE IMPLEMENTS:** I have explained that it is not possible to guard against thrown objects when the head is lifted off ground and that operator is responsible to watch out for persons in the area. I have explained that the lifted mower head or boom can contact overhead obstructions with damage to cables and telephone lines and possible injury. I have explained that the extended head or boom or retracted boom can contact power lines with resulting electrocution, injury or death and that operator is responsible for keeping clear of such hazards.

## PRE-DELIVERY SERVICE CHECK AND ADJUST OR LUBRICATE AS REQUIRED

See Operator's Manual for Details

### Inspection Performed - Warranty and Safety Procedures Explained - Installation Complete

#### LUBRICATION & HYDRAULICS

- Gearbox (Oil Levels)
- Hydraulic Oil Level (External Tank)
- Tractor Hydraulic Oil Level
- Hydraulic Hoses (Not Kinked Tighten Connections)
- Front Pump Drive (Assembly Is Tight And Shaft Properly Aligned)

#### MOWER

- Spindle And Motor Bolts Properly Torqued
- Spindle Oil Level
- Blade Carrier Bolts Properly Torqued/Retaining Pin In Place
- Mower Cutting Height And Level Adjusted
- Cutting Shaft Bearings Lubricated
- All Hardware Properly Torqued
- Tire and Air Pressure/Lug Nuts (Correct Torque)
- Wheel Bearings (Check, Grease, and Preload)

#### ATTACHMENTS & INSTALLATION

- Deflectors Front And Rear
- Shredding Attachments
- Correct Blade Rotation Direction
- Axle Arms And Beams
- Tongue And Control Rods (Installed And Adjusted)
- All Bolts - Pins And Nuts (Proper Torque)

#### MOWER TO TRACTOR CONNECTIONS

- Draw Bar Length (Check And Set)
- A-Frame Pivot & Links
- Control Rods (Adjusted Equal)
- Axle Height (Adjusted)
- Cutting Height (Adjust)
- Mount Kit-Pre-Operation Check Complete
- Mower Wing (Adjust Level With The Center)
- Mower Wing (Check For Proper Raising Operation)
- C.V. Drivelines (Check Max Turn Radius)
- Pull Type Hitch (Height Adjustment)
- Mounting Hardware Properly Torqued

#### SAFETY ITEMS

- Protective Shields (Operation And Installation)
- Driveline Clutch (Torque Limiter) (Adjust And Run In)
- Safety Decals (Installed)
- Operator's Manual (Supplied)
- Tractor PTO Shield (Installed)
- S.M.V. Emblem (Installed If Needed)
- Tongue Jack (Installation and Operation)
- Safety Tow Chain (Installed)
- ADMA Driveline Safety Manual Supplied
- AEM Mower Safety Manual (Supplied in Canister)
- AEM Mower Safety Video has been shown to Purchaser



# TABLE OF CONTENTS

<b>SAFETY SECTION .....</b>	<b>1-1</b>
GENERAL SAFETY INSTRUCTIONS AND PRACTICES .....	1-2
Operator Safety .....	1-3
CRUSHING HAZARDS .....	1-4
CONNECTING OR DISCONNECTING IMPLEMENT SAFETY .....	1-5
THROWN OBJECTS HAZARDS .....	1-6
RUN OVER HAZARDS .....	1-8
PTO ENTANGLEMENT HAZARDS .....	1-9
MOWER BLADE CONTACT HAZARDS .....	1-10
HIGH PRESSURE OIL LEAK HAZARD .....	1-11
ELECTRICAL & FIRE HAZARDS .....	1-12
TRANSPORTING HAZARDS .....	1-13
HAZARDS WITH MAINTENANCE OF IMPLEMENT .....	1-14
PARTS INFORMATION .....	1-15
Decal Location .....	1-15
Decal Description .....	1-19
Federal Laws and Regulations .....	1-30
<b>INTRODUCTION SECTION .....</b>	<b>2-1</b>
<b>ASSEMBLY SECTION .....</b>	<b>3-1</b>
TRACTOR SELECTION .....	3-2
TRACTOR PREPARATION .....	3-3
Fitting Operator Guard .....	3-3
Wheel Width .....	3-4
Ballast Weight .....	3-4
Front Weights .....	3-4
CLOSED CENTER CONVERSION KIT (81- 30- 059) for Si Models .....	3-4
DELIVERY .....	3-5
ATTACHMENT TO TRACTOR .....	3-5
FITTING CONTROL UNIT IN CAB .....	3-11
OIL REQUIREMENTS .....	3-12
Tank .....	3-12
Gearbox .....	3-12
RUNNING UP PROCEDURE .....	3-13
Ti Models Only - With Flail Head Only .....	3-13
Si Models Only - With Cutterbar or Flail Head .....	3-13
All models .....	3-13
REMOVAL FROM TRACTOR .....	3-13
<b>OPERATION SECTION .....</b>	<b>4-1</b>
OPERATOR REQUIREMENTS .....	4-3
Standard Equipment and Specifications .....	4-4
TRACTOR REQUIREMENTS .....	4-5
ROPS and Seat Belt .....	4-5
Operator Thrown Object Protection .....	4-5
Tractor Lighting and SMV Emblem .....	4-6
Tractor Ballast .....	4-6
Tractor Safety Devices .....	4-7
Tractor Horsepower .....	4-7

3-Point Hitch .....	4-7
Hydraulics .....	4-7
Front End Weight .....	4-7
Power Take Off (PTO) .....	4-8
GETTING ON AND OFF THE TRACTOR .....	4-8
Boarding the Tractor .....	4-9
Dismounting the Tractor .....	4-9
STARTING THE TRACTOR .....	4-10
PRE-OPERATION INSPECTION AND SERVICE .....	4-11
Tractor Pre-Operation Inspection/Service .....	4-11
Boom Unit Pre-Operation Inspection and Service .....	4-12
MACHINE CONTROLS .....	4-19
Cable Controls - Identification & Function .....	4-19
Lever Functions .....	4-20
Rotor Control - Ti Machines only .....	4-21
ENGAGING DRIVE .....	4-22
OPERATING SPEED .....	4-22
FORWARD SPEED .....	4-23
PARALLEL MOTION GEOMETRY .....	4-23
BREAKAWAY .....	4-23
ANGLE FLOAT .....	4-24
High Voltage Cables .....	4-24
Hedge Cutting Procedure .....	4-25
Working on Adverse Slopes .....	4-26
Lift Float Kit (Optional) .....	4-27
DRIVING THE TRACTOR AND IMPLEMENT .....	4-27
Starting the Tractor .....	4-28
Brake and Differential Lock Setting .....	4-29
Driving the Tractor and Boom .....	4-30
OPERATING THE TRACTOR AND IMPLEMENT .....	4-31
Foreign Debris Hazards .....	4-31
Bystanders/Passersby Precautions .....	4-32
Engaging the Power Take Off (PTO) .....	4-32
Operating Speed and Ground Speed .....	4-33
Operating the Mower .....	4-33
Operating the Attached Mower Heads .....	4-34
Shutting Down the Attached Head .....	4-36
TRACTOR, BOOM, AND ATTACHED HEAD STORAGE .....	4-37
TRANSPORTING THE TRACTOR AND IMPLEMENT .....	4-37
Transport Position .....	4-38
TRANSPORT POSITION - Head Attached .....	4-38
TRANSPORT POSITION - Head Removal .....	4-39
Transport Height .....	4-39
Transporting on Public Roadways .....	4-40
Hauling the Tractor and Implement .....	4-42

**MAINTENANCE SECTION ..... 5-1**

HAZARDS WITH MAINTENANCE OF IMPLEMENT .....	5-2
LUBRICATION INFORMATION .....	5-3
PTO SHAFT LUBRICATION .....	5-4
PTO SHAFT INSPECTION .....	5-4
PTO GEARBOX .....	5-4
Oil Supply .....	5-5
Filtration Maintenance .....	5-5
Hose Replacement .....	5-6



Hose Warranty .....	5-6
CYLINDER ROD MAINTENANCE .....	5-7
PROPER TORQUE FOR FASTENERS .....	5-9
Flail Blades Inspection .....	5-12
Blade Pins and D-Ring Inspection .....	5-13



# **SAFETY SECTION**

Safety Section 1-1

# SAFETY

## GENERAL SAFETY INSTRUCTIONS AND PRACTICES

A careful operator is the best operator. Safety is of primary importance to the manufacturer and should be to the owner/operator. Most accidents can be avoided by being aware of your equipment, your surroundings, and observing certain precautions. The first section of this manual includes a list of Safety Messages that, if followed, will help protect the operator and bystanders from injury or death. Read and understand these Safety Messages before assembling, operating or servicing this Implement. This equipment should only be operated by those persons who have read the manual, who are responsible and trained, and who know how to do so responsibly.



The Safety Alert Symbol combined with a Signal Word, as seen below, is used throughout this manual and on decals which are attached to the equipment. The Safety Alert Symbol means: "ATTENTION! BECOME ALERT! YOUR SAFETY IS INVOLVED!" The Symbol and Signal Word are intended to warn the owner/operator of impending hazards and the degree of possible injury faced when operating this equipment.

**Practice all usual and customary safe working precautions and above all--- remember safety is up to YOU. Only YOU can prevent serious injury or death from unsafe practices.**



Indicates an imminently hazardous situation that, if not avoided, WILL result in DEATH OR VERY SERIOUS INJURY.



Indicates an imminently hazardous situation that, if not avoided, COULD result in DEATH OR SERIOUS INJURY.



Indicates an imminently hazardous situation that, if not avoided, MAY result in MINOR INJURY.



Identifies special instructions or procedures that, if not strictly observed, could result in damage to, or destruction of the machine, attachments or the environment.

**NOTE:** *Identifies points of particular interest for more efficient and convenient operation or repair.*

READ, UNDERSTAND, and FOLLOW the following Safety Messages. Serious injury or death may occur unless care is taken to follow the warnings and instructions stated in this Manual and in the Safety Messages on the implement. Always follow the instruction in this manual and use good common sense to avoid hazards.



**NOTE:** *If you want a translation of this safety section in one of the following Languages, please contact: Translations at 1502 E. Walnut Street Seguin, TX 78155; Fax: (830) 372-9529; Safety Section Translations are available in Spanish, Portuguese, French, German, Russian. PN GS01*

# SAFETY

## Operator Safety

				
Read and understand Operator's Manual	Always wear Safety Glasses	Wear Hard Hat Safety Shoes	Never use Drugs or Alcohol when operating equipment	Wear Safety Vest when operating on or near roads

### **WARNING**

TO AVOID SERIOUS INJURY OR DEATH DO THE FOLLOWING:

- **READ, UNDERSTAND** and **FOLLOW** Operator's Manual instructions, Warnings and Safety Messages.
- **WEAR SAFETY GLASSES**, safety shoes, hard hat, hearing protection and gloves when operating or repairing equipment
- **WEAR** appropriate breathing respirator when operating in dusty conditions to avoid respiratory diseases.
- **DO NOT WEAR** loose clothing or jewelry to avoid rotating parts entanglement injury.
- **DO NOT USE DRUGS** or **ALCOHOL** before or while operating equipment.
- **DO NOT ALLOW** anyone to operate equipment under the influence of drug or alcohol.
- **CONSULT** medical professional for medication impairment side effects.
- **STAY CLEAR** of hot surfaces such as Mufflers, hydraulic pumps, valves and tanks.
- **STAY ALERT**, prolonged operation can cause fatigue, **STOP** and **REST**.

### **GENERAL OPERATING SAFETY**

#### **VISIBILITY CONDITIONS WHEN MOWING:**

- **OPERATE IN DAYLIGHT** or with lights that gives at least 100 yards clear visibility.
- **BE ABLE TO SEE** and identify passersby, steep slopes, ditches, drop-offs, overhead obstructions, power lines, debris and foreign objects.
- Avoid backing up while mowing, vision may be limited, severe damage or injury can occur.
- **DO NOT** run tractor in enclosed building without adequate exhaust ventilation.

#### **GROUND SPEED WHEN MOWING:**

- **NORMAL SPEED** range is between 1 to 2 mph(1-3 kph).
- **ADJUST MOWING SPEED** for terrain conditions and grass type, density and cut height.
- **REDUCE MOWING SPEED** when near steep slopes, ditches, drop-offs, overhead obstructions, power lines and to avoid debris and foreign objects.

#### **TRACTOR and MOWER**

- **DO NOT** operate the tractor or mower unless the equipment is maintained and operating properly.
- **DISCONTINUE OPERATION** if tractor or mower electrical and hydraulic controls do no function properly.
- **DISCONTINUE OPERATION** of the tractor if the braking or steering systems do not function properly.
- **DO NOT** operate the tractor or mower if there are any hydraulic leaks.

#### **INSECT INFESTATION**

- **DO NOT** operate in areas where bees or insects may attack unless you **WEAR PROTECTIVE CLOTHING** or use enclosed tractor cab.

#### **PTO SPEED:**



- **DO NOT EXCEED IMPLEMENT RATED PTO SPEED**
- **AVOID** exceeding rated PTO speeds that may result in broken drivelines or blade failures.

#### **SAFETY SIGNS:**

- **REPLACE** missing, damaged or unreadable safety signs immediately. *PN OSBM-01*

# SAFETY

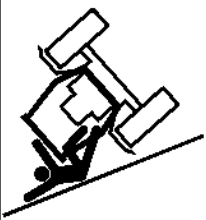
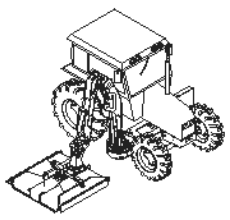
## CRUSHING HAZARDS

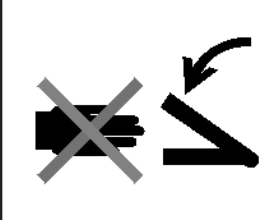
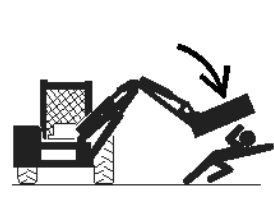
				
Crushing injury from roll over	Use Cab Tractor With Boom Mowers	Always wear seatbelt	Pinch Point Hazard Keep Hands and body parts clear of pinch points	Crushing injury from boom or mower head falling

**⚠ DANGER**

TO AVOID SERIOUS INJURY OR DEATH FROM FALLING OFF TRACTOR, EQUIPMENT RUN OVER, ROLLOVER AND CRUSHING BY FALLING WING OR IMPLEMENT:

- USE ROPS and SEAT BELT equipped tractors for mowing operations.
- KEEP ROPS lock in up position.
- ALWAYS BUCKLE UP seat belt when operating tractor and equipment.
- ONLY OPERATE tractor and equipment while seated in tractor seat.

**WHEN RAISING BOOM MOWER:**

- Raise or lower **ONLY WHILE SEATED** in tractor seat with seat belt buckled.
- KEEP BYSTANDERS CLEAR of area **TO AVOID** crushing.
- KEEP sufficient clearance around implement and wings **TO AVOID** contacting buildings or overhead power lines.

**LIFTED Equipment can fall from mechanical or hydraulic failure or inadvertent Control Lever movement.**

**⚠ WARNING**

TO AVOID EQUIPMENT FALLING while working near or under lifted boom, components and Mower Head:

- SECURELY SUPPORT or block up raised equipment, wings and components.
- BLOCK UP and securely support equipment before putting hands, feet or body under raised equipment or lifted components.
- KEEP BYSTANDERS CLEAR of raised boom or mower head until securely blocked up.

**WHEN PARKING Implement and Tractor:**

- LOWER Mower Head to the ground or **BLOCK** lifted parts before leaving equipment.
- NEVER leave implement unattended in a raised position.



**⚠ WARNING**

TO AVOID CHILDREN FALLING OFF OR BEING CRUSHED BY EQUIPMENT:

- NEVER ALLOW children to play on or around Tractor or Implement.
- DO NOT operate without operator CAB or OVERHEAD protection. Falling limbs and debris can cause injuries. *PN CHBM-01*

# SAFETY

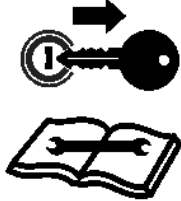
## CONNECTING OR DISCONNECTING IMPLEMENT SAFETY

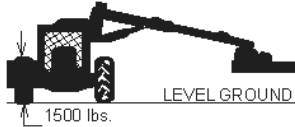
			
<p>Stop Tractor Remove Key Read Manual</p>	<p>Crushing Hazard Do Not get under boom when connecting mower head to boom</p>	<p>Stability Hazard Ensure 20% of tractor weight is on front wheels</p>	<p>Stability Hazard Ensure 1500lbs down force on left tire with boom extended</p>



**TO AVOID SERIOUS INJURY OR DEATH FROM BEING CRUSHED BY TRACTOR OR IMPLEMENT:**

**WHEN connecting mower head to the boom:**

- **KEEP BYSTANDERS AWAY** from tractor and mower.
- Ensure there is enough room to lift and swing the boom with out hitting objects

**BEFORE connecting and disconnecting the mower head or boom:**

- **STOP TRACTOR ENGINE**, place transmission into park, engage parking brake and remove key.

**WHEN connecting and disconnecting the mower head or boom:**

- **DO NOT** crawl or walk under raised mower head or boom. (*Refer to Instructions in Operation Section*)

**WHEN CONNECTING IMPLEMENT DRIVELINE:(If equipped)**

**TO AVOID implement driveline coming loose during operation:**

- **LUBRICATE** yoke spring locking collar to ensure it freely slides on PTO shaft.
- **SECURELY** seat yoke locking balls in PTO shaft groove.
- **PUSH and PULL DRIVELINE** on both the tractor and implement **PTO SHAFTS** to ensure it is **SECURELY ATTACHED**.

**TO AVOID broken driveline during operations:**





- **CHECK** driveline for proper length between PTO shaft and implement gearbox shaft. (*Refer to Instructions in Operation Section*)
- Drivelines too short can pull apart or disengage.
- Drivelines too long can bottom out.
- Bottoming driveline telescoping assembly will stop sliding and become solid.
- Driveline bottoming can push through support bearings and break off PTO shaft.

**CONTACT DEALER if implement driveline does not match Tractor PTO shaft:**

- **DO NOT USE PTO ADAPTER.**  
Using a PTO adapter can cause:
  - Excessive vibration, thrown objects, blade and implement failures by doubling operating speed.
  - Increased working length exposing unshielded driveline areas and entanglement hazards. *PN CDBM-01*

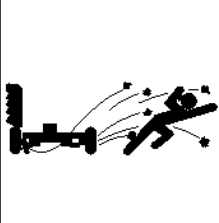
# SAFETY

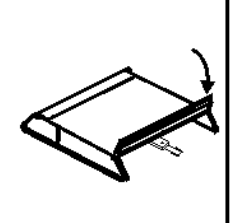
## THROWN OBJECTS HAZARDS

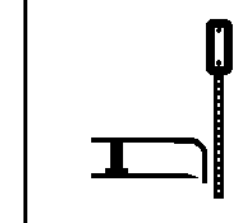
				
Mower Thrown Objects Hazard	Raised Mower Thrown Objects	Keep mower door closed when traffic comes within 300 feet	Inspect Area remove foreign objects	Do not let blades contact solid objects



**ROTARY MOWERS CAN THROW OBJECTS 300 FEET OR MORE UNDER ADVERSE CONDITIONS.**

### TO AVOID SERIOUS INJURY OR DEATH TO OPERATOR OR BYSTANDERS FROM THROWN OBJECTS:

- KEEP bystanders 300 feet away

### STOP MOWING IF PASSERSBY ARE WITHIN 300 FEET UNLESS:

- **ALL THROWN OBJECT SHIELDING** including, Front and Rear Deflectors, Chains Guards, Steel Guards, Bands, Side Skirts and Skid Shoes in place and in good condition when mowing.
- Mower is close and parallel to ground without exposing blades.
- **MOWING AREA** has been inspected and foreign materials and debris have been removed.
- **DO NOT** shred or mow loose or previously cut material if **BYSTANDERS** are within 300 feet.
- **PASSERSBY** are inside enclosed vehicle.

### INSPECT AREA FOR POTENTIAL THROWN OBJECTS BEFORE MOWING:

- **REMOVE** debris, rocks, wire, cable, metal objects and other foreign material from area.  
Wire, cable, rope, chains and metal objects can be thrown or swing outside deck with great velocity:
  1. **MARK** objects that cannot removed.
  2. **AVOID** these objects when mowing.

### HIGH GRASS and WEED AREA INSPECTION:

- **INSPECT** for and **REMOVE** any hidden large debris.
- **MOW** at Intermediate height
- **INSPECT** and remove remaining debris
- **MOW** at final height.

### MOWER THROWN OBJECT SHIELDING:

- **KEEP** all thrown object shielding including, Front and Rear Deflectors, Chains Guards, Steel Guards, Bands, Side Skirts and Skid Shoes in place and in good condition when mowing.
- **DO NOT OPERATE** with any thrown object shielding missing, damaged or removed.





### RIGHT OF WAY (Highway) MOWING

- Stop mowing if any bystander comes within 300 feet of the mower.
- No shielding is 100% effective in preventing thrown objects. To Reduce Possibility of Injury:
  1. **MAINTAIN MOWER SHIELDING**, side skirts, skid shoes, and blades in good operational condition,
  2. **RAISE CUTTING HEIGHT** to **6 INCHES** minimum,
  3. **INSPECT AREA** thoroughly before mowing to **REMOVE** potential **THROWN OBJECT HAZARDS**,
  4. **NEVER ALLOW BLADES** to **CONTACT SOLID OBJECTS** like wire, rocks, post, curbs, guardrails, or ground while mowing. *PN TOBM-01*

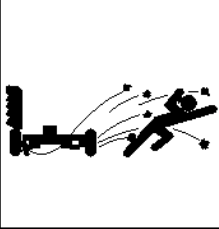

# SAFETY

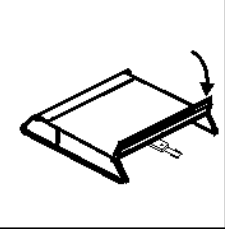
## THROWN OBJECTS HAZARDS (Continued)

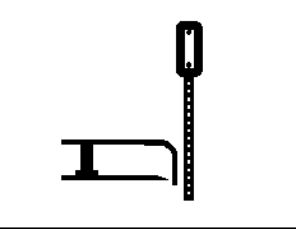
				
Mower Thrown Objects Hazard	Raised Mower Thrown Objects	Keep mower door closed when traffic comes within 300 feet	Inspect Area remove foreign objects	Do not let blades contact solid objects

### MOWER OPERATION:

- **DO NOT** exceed mower's rated Cutting Capacity or cut non-vegetative material.
- **USE ENCLOSED TRACTOR CABS** when two or more mowers are operating in mowing area.
- Do Not mow in areas where bees or insects may attack unless you **WEAR PROTECTIVE CLOTHING** or use enclosed tractor cab.
- **ADJUST** mower head close and parallel to ground without exposing blades.
- **ADJUST** cutting **HEIGHT** to **AVOID BLADE CONTACT** with solid objects like wire, rocks, posts, curbs, guard rails and fixed obstructions.
- **CLOSE** Mower door and stop operating if bystanders come within 300 feet of the mower.
- Keep mower door closed when cutting close to the ground.
- Open door only to cut large brush or tree limbs. Close door immediately after cutting limb.
- **DO NOT** push mower head down onto material to cut it, use the front tips of the mower blades to cut into the material.
- **DO NOT** operate mower when mower is in transport position.
- **STOP MOWING** immediately if blades strike heavy objects, fixed structures, metal guard rails and concrete structures:
  1. **BLADES CAN FAIL** from impact and objects can be thrown with great velocity.
  2. **INSPECT** and **REPLACE** any damaged blades.
  3. **CHECK** blade carrier and **REPLACE** if damaged.
- **DO NOT** mow in standing water **TO AVOID** possible **BLADE FAILURE**.
- **AVOID MOWING** in reverse:
  1. **STOP PTO** and back up mower.
  2. **LOWER** mower, engage **PTO** and mow forward.
- **DISENGAGE** mower head and wait until **BLADES** stop rotating before raising mower to transport position.
- **DO NOT ENGAGE PTO** with mower in transport position.
- **STOP** mowing when **EXCESSIVE VIBRATION** occurs:
  1. **STOP PTO** and tractor **ENGINE**.
  2. **INSPECT** mower for vibration source.
  3. **REPLACE** any damage parts and bent or damaged **BLADES**. *PN TOBM-02*

# SAFETY

## RUN OVER HAZARDS

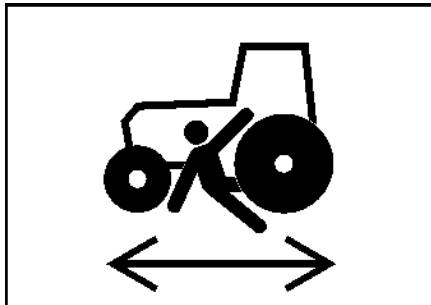

Operator run over hazard

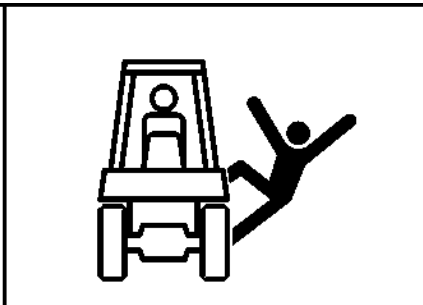

Rider fall off run over hazard

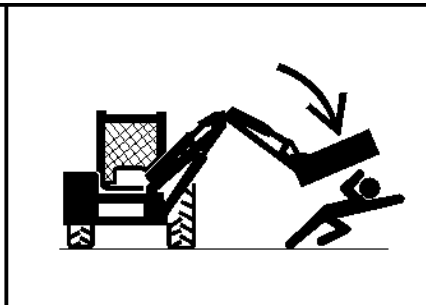

Bystander run over hazard

### **⚠ DANGER**

TO AVOID SERIOUS INJURY OR DEATH FROM FALLING OFF TRACTOR OR EQUIPMENT RUN OVER:

- **USE ROPS** and **SEAT BELT** equipped tractors for mowing operations.
- **KEEP ROPS** locked in **UP** position.
- **ONLY** start tractor while seated in tractor seat.
- **ALWAYS BUCKLE UP** seat belt when operating tractor and equipment.
- **ONLY OPERATE** tractor and equipment while seated in tractor seat.
- **NEVER ALLOW RIDERS** on tractor or implement.
- When not mowing stow Boom and Mower head in transport location before moving.



### **WHEN MOUNTING AND DISMOUNTING TRACTOR:**

- **ONLY** mount or dismount when tractor and moving parts are stopped.
- **STOP ENGINE AND PTO**, engage parking brake, lower implement, allow all moving parts to stop and remove key before dismounting from tractor. *PN ROBM-01*

# SAFETY

SAFETY

## PTO ENTANGLEMENT HAZARDS

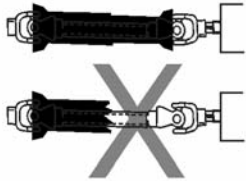
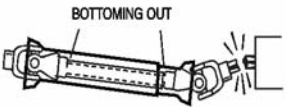
	 <p>PTO (Barra Gitatoria)</p>		
<p>Entanglement hazard Do Not approach or touch a rotating PTO driveshaft</p>	<p>Make sure PTO shaft is securely attached Do Not Use PTO Adapter</p>	<p>DO NOT Operate if PTO shields are damaged or missing</p>	<p>Make sure PTO shafts are proper length</p>



**KEEP AWAY FROM ROTATING DRIVELINES AND ELEMENTS TO AVOID SERIOUS INJURY OR DEATH:**

**STAY AWAY** and **KEEP** hands, feet and body **AWAY** from rotating blades, drivelines and parts until all moving elements have stopped.

- **STOP, LOOK** and **LISTEN** before approaching the mower to make sure all rotating motion has stopped.
- **ROTATING COMPONENTS CONTINUE** to **ROTATE** after the PTO is shut off.

### PTO SHIELDING:

#### TO AVOID SERIOUS INJURY OR DEATH FROM ENTANGLEMENT WHEN OPERATING IMPLEMENT:

- **KEEP PTO** shields, integral driveline shields and input shields installed
- **DO NOT OPERATE** mower without shields and guards in place or missing
- **REPAIR OR REPLACE** if damage, broken or missing
- **ALWAYS REPLACE GUARDS** that have been removed for service or maintenance.
- Do Not use PTO or PTO guard as a step.

#### TO AVOID broken driveline during operations:

- **CHECK** driveline for proper length between PTO shaft and implement gearbox shaft. *(Refer to Instructions in Operation Section)*
- Drivelines too short can pull apart or disengage.
- Drivelines too long can bottom out.  
Bottoming driveline telescoping assembly will stop sliding and become solid.
- Driveline bottoming can push through support bearings and break off PTO shaft
- **AVOID** sharp turns or lift mower to heights to cause driveline "knocking".
- Lubricate driveshaft-telescoping components weekly.



#### CONTACT DEALER if implement driveline does not match Tractor PTO shaft:

- **DO NOT USE PTO ADAPTER.**

Using a PTO adapter can cause excessive vibration, thrown objects, blade and implement failures by doubling operating speed. Increased working length exposing unshielded driveline areas. *PN PE01*

# SAFETY

## MOWER BLADE CONTACT HAZARDS

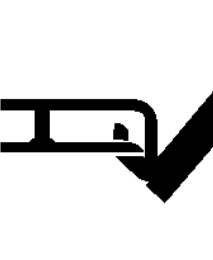
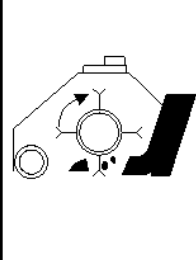
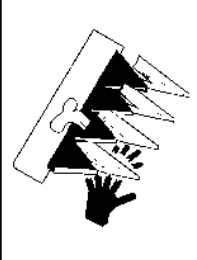
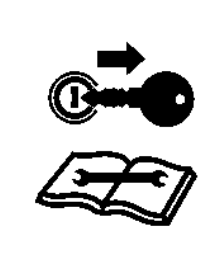
					
Do not put fingers underneath mower	Do not put hands underneath Flail Mower	Do not put foot underneath mower	Do not put foot underneath Flail Mower	Shearing Hazard from Sickle blades	Stop Tractor Remove Key Read Manual

**⚠ DANGER**





**KEEP AWAY FROM ROTATING BLADES TO AVOID SERIOUS INJURY OR DEATH FROM BLADE CONTACT:**

- **STAY AWAY** and **KEEP HANDS, FEET** and **BODY AWAY** from rotating blades, drivelines and parts until all moving elements have stopped.
- **DO NOT** put hands or feet under mower decks
- **STOP** rotating **BLADES** disengage mower switch and PTO and wait for blade to stop rotating before raising mower head.
- **DO NOT** approach Sickle Bar head until Tracto Engine has been shut off.
- **STOP LOOK** and **LISTEN** before approaching the mower to make sure all rotating motion has stopped. *PN MBBM-01*

SAFETY

# SAFETY

## HIGH PRESSURE OIL LEAK HAZARD

			
<p>High pressure oil penetrating skin</p>	<p>High pressure oil eroding skin</p>	<p>Using cardboard to check for oil leaks</p>	<p>Tank contents under pressure. Allow oil to cool before slowly removing cap</p>



**TO AVOID SERIOUS INJURY OR DEATH FROM HIGH PRESSURE HYDRAULIC OIL LEAKS PENERATING SKIN:**

- **DO NOT OPERATE** equipment with oil or fuel leaks.
- **KEEP** all hydraulic hoses, lines and connections in **GOOD CONDITION** and **TIGHT** before applying system pressure.
- **RELIEVE HYDRAULIC PRESSURE** before disconnecting lines or working on the system.
- **REMOVE** and replace hose if you suspect it leaks. Have dealer test it for leaks.

**HIGH PRESSURE FLUID LEAKS CAN BE INVISIBLE.**

**WHEN CHECKING FOR HYDRAULIC LEAKS AND WORKING AROUND HYDRAULIC SYSTEMS:**

- **ALWAYS WEAR** safety glasses and impenetrable gloves.
- **USE** paper or cardboard to search for leaks.
- **DO NOT USE** hands or body parts to search for leak.
- **KEEP** hands and body **AWAY** from pin holes and nozzles ejecting hydraulic fluid.
- Hydraulic fluid may cause gangrene if not surgically removed immediately by a doctor familiar with this form of injury.

**Use caution when removing Hydraulic Tank cap.**

- Tank contents maybe under pressure
- Allow oil to cool before removing cap.
- Relieve oil pressure before removing cap slowly.
- Stay away from hot oil that may spray from tank.

*PN HPBM-01*

# SAFETY

## ELECTRICAL & FIRE HAZARDS

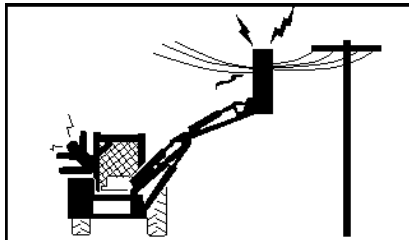

Mower head or Boom contacting overhead electrical lines



Strike and explosion Hazard  
Blades Contacting Utility or Gas Lines

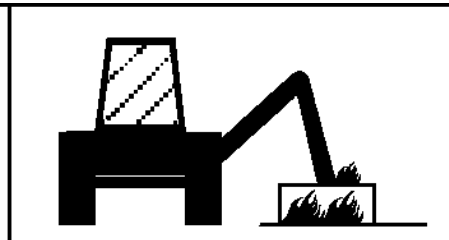

Fire Hazard Do Not operate near fires. Keep debris away from hydraulic pumps and valves

### **⚠ DANGER**

**TO AVOID SERIOUS INJURY OR DEATH FROM ELECTRICAL CONTACT WHEN WORKING AROUND ELECTRICAL POWER LINES, GAS LINES AND UTILITY LINES:**

- **INSPECT** mowing area for overhead or underground electrical power lines, obstructions, gas lines, cables and Utility, Municipal, or other type structure.
- **KEEP** all raised wings at a 10 feet or greater distance from all power lines and overhead obstructions.
- **DO NOT** allow mower to contact with any Utility, Municipal, or type of structures and obstructions.
- **CALL 811** and 1-800-258-0808 for identify buried utility lines.

**FIRE PREVENTION GUIDELINES while Operating, Servicing, and Repairing Mower and Tractor to reduce equipment and grass fire Risk:**

- **EQUIP** Tractor with a **FIRE EXTINGUISHER**
- **DO NOT OPERATE** mower on a tractor equipped with under frame exhaust
- **DO NOT SMOKE** or have open flame near Mower or Tractor
- **DO NOT DRIVE** into burning debris or freshly burnt area
- **AVOID FIRE IGNITION** by not allowing mower blade to contact solid objects like metal or rock.
- **DO NOT** operate if oil is leaking. Repair oil leak and remove all accumulated oil before operating.
- **CLEAR** any grass clippings or debris buildup around mower hydraulic pumps, valves or tanks.
- **SHUT OFF ENGINE** while refueling. *PN EFBM-01*

# SAFETY

## TRANSPORTING HAZARDS

		
<p>Use SMV signs and Flashing Lights</p>	<p>Loss of Control Stopping Hazard</p>	<p>Loss of Control Speeding Hazard</p>

**WARNING**

TO AVOID SERIOUS INJURY AND DEATH WHEN TOWING OR TRANSPORTING EQUIPMENT:

- **KEEP** transport speed **BELOW** 20 mph to maintain control of equipment.
- **REDUCE SPEED** on inclines, on turns and in poor towing conditions.
- **DO NOT TOW** with trucks or other vehicles.
- **USE** only properly sized and equipped tractor for towing equipment.
- **FOLLOW** all local traffic regulations.

**TRACTOR REQUIREMENTS FOR TOWING OR TRANSPORTING IMPLEMENTS:**

- **ONLY TRANSPORT** with tractor with **ROPS** in the raised position.
- **USE** properly sized and equipped tractor that exceeds implement weight by at least 20%.
- **KEEP** 20% of tractor weight on front wheels to maintain safe steering.

**BEFORE TRANSPORTING OR TOWING IMPLEMENT:**

**TRACTOR INSPECTION:**

- **CHECK** steering and braking for proper operation and in good condition.
- **CHECK SMV** sign, reflectors and warning lights for proper operation and visibility behind unit.
- **CHECK** that your driving vision is not impaired by tractor, cab, or implement while seated in tractor seat.
- **ADJUST** your operating position, mirrors, and implement transport for clear vision for traveling and traffic conditions.

**PREPARE IMPLEMENT FOR TRANSPORTING OR TOWING:**

- Store Boom and Mower in transport positions and engage transport locks if equipped.

**DETERMINE STOPPING CHARACTERISTICS OF TRACTOR AND IMPLEMENT FOR TRANSPORTING OR TOWING:**

**BRAKING TESTS:**

- Stopping distance with implement attached may increase
- Observe **STOPPING** distances increases with increased speeds.
- **DETERMINE** the maximum safe transport speed that does not exceed 20 mph.
- Reduce travel speed in wet or icy roads, stopping distances increase.

**DETERMINE MAXIMUM TURNING SPEED BEFORE OPERATING ON ROADS OR UNEVEN GROUND:**

- **TEST** equipment in slowly increasing speed in turns to determine it can be operated at higher speeds.
- **USE REDUCED** turning speeds in sharp turns to avoid equipment turning over.





**WHEN TOWING OR TRANSPORTING EQUIPMENT:**

- Always **WEAR SEAT BELT** when operating or transporting mower.
- **USE** low speeds to avoid overturn with raised wings.
- **USE** low speeds and gradual steering on curves, hills, rough or uneven surfaces and on wet roads.
- **TURN ON** tractor **FLASHING WARNING LIGHTS**.
- **ALLOW** clearance for implement swing while turning.

**KEEP raised boom mower 10 feet or greater distance from all power lines and overhead obstructions. PN THBM-01**

# SAFETY

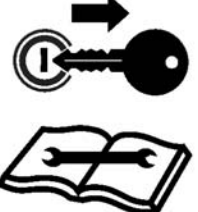
## HAZARDS WITH MAINTENANCE OF IMPLEMENT

				
Periodically inspect all moving parts, lubricate drivelines, and tighten all fasteners	Lower mower head to ground or block up before servicing	Stop engine remove key before conducting maintenance	Set mower head securely on the ground before servicing blades	Thrown Objects Hazard Ensure blades rotate clockwise viewed from above mower head

### **WARNING**

**AVOID SERIOUS INJURY OR DEATH FROM COMPONENT FAILURE BY KEEPING IMPLEMENT IN GOOD OPERATING CONDITION IN PERFORMING PROPER SERVICE, REPAIRS AND MAINTENANCE.**

#### **BEFORE PERFORMING SERVICE, REPAIRS AND MAINTENANCE ON THE IMPLEMENT:**

- **STOP ENGINE AND PTO**, engage parking brake, lower implement, allow all moving parts to stop and remove key before dismounting from tractor.
- **PLACE** implement on ground or securely block up raised equipment. Use large blocks on soft or wet soil.
- **PUSH** and **PULL** Remote Hydraulic Cylinder lever to relieve hydraulic pressure.
- **DISCONNECT Pump solenoid valve or PTO driveline connection before servicing mower head.**
- **WEAR SAFETY GLASSES, PROTECTIVE GLOVES** and follow **SAFETY PROCEDURES** when performing service, repairs and maintenance on the implement:
  - Always **WEAR** protective **GLOVES** when handling blades, knives, cutting edges or worn component with sharp edges.
  - Always **WEAR GLOVES** and **SAFETY GLASSES** when servicing hot components
  - **AVOID CONTACT** with hot hydraulic oil tanks, pumps, motors, valves and hose connection surfaces.
  - **SECURELY** support or **BLOCK UP** raised implement, framework and lifted components before working underneath equipment.
  - **FOLLOW INSTRUCTIONS** in maintenance section when replacing hydraulic cylinders to prevent component falling.
  - **STOP** any implement movements and **SHUT-OFF TRACTOR** engine before doing any work procedures.
  - **USE** ladder or raised stands to reach high equipment areas inaccessible from ground.
  - **ENSURE** good footing by standing on solid flat surfaces when getting on implement to perform work.
  - **FOLLOW** manufacturer's instructions in handling oils, solvents, cleansers, and other chemical agents.
  - **DO NOT** change any factory-set hydraulic calibrations to avoid component or equipment failures.
  - **DO NOT** modify or alter implement, functions or components.
  - **DO NOT WELD** or repair rotating mower components. These may cause vibrations and component failures being thrown from mower.

#### **PERFORM SERVICE, REPAIRS, LUBRICATION AND MAINTENANCE OUTLINED IN IMPLEMENT MAINTENANCE SECTION:**

- **INSPECT** for loose fasteners, worn or broken parts, leaky or loose fittings, missing or broken cotter keys and washers on pins, and all moving parts for wear.
- **REPLACE** any worn or broken parts with authorized service parts.
- Inspect mower blade spindle to ensure bearing preload. If loose repair before operating.
- **LUBRICATE** unit as specified by lubrication schedule
- **NEVER** lubricate, adjust or remove material while it is running or in motion.
- **TORQUE** all bolts and nuts as specified.

#### **BLADE INSPECTION:**

- Inspect blade carrier and blades daily.
- Check blade and blade carrier **BOLT TORQUE** daily. Loose bolts can cause blade or blade bolt failures.
- **REPLACE**, bent, damage, cracked and broken blades immediately with new blades.
- **AVOID** blade failures and thrown broken blades. **DO NOT** straighten, weld, or weld hard-facing blades.

#### **SAFETY SHIELDS, GUARDS AND SAFETY DEVICES INSPECTION:**

- **KEEP** all Deflectors, Chain Guards, Steel Guards, Gearbox Shields, and PTO integral shields, Bands, Side Skirts and Skid Shoes in place and in good condition.
- **REPLACE** any missing, broken or worn safety shields, guards and safety devices.
- Engine Exhaust, some of its constituents, and certain vehicle components contain or emit chemicals known to the state of California to cause cancer, birth defects or other reproductive harm.
- Battery posts, terminals and related accessories contain lead and lead compounds, chemicals known to the state of California to cause cancer, birth defects or other reproductive harm. **PN HMBM-01**



# SAFETY

## **PARTS INFORMATION**

### PARTS INFORMATION

Alamo Industrial mowers use balanced and matched system components for blade carriers, blades, cuttershafts, knives, knife hangers, rollers, drivetrain components, and bearings. These parts are made and tested to Alamo Industrial specifications. Non-genuine "will fit" parts do not consistently meet these specifications. The use of "will fit" parts may reduce mower performance, void mower warranties, and present a safety hazard. Use genuine Alamo Industrial mower parts for economy and safety. (SPAM-1)

**SEE YOUR ALAMO DEALER**

## **Decal Location**

**NOTE:** *Alamo Industrial supplies safety decals on this product to promote safe operation. Damage to the decals may occur while in shipping, use, or reconditioning. Alamo Industrial cares about the safety of its customers, operators, and bystanders, and will replace the safety decals on this product in the field, free of charge (Some shipping and handling charges may apply). Contact your Alamo Industrial dealer to order replacement decals.*

**SAFETY**

# SAFETY

SAFETY

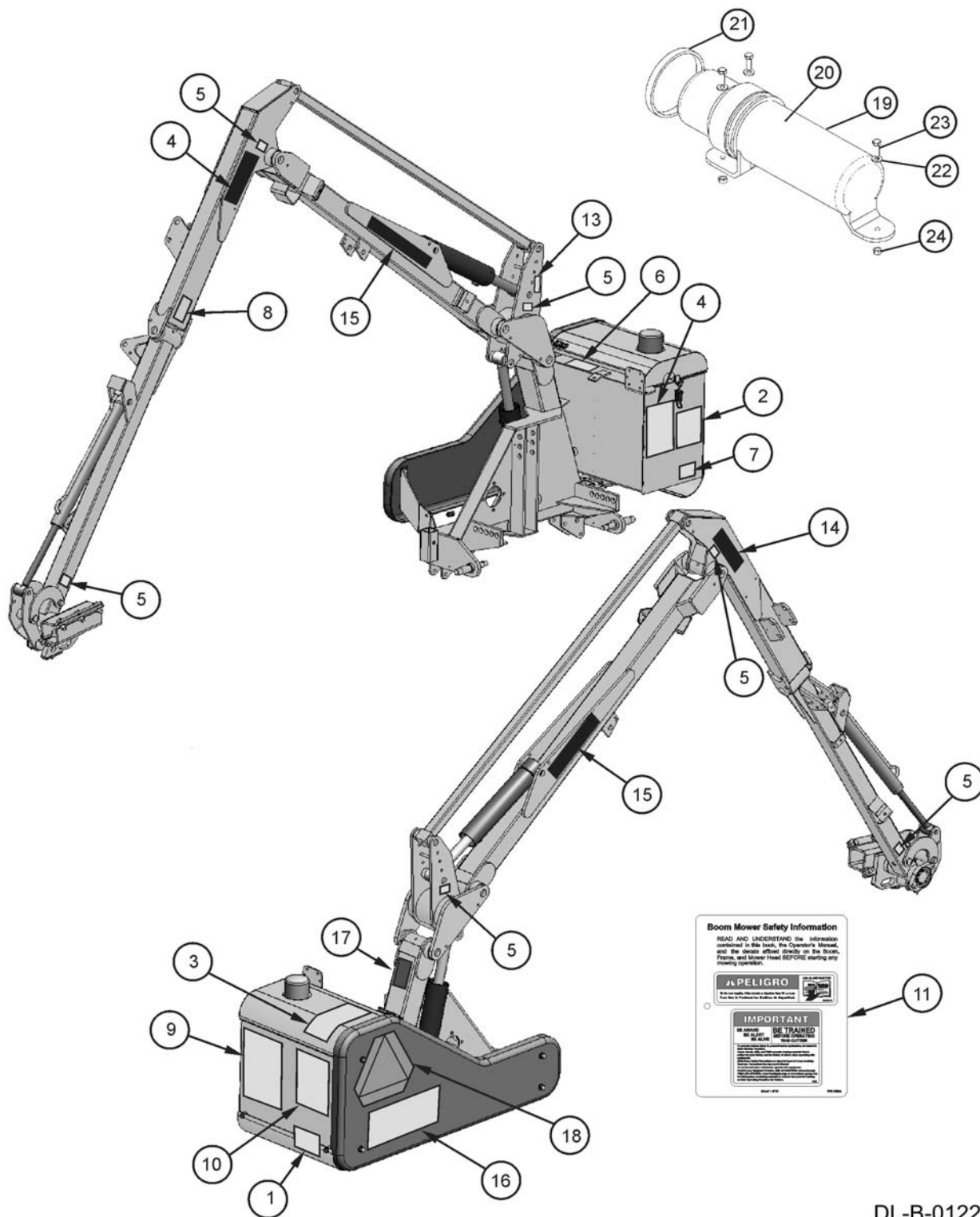

DL-B-0122

# SAFETY

**SAFETY**

ITEM	PART NO.	QTY.	TYPE	DESCRIPTION
1.	D628	1	DANGER	Crushing Hazard-Pinch Points
2.	D617	1	WARNING	Oil Leaks
3.	D618	1	WARNING	Boom Multi-Hazard
4.	D547	1	DANGER	Driveline Hazard
5.	D623	6	WARNING	Pinch Points
6.	D625	1	WARNING	Pressurized Tank
7.	D716	1	WARNING	Stabilizers in Position
8.	D719	1	DANGER	Keep Clear-Automatic Breakaway Return
9.	D721	1	DANGER	Multi-Hazard
10.	D722	1	DANGER	Entanglement Hazard
11.	D723	1	INSTRUCT	Lubrication Chart
12.	D677	1	INSTRUCT	Safety Booklet
13.	1290074	1	INSTRUCT	Sling Here
14.	1290530	2	LOGO	PA41
15.	00757139	1	LOGO	Alamo Industrial
16.	001650	1	LOGO	Alamo Industrial
17.	NFS	1	SER PLT	Serial Number Plate
18.	83380	1	REFLECTOR	SMV Sign
19.	46505.01	1	_____	Canister
20.	41486.50	1	_____	Operator's Manual (Inside Canister)

# SAFETY

**SAFETY**

## FLAIL HEAD

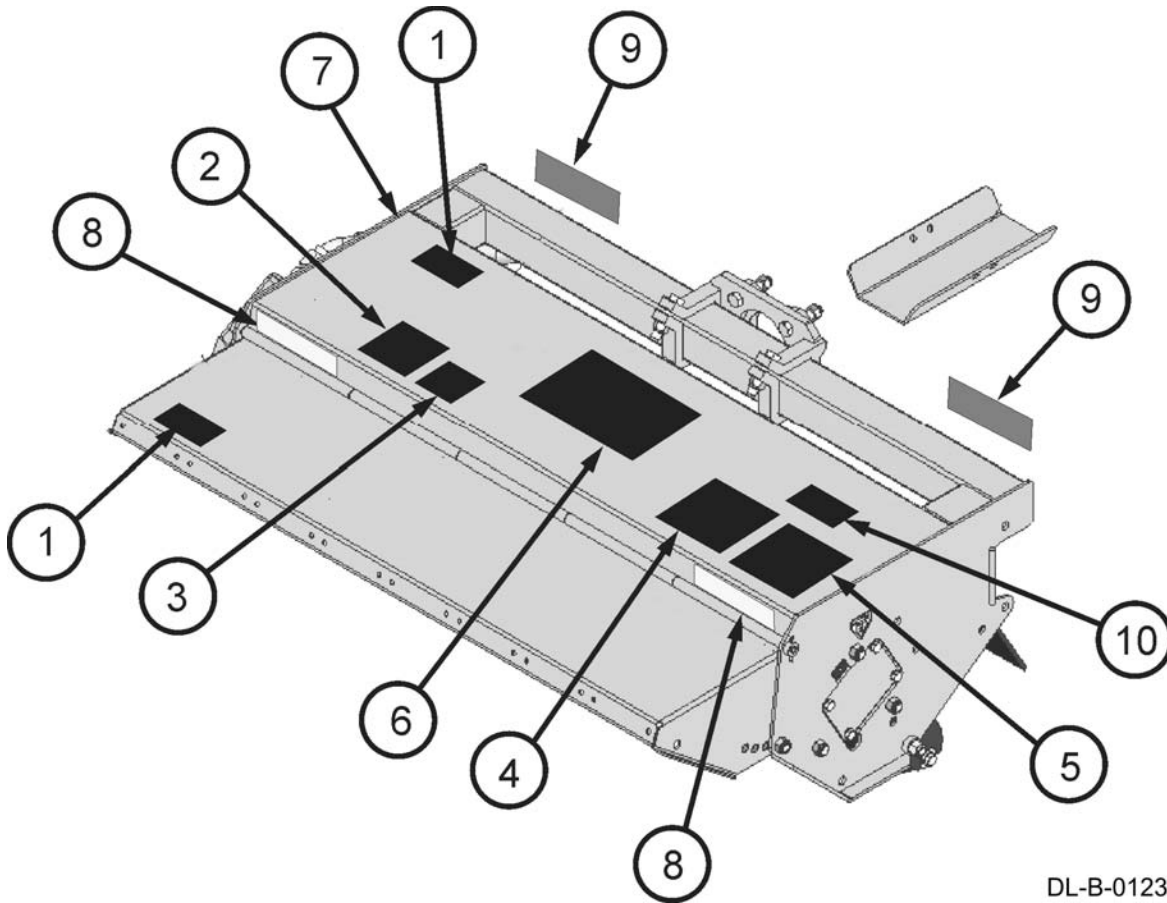





DL-B-0123



ITEM	PART NO.	QTY.	LEVEL	DESCRIPTION
1.	D626	2	DANGER	Maintain Deflectors in good condition
2.	D720	1	WARNING	Blade Bolt Torque
3.	D724	1	INSTRUCT	Lubrication Chart
4.	D564	1	WARNING	Alamo Industrial Genuine Parts
5.	D717	1	DANGER	Thrown Objects Hazard
6.	001650	1	LOGO	Alamo Industrial Logo
7.	NFS	1	SER PLT	Serial Number Plate
8.	1458393	2	REFLECTOR	Yellow Reflector
9.	1458392	1	REFLECTOR	Red Reflector
10.	D649	1	DANGER	Thrown Object Hazard

# SAFETY

SAFETY

## Decal Description

 <b>WARNING</b>	 <b>ADVERTENCIA</b>
<p><b>TO AVOID SERIOUS INJURY OR DEATH FROM HIGH PRESSURE HYDRAULIC OIL LEAKS PENETRATING SKIN:</b></p> <ul style="list-style-type: none"> <li>• DO NOT OPERATE equipment with oil or fuel leaks.</li> <li>• KEEP all hydraulic hoses, lines and connections in good condition and tight before applying system pressure.</li> <li>• Relieve hydraulic pressure before disconnecting lines or working on the system.</li> <li>• REMOVE and replace hose if you suspect it leaks. Have dealer test it for leaks.</li> </ul> <p><b>HIGH PRESSURE FLUID LEAKS CAN BE INVISIBLE. WHEN CHECKING FOR HYDRAULIC LEAKS AND WORKING AROUND HYDRAULIC SYSTEMS:</b></p> <ul style="list-style-type: none"> <li>• DO NOT use hands to check for leaks.</li> <li>• ALWAYS WEAR safety glasses and impenetrable gloves.</li> <li>• USE paper or cardboard to search for leaks.</li> <li>• KEEP hands and body AWAY from pin holes and nozzles ejecting hydraulic fluid.</li> <li>• Hydraulic fluid may cause gangrene if not surgically removed immediately by a doctor familiar with this form of injury.</li> </ul>	<div style="display: flex; flex-direction: column; align-items: center;">    </div> <p><b>PARA EVITAR LESION SERIA O MUERTE POR LA PENETRACION A LA PIEL POR ALTA PRESION DE ACEITE HIDRÁULICO:</b></p> <ul style="list-style-type: none"> <li>• NO OPERE el equipo con fugas de aceite o combustible.</li> <li>• MANTENGA todas las mangueras hidráulicas, líneas y conexiones en buenas condiciones y apretadas antes de aplicar presión al sistema.</li> <li>• Releve la presión hidráulica antes de desconectar las líneas o trabajar en le sistema.</li> <li>• QUITE y reemplace la manguera si sospecha que hay fuga.</li> </ul> <p><b>FUGAS DE ALTA PRESIÓN PUEDEN SER INVISIBLE. AL VERIFICAR POR FUGAS HIDRAULICAS Y TRABAJANDO ALREDEDOR DE SISTEMAS HIDRAULICOS:</b></p> <ul style="list-style-type: none"> <li>• NO use las manos para verificar si hay agujeros.</li> <li>• SIEMPRE USE lentes de seguridad y guantes impenetrables.</li> <li>• USE papel o un cartón para buscar agujeros.</li> <li>• NO USE las manos o partes del cuerpo para buscar agujeros.</li> <li>• MANTEGA manos y cuerpo LEJOS de agujeros de afiler y boquillas que expulsan el liquido hidráulicos.</li> </ul> <p style="text-align: right;">D617</p>

 <b>WARNING</b>	 <b>ADVERTENCIA</b>
<p><b>PRESSURIZED TANK</b> OIL FILLER CAP IS PRESSURE RELIEF CAP</p>	<p><b>TANQUE PRESURIZADO</b> LA TAPA DE DEPOSITO DE PETROLEO ES LA TAPA DE ALIVIO DE PRESIÓN.</p>
<p><b>TO AVOID SERIOUS INJURY AND DEATH FROM HOT OIL:</b></p> <ul style="list-style-type: none"> <li>• STAY AWAY from hot oil that may spray out of tank.</li> <li>• ALLOW oil to cool down BEFORE removing cap .</li> <li>• SLOWLY remove cap to relieve pressure BEFORE removing completely.</li> </ul>	<div style="display: flex; flex-direction: column; align-items: center;">  </div> <p><b>PARA EVITAR LESION SERIA O MUERTE POR ESCALDADURA DE PETROLEO CALIENTE:</b></p> <ul style="list-style-type: none"> <li>• MATENGASE ALEJADO del aciete caliente que puede salir a presión del tanque.</li> <li>• Remueva LENTAMENTE la tapa para relevar la presión ANTES de remover la tapa completamente.</li> <li>• PERMITA que el petróleo se enfríe ANTES de remover la tapa.</li> </ul> <p style="text-align: right;">D625</p>

# SAFETY

SAFETY

**⚠ WARNING**

**TO AVOID INJURY OR EQUIPMENT DAMAGE:**

- Make certain stabilizers and sway blocks are positioned to stabilize boom and prevent sideways motion.

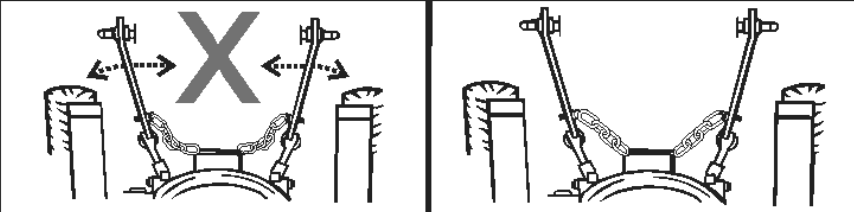

**⚠ ADVERTENCIA**

**PARA EVITAR LESION SERIA O DAÑO AL EQUIPO:**

- Asegurese de que los estabilizadores y los bloques estabilizadores estan en posicion para estabilizar el brazo y prevenir el movimiento lateral. D716

**⚠ DANGER**

**CRUSHING HAZARD AND PINCH POINTS**



**TO AVOID SERIOUS INJURY OR DEATH:**

- KEEP AWAY from moving machinery parts that can pinch, crush or fall.

**⚠ PELIGRO**





**RIESGOS DE APLASTAMIENTO Y PUNTOS DE PELLIZCO**





**PARA EVITAR LESION SERIA O MUERTE:**

- MANTENGASE ALEJADO de piezas moviles de la maquina que pueden peliscar, aplastar o caerse.

D628

# SAFETY

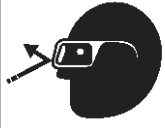
 <b>DANGER</b>	 <b>PELIGRO</b>	
<b>KEEP Bystanders AWAY THROWN OBJECTS HAZARD</b>	<b>MANTENGA las personas presentes LEJOS DE OBJETOS LANZADOS</b>	
<p>Mower can throw objects up to 300 feet. <b>TO AVOID SERIOUS INJURY OR DEATH to operator or bystanders:</b></p> <ul style="list-style-type: none"> <li>• STOP mowing if bystanders or traffic come within 300 feet.</li> <li>• DO NOT OPERATE with thrown object shielding removed.</li> <li>• KEEP thrown object shielding in place and in good condition during operation.</li> <li>• INSPECT area for potential mower thrown object hazards before mowing.</li> <li>• Remove and AVOID objects such as wire, cable, metal objects and all other foreign material.</li> <li>• DO NOT ALLOW blades to contact solid objects like wire, rocks, posts, curbs or guard rails.</li> </ul>	  	<p>Cortacésped puede lanzar objetos hasta 300 pies. <b>PARA EVITAR LESION SERIA O MUERTE a operadores y personas presentes:</b></p> <ul style="list-style-type: none"> <li>• Pare de segar si personas o tráfico se acercan entre 300 pies del area de segar.</li> <li>• NO OPERE sin la cubierta para objetos lanzados.</li> <li>• MANTENGA la cubierta para objeto lanzado en su lugar y en buenas condiciones.</li> <li>• INSPECCIONE el área por si hay riesgos potenciales de objetos lanzados antes de segar.</li> <li>• REMUEVA y EVITE objetos come alambre, cable, objetos de metal y todo otro material extranjero.</li> <li>• NO DEJE que las cuchillas contacten los objetos sólidos como alambre, rocas, postes, borde de banqueta, o barandillas.</li> </ul> <p style="text-align: right; font-size: small;">D721_1</p>

 <b>DANGER</b>	 <b>PELIGRO</b>	
<b>TO AVOID SERIOUS INJURY OR DEATH:</b>	<b>PARA EVITAR LESION SERIA O MUERTE:</b>	
<ul style="list-style-type: none"> <li>• READ AND UNDERSTAND the provided Operator's Manuals, safety signs and information decals for tractor and implement before operating equipment.</li> <li>• CONTACT DEALER immediately if you do not have manuals.</li> <li>• CONTACT DEALER to explain any instructions not fully understood.</li> <li>• KNOW HOW to stop tractor and equipment quickly for an emergency.</li> <li>• ALWAYS WEAR safety glasses.</li> <li>• WEAR hard hat, safety shoes and gloves for protection when operating equipment.</li> </ul>	   	<ul style="list-style-type: none"> <li>• LEA Y ENTIENDA el Manual de Operador proporcionado, signos de seguridad y calcomanias informativas para el tractor y implemento antes de operar el equipo.</li> <li>• CONTACTE AL DISTRIBUIDOR inmediatamente si no tiene los manuales.</li> <li>• CONTACTE AL DISTRIBUIDOR para que le explique cualquier instrucciones que no entiende completamente.</li> <li>• ENTIENDA COMO parar el tractor y equipo rapidamente en caso de emergencia.</li> <li>• SIEMPRE USE lentes de seguridad.</li> <li>• USE un casco, zapatos de seguridad y guantes para su protection cuando esta operando el equipo.</li> </ul> <p style="text-align: right; font-size: small;">D721_2</p>

# SAFETY



<b>DANGER</b>	<b>PELIGRO</b>
<b>Crushing Hazard Injury or Death</b>	<b>Riesgo de Aplastamiento Lesion o Muerte</b>
<p><b>TO AVOID SERIOUS INJURY OR DEATH:</b></p> <ul style="list-style-type: none"> <li>• USE tractor equipped with <b>Roll Over Protective Structure</b> ("ROPS") including roll bar and seat belt. Keep roll bar in raised position.</li> <li>• KEEP ALERT and AVOID hitting stumps, holes, ruts, and uneven terrain.</li> <li>• ALWAYS BUCKLE UP seat belt.</li> <li>• CLEAR AREA of bystanders before raising or lowering mower.</li> <li>• IMPLEMENT CAN FALL from hydraulic failure or accidental operation of controls.</li> <li>• BLOCK UP and securely support equipment before putting hands, feet or body under raised equipment or lifted components.</li> </ul>	<div style="display: flex; flex-direction: column; align-items: center;"> </div> <p><b>PARA EVITAR LESION SERIA O MUERTE:</b></p> <ul style="list-style-type: none"> <li>• USE un tractor equipado con Estructura Protectora Contra Vuelcos ("ROPS") incluyendo barra antivuelco y cinturón de seguridad. Mantenga la barra antivuelco en la posición elevada.</li> <li>• MANTENGASE ALERTO y EVITE golpes en troncos, agujeros, pozos o terreno en desnivel.</li> <li>• SIEMPRE ABROCHE el cinturón de seguridad.</li> <li>• DESOCUPE EL AREA de personas presentes antes de bajar o subir la unidad.</li> <li>• EL IMPLEMENTO SE PUEDE CAER por el mal funcionamiento hidráulico o operación accidental de los controles.</li> <li>• BLOQUEE y soporte con seguridad el equipo antes de poner manos, pies o cuerpo debajo del equipo o componentes levantados.</li> </ul> <p style="text-align: right; font-size: small;">D721_3</p>



<b>DANGER</b>	<b>PELIGRO</b>
<b>Run Over Hazard Injury or Death</b>	<b>Riesgo de Atropello Lesión o Muerte</b>
<p><b>TO AVOID SERIOUS INJURY OR DEATH:</b></p> <ul style="list-style-type: none"> <li>• ALWAYS USE <b>Roll Over Protective Structure</b> ("ROPS") including ROLL BAR and SEAT BELT equipped tractors for mowing operations.</li> <li>• ONLY START Tractor while seated in the operator's seat.</li> <li>• DO NOT MOUNT or DISMOUNT tractor in motion.</li> <li>• NEVER ALLOW riders on tractor or implement.</li> <li>• NEVER ALLOW children to operate or ride on tractor or implement.</li> <li>• KEEP BYSTANDERS CLEAR of area before moving tractor or implement.</li> <li>• STOP ENGINE AND PTO, engage parking brake, lower implement, allow all moving parts to stop and remove key before dismounting from tractor.</li> </ul>	<div style="display: flex; flex-direction: column; align-items: center;"> </div> <p><b>PARA EVITAR LESION SERIA O MUERTE:</b></p> <ul style="list-style-type: none"> <li>• SIEMPRE USE tractors equipados con una Estructura Protectora Contra Vuelcos ("ROPS") incluyendo BARRA ANTIMUELCOS y CINTURON DE SEGURIDAD al segar.</li> <li>• SOLO ENCIENDA el tractor mientras que esta sentado en el asiento del operador.</li> <li>• NO MONTE o DESMONTE el tractor en movimiento.</li> <li>• NUNCA PERMITA pasajeros en el tractor o implemento.</li> <li>• NUNCA PERMITA que niños operen o se monten en el tractor o implemento.</li> <li>• MANTENGA LAS PERSONAS PRESENTES LEJOS de la area antes de mover el tractor o implemento.</li> <li>• PARE EL MOTOR Y PTO, aplique el freno de mano, baje el implemento, y deje que todas las partes móvil paren completamente, y quite la llave antes de desmontar el tractor.</li> </ul> <p style="text-align: right; font-size: small;">D721_4</p>

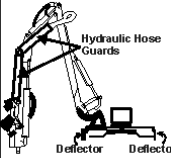

# SAFETY

**SAFETY**

<b>! DANGER</b>	<b>! PELIGRO</b>
<p><b>TO AVOID SERIOUS INJURY OR DEATH FROM THROWN OBJECTS:</b></p> <ul style="list-style-type: none"> <li>• DO NOT OPERATE with guards or thrown object shielding missing.</li> <li>• Thrown objects shielding, hydraulic hose guards and hydraulic hose sleeves are SUBJECT TO WEAR.</li> <li>• REPAIR OR REPLACE guards and thrown object shielding if damaged, broken or missing.</li> <li>• ALWAYS REPLACE GUARDS that have been removed for service or maintenance.</li> <li>• DO NOT operate without operator protective shielding or cab.</li> </ul>	<p><b>PARA EVITAR LESION SERIA O MUERTE POR ACIETE HIDRÁULICO O OBJETOS LANZADOS:</b></p> <ul style="list-style-type: none"> <li>• NO OPERE sin las cubiertas de objetos lanzados o si faltan las mayas protectora hidraulicas.</li> <li>• Las cubiertas de objetos lanzados, las mayas protectoras hidraulicas, y las mangas de mangueras hidraulicas son SUJETAS AL DESGASTE.</li> <li>• REPARE O REEMPLACE cubiertas si son dañadas, quebradas, o si faltan.</li> <li>• SIEMPRE REEMPLACE cubiertas que han sido quitadas para servicio o mantenimiento.</li> <li>• NO opere sin las cubiertas protectoras del operador o cabina.</li> </ul>
	
	
	D616_5



<b>! DANGER</b>	<b>! PELIGRO</b>
Entanglement Hazard	Riesgo de Enredamiento
<p><b>TO AVOID SERIOUS INJURY OR DEATH:</b></p> <ul style="list-style-type: none"> <li>• DO NOT operate without guards in place and in good condition.</li> <li>• STAY AWAY and KEEP hands, feet and body AWAY from rotating blades, drivelines and parts that continue to move after power shut-off. WAIT until all moving elements have stopped.</li> <li>• STOP, LOOK and LISTEN for rotating motion before approaching implement.</li> <li>• STOP ENGINE and PTO, engage parking brake, lower mower to ground, allow all moving parts to stop and remove key before dismantling from tractor.</li> </ul>	<p><b>PARA EVITAR LESION SERIA O MUERTE:</b></p> <ul style="list-style-type: none"> <li>• NO opere sin la cubierta protectora en su lugar y en buen estado.</li> <li>• MANTENGASE ALEJADO y MANTENGA manos, pies y cuerpo LEJOS de las cuchillas girando, líneas de conducción, y partes que siguen moviendose después de que el poder es apagado. ESPERE hasta que todos los elementos móviles se han parado.</li> <li>• DETENGASE, OBSERVE y ESCUCHE por el movimiento de rotación antes de acercarse al implemento.</li> <li>• PARE EL MOTOR y el PTO, active el freno de mano, baje el implemento, y permita que todas las partes móviles se paren y quite la llave antes de desmontar el tractor.</li> </ul>
	
	
	D616_6      D616



# SAFETY



SAFETY

<b>⚠ DANGER</b>		<b>⚠ PELIGRO</b>	
<p><b>TO AVOID SERIOUS INJURY OR DEATH FROM DRIVELINE CONTACT, DRIVELINE SEPARATION OR PTO STUB SHAFT FAILURE:</b></p> <ul style="list-style-type: none"> <li>• STOP, LOOK and LISTEN for rotating motion before approaching implement.</li> <li>• STAY AWAY and KEEP hands, feet and body AWAY from rotating parts until all moving elements have stopped.</li> <li>• ALWAYS shut off PTO before dismounting.</li> <li>• DO NOT operate if PTO shields are damaged or missing.</li> <li>• LOCK DRIVELINE locking collar YOKE to tractor PTO Shaft.</li> <li>• PUSH AND PULL on yoke until collar clicks and locks yoke in place.</li> <li>• USE CORRECT length drivelines for implement. (See Operator's Manuals for procedure)</li> <li>• CHECK driveline guards for free rotation and sufficient overlap to avoid unshielded areas.</li> <li>• DO NOT USE PTO ADAPTER</li> </ul>	  <p>PTO (Barra Giteratoria)</p>  <p>BOTTOMING OUT</p> 	<p><b>PARA EVITAR LESION SERIA O MUERTE POR CONTACTO A LA LÍNEA DE CONDUCCIÓN, SEPARACION DE LÍNEA DE CONDUCCIÓN O EL FRACASO DEL EJE DE PTO:</b></p> <ul style="list-style-type: none"> <li>• PARE, MIRE y ESCUCHE por el movimiento de rotación antes de acercarse al implemento.</li> <li>• MANTENGASE ALEJADO y MANTENGA manos, pies y cuerpo LEJOS de partes girando, hasta que todos los elementos de movimiento se han parado.</li> <li>• SIEMPRE apague la Toma De Fuerza (Barra Giteratoria) antes de desmontar.</li> <li>• NO opere si las cubiertas de Toma De Fuerza (Barra Giteratoria) estan dañadas.</li> <li>• TRABE el YUGO de collar de fijación del la LÍNEA DE CONDUCCIÓN al eje de PTO (Barra Giteratoria) del tractor.</li> <li>• EMPUJE Y JALE el yugo hasta que el collar de fijación hace clic y el yugo se traba en lugar.</li> <li>• USE la longitud de línea de conducción CORRECTA para el implemento. (Vea el Manual de Operador para el Procedimiento)</li> <li>• REVISE las guardias de línea de conducción por giracion libre y suficiente traslape para evitar areas sin cobertura.</li> <li>• NO UTILICE UN ADAPTOR PARA LA TOMA DE FUERZA (Barra Giteratoria).</li> </ul>	<p>D547-1</p>
<b>⚠ WARNING</b>		<b>⚠ ADVERTENCIA</b>	
<p>OPERATE THIS MACHINE AT <b>540 RPM</b></p> <p>TRACTOR PTO SPEED ONLY. Overspeeding PTO may cause component failure resulting in bodily injury. TRACTOR PTO ROTATION: CLOCKWISE</p>		<p>OPERE ESTA MÁQUINA A <b>540 RPM</b></p> <p>SOLAMENTE OPERE ESTA MÁQUINA A LA VELOCIDAD DE PTO (TOMA DE FUERZA O BARRA GITATORIA) DEL TRACTOR DE 540 RPM. El sobre exceso de velocidad de PTO puede causar el fracaso de componente que resultara en lesión. ROTACION DE PTO DEL TRACTOR: EN SENTIDO HORARIO</p>	<p>D547</p>

# SAFETY











 <b>WARNING</b>	 <b>ADVERTENCIA</b>
<p><b>TO AVOID SERIOUS INJURY AND DEATH DURING TRANSPORTATION:</b></p> <ul style="list-style-type: none"> <li>• ALWAYS BUCKLE UP seat belt.</li> <li>• PLACE boom securely in Transport Rest and turn off master switch.</li> <li>• CHECK SMV sign, reflectors and warning lights for visibility behind unit.</li> <li>• TURN ON tractor flashing warning lights.</li> </ul> <p><b>TO AVOID LOSS OF TRANSPORTATION CONTROL:</b></p> <ul style="list-style-type: none"> <li>• DO NOT travel at speeds over 20 mph.</li> <li>• REDUCE SPEED on inclines, in turns and in poor weather conditions.</li> </ul>	<div data-bbox="716 344 911 674" data-label="Image"> </div> <div data-bbox="716 674 911 877" data-label="Image"> </div> <p><b>PARA EVITAR LESION SERIA Y MUERTE DURANTE LA TRANSPORTACION:</b></p> <ul style="list-style-type: none"> <li>• SIEMPRE ABROCHE el cinturón de seguridad.</li> <li>• COLOQUE el brazo seguramente en transporte y apague el interruptor principal.</li> <li>• VERIFIQUE QUE EL SMV, reflectors, y luces intermitentes de advertencia pueden ser vistos claramente por detras de la unidad.</li> <li>• PRIENDA las luces intermitentes de advertencia.</li> </ul> <p><b>PARA EVITAR LA PÉRDIDA DEL CONTROL DE TRANSPORTACION:</b></p> <ul style="list-style-type: none"> <li>• NO remolque en velocidades arriba de 20 mph.</li> <li>• REDUZCA LA VELOCIDAD en inclinas, en vueltas y en pobres condiciones de remolque.</li> </ul> <p style="text-align: right;">D618_1</p>

 <b>WARNING</b>	 <b>ADVERTENCIA</b>
<p><b>TO AVOID SERIOUS INJURY AND DEATH DURING OPERATION:</b></p> <ul style="list-style-type: none"> <li>• DO NOT lift implement while on steep slopes.</li> <li>• KEEP AWAY from soft ditch banks and holes.</li> <li>• ALWAYS MAINTAIN 1500 pounds of contact between wheels and surface. Widen wheel tread or add weight if needed. (see Operator's Manual)</li> <li>• ALWAYS MAINTAIN 20% of tractor weight on front wheels.</li> <li>• DO NOT start or accelerate suddenly.</li> <li>• KEEP mower AT LEAST 10 FEET AWAY from electric lines and pipe lines.</li> </ul>	<div data-bbox="716 997 911 1102" data-label="Image"> </div> <div data-bbox="716 1102 911 1207" data-label="Image"> </div> <div data-bbox="716 1207 911 1312" data-label="Image"> </div> <div data-bbox="716 1312 911 1465" data-label="Image"> </div> <p><b>PARA EVITAR LESION SERIA Y MUERTE DURANTE LA OPERACION:</b></p> <ul style="list-style-type: none"> <li>• NO levante el implemento al estar en pendientes pronunciados..</li> <li>• MANTENGASE ALEJADO DE agujeros y zanjas blandas..</li> <li>• SIEMPRE MANTENGA 1500 libras de contacto entre las llantas y tierra. Amplie el rodamiento de la llanta o agreguele peso si es necesario. (Vea el Manual de Operadores)</li> <li>• MANTENGA SIEMPRE el 20% de peso del tractor en las ruedas delanteras.</li> <li>• NO comience ni acelere repentinamente.</li> <li>• MANTENGA la unidad, por lo menos 10 pies de distancia de las líneas electricas y líneas de tubo.</li> </ul> <p style="text-align: right;">D618_2</p>

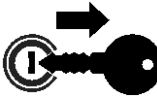
 <b>WARNING</b>	 <b>ADVERTENCIA</b>
<p><b>TO AVOID EQUIPMENT AND GRASS FIRES:</b></p> <ul style="list-style-type: none"> <li>• CLEAR AWAY grass or debris from hydraulic lines, circuits and decks.</li> </ul> <p><b>TO AVOID FIRE IGNITION:</b></p> <ul style="list-style-type: none"> <li>• DO NOT ALLOW BLADES TO CONTACT rocks, metal or solid objects.</li> <li>• DO NOT ALLOW OIL TO SPRAY on hot equipment or components.</li> </ul>	<div data-bbox="716 1583 911 1787" data-label="Image"> </div> <p><b>PARA EVITAR INCENDIOS DE EQUIPO Y CÉSPED:</b></p> <ul style="list-style-type: none"> <li>• QUITE el césped y escombros de las líneas hidraulicas, circuito, y las cubiertas.</li> </ul> <p><b>PARA EVITAR INCENDIOS POR IGNICIÓN:</b></p> <ul style="list-style-type: none"> <li>• NO PERMITA QUE LAS CUCHILLAS CONTACTEN piedras, metal o objetos solidos.</li> <li>• NO PERMITA QUE EL ACEITE CAIGA en el equipo o componentes calientes.</li> </ul> <p style="text-align: right;">D618</p>

# SAFETY

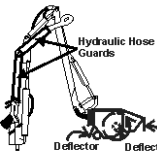
SAFETY

 <b>DANGER</b>	 <b>PELIGRO</b>
Entanglement Hazard	Riesgo de Enredamiento
<p><b>TO AVOID SERIOUS INJURY OR DEATH:</b></p> <ul style="list-style-type: none"> <li>• DO NOT operate without guards in place and in good condition.</li> <li>• STAY AWAY and KEEP hands, feet and body AWAY from rotating blades, drivelines and parts that continue to move after power shut-off. WAIT until all moving elements have stopped.</li> <li>• STOP, LOOK and LISTEN for rotating motion before approaching implement.</li> <li>• STOP ENGINE and PTO, engage parking brake, lower mower to ground, allow all moving parts to stop and remove key before dismantling from tractor.</li> </ul>	   <p>D722_2      D722</p>
<p><b>PARA EVITAR LESION SERIA O MUERTE:</b></p> <ul style="list-style-type: none"> <li>• NO opere sin la cubierta protectora en su lugar y en buen estado.</li> <li>• MANTENGASE ALEJADO y MANTENGA manos, pies y cuerpo LEJOS de las cuchillas girando, líneas de conducción, y partes que siguen moviéndose después de que el poder es apagado. ESPERE hasta que todos los elementos móviles se han parado.</li> <li>• DETENGASE, OBSERVE y ESCUCHE por el movimiento de rotación antes de acercarse al implemento.</li> <li>• PARE EL MOTOR y el PTO, active el freno de mano, baje el implemento, y permita que todas las partes móviles se paren y quite la llave antes de desmontar el tractor.</li> </ul>	
 <b>DANGER</b>	 <b>PELIGRO</b>
<p><b>TO AVOID SERIOUS INJURY OR DEATH FROM THROWN OBJECTS:</b></p> <ul style="list-style-type: none"> <li>• DO NOT OPERATE with guards or thrown object shielding missing.</li> <li>• Thrown objects shielding, hydraulic hose guards and hydraulic hose sleeves are SUBJECT TO WEAR.</li> <li>• REPAIR OR REPLACE guards and thrown object shielding if damaged, broken or missing.</li> <li>• ALWAYS REPLACE GUARDS that have been removed for service or maintenance.</li> <li>• DO NOT operate without operator protective shielding or cab.</li> </ul>	   <p>D722_1</p>
<p><b>PARA EVITAR LESION SERIA O MUERTE POR ACIETE HIDRÁULICO O OBJETOS LANZADOS:</b></p> <ul style="list-style-type: none"> <li>• NO OPERE sin las cubiertas de objetos lanzados o si faltan las mayas protectora hidráulicas.</li> <li>• Las cubiertas de objetos lanzados, las mayas protectoras hidráulicas, y las mangas de mangueras hidráulicas son SUJETAS AL DESGASTE.</li> <li>• REPARE O REEMPLACE cubiertas si son dañadas, quebradas, o si faltan.</li> <li>• SIEMPRE REEMPLACE cubiertas que han sido quitadas para servicio o mantenimiento.</li> <li>• NO opere sin las cubiertas protectoras del operador o cabina.</li> </ul>	

# SAFETY

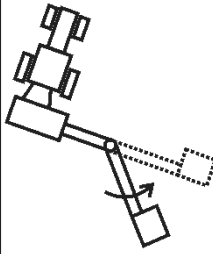
<b>⚠ DANGER</b>		<b>⚠ PELIGRO</b>
<b>KEEP AWAY</b> AUTOMATIC BREAKAWAY RETURN Keep clear of the front of the arm and head.		<b>MANTEGASE ALEJADO DESMONTABLE DE REGRESO AUTOMATICO</b> Mantégase alejado de la parte delantera del brazo y cabeza.

D719

<b>⚠ DANGER</b>	<b>⚠ PELIGRO</b>
<b>THROWN OBJECTS HAZARD</b>	<b>RIESGO DE OBJETOS LANZADOS</b>
<p>Mower can throw objects up to 300 feet. TO AVOID SERIOUS INJURY OR DEATH to operator or bystanders:</p> <ul style="list-style-type: none"> <li>• DO NOT operate with Shield removed.</li> <li>• KEEP Shield in place and in good condition during operation.</li> </ul>	<p style="text-align: center;"></p> <p>Cortacésped puede lanzar objetos hasta 300 pies. PARA EVITAR LESION SERIA O MUERTE a operadores y personas presentes:</p> <ul style="list-style-type: none"> <li>• NO opere con la Cubierta quitada.</li> <li>• MANTENGA la Cubierta en su lugar y en buen estado durante la operacion.</li> </ul>

D649

<b>⚠ WARNING</b>
<b>PINCH POINTS</b>

<b>⚠ ADVERTENCIA</b>
<b>PUNTO DE PELLIZCO</b>

D623

# SAFETY

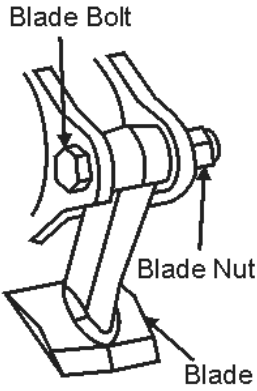
⚠ <b>WARNING</b>		⚠ <b>ADVERTENCIA</b>	
<p><b>TO AVOID SERIOUS INJURY OR DEATH FROM BLADE ATTACHMENT FAILURE:</b></p> <ul style="list-style-type: none"> <li>• Check blade bolts DAILY for tightness.</li> <li>• Torque blade bolt to 150 ft lbs.</li> <li>• ALWAYS replace blades with new bolts and nuts.</li> </ul>		<p><b>PARA EVITAR LESION SERIA O MUERTE POR EL FALLO DEL ACOPLAMIENTO DE LAS CUCHILLAS:</b></p> <ul style="list-style-type: none"> <li>• Verifique los tornillos de las cuchillas DIARIAMENTE para si estan apretados.</li> <li>• Apriete los tornillos a torsión de 150 libras pie.</li> <li>• SIEMPRE reemplace las cuchillas con tornillos y tuercas nuevas. D720</li> </ul>	

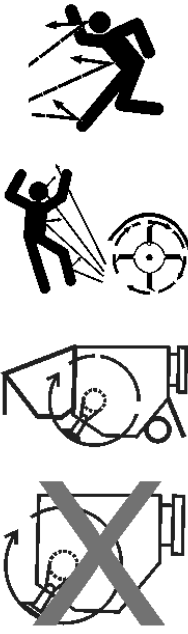
⚠ <b>DANGER</b>		⚠ <b>PELIGRO</b>	
THROWN OBJECTS HAZARD		RIESGO DE OBJETOS LANZADOS	
<p><b>Mower can throw objects up to 300 feet. TO AVOID SERIOUS INJURY OR DEATH to operator or bystanders:</b></p> <ul style="list-style-type: none"> <li>• CLOSE MOWER DOOR and STOP operating if bystanders or traffic come within 300 feet.</li> <li>• KEEP door fully closed when cutting grass and weeds.</li> <li>• OPEN door ONLY to cut large brush. Keep door closed for all other mowing conditions.</li> <li>• Deflectors are SUBJECT TO WEAR. Replace if worn or damaged.</li> <li>• ALWAYS transport with door closed.</li> </ul> <p><b>IF MOWER DOOR IS OPEN:</b></p> <ul style="list-style-type: none"> <li>• DO NOT OPERATE if blades are rotating in reverse rotation (opposite to the tractor tires during forward travel).</li> </ul>		<p><b>Cortacésped puede lanzar objetos hasta 300 pies. PARA EVITAR LESION SERIA O MUERTE a operadores y personas presentes:</b></p> <ul style="list-style-type: none"> <li>• CIERRE LA PUERTA DE LA UNIDAD y PARE de operar si las personas presentes o el trafico se acercan entre 300 pies de la unidad.</li> <li>• MANTENGA la puerta completamente cerrada al cortar zacate o hierbas.</li> <li>• ABRA SOLO la puerta para cortar ramas grandes. Mantenga la puerta cerada en todas las otras condiciones de segar.</li> <li>• Los Deflectores son SUJETOS AL DESGASTE. Reemplace si estan desgastados o dañados.</li> <li>• SIEMPRE transporte con la puerta cerrada.</li> </ul> <p><b>SI LA PUERTA DE LA CORTADORA ESTA ABIERTA:</b></p> <ul style="list-style-type: none"> <li>• NO OPERE si las cuchillas estan girando en la rotación reversa (opuesto a las llantas del tractor durante el avance de viaje). D717</li> </ul>	

# SAFETY

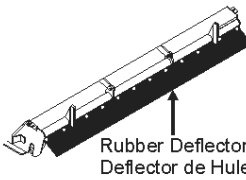
<b>⚠ DANGER</b>	<b>⚠ PELIGRO</b>
<b>THROWN OBJECT HAZARD</b>	<b>RIESGO DE OBJETOS LANZADOS</b>
<p><b>TO AVOID SERIOUS INJURY OR DEATH:</b> DO NOT OPERATE if Thrown Object Shielding is damaged or missing.</p> <ul style="list-style-type: none"> <li>• Maintain Rubber Deflectors in good condition.</li> <li>• Inspect Rubber Deflectors frequently.</li> </ul>	<p><b>PARA EVITAR LESION SERIA O MUERTE:</b> NO OPERE si la Cubierta de Objetos Lanzados esta dañada o falta.</p> <ul style="list-style-type: none"> <li>• Mantenga Los Deflectores de Hule en buenas condiciones.</li> <li>• Inspeccione Los Deflectores de Hule con frecuencia.</li> </ul>
 <p>Rubber Deflector Deflector de Hule</p>	
<small>D626</small>	

<b>⚠ WARNING</b>	<b>⚠ ADVERTENCIA</b>
<p><b>Non-genuine parts can fail catastrophically.</b> <b>TO AVOID SERIOUS INJURY OR DEATH:</b></p> <ul style="list-style-type: none"> <li>• ONLY use genuine ALAMO INDUSTRIAL replacement parts.</li> <li>• Non-genuine parts can fail creating hazardous conditions for operator and bystanders.</li> </ul> <p>Contact local dealer or ALAMO INDUSTRIAL about repair parts at:</p> <p>1502 E. Walnut, Seguin, TX 78155. Customer Service: 800-882-5762. Email: support@alamo-industrial.com</p>	<p><b>Partes que no son auténticas pueden fallar catastróficamente.</b> <b>PARA EVITAR LESION SERIA O MUERTE:</b></p> <ul style="list-style-type: none"> <li>• Use SOLAMENTE las partes de reemplazo auténticas de ALAMO INDUSTRIAL.</li> <li>• Partes que no son auténticas pueden fallar y causar condiciones peligrosas para el operador y personas presentes.</li> </ul> <p>Contacte a su distribuidor local o ALAMO INDUSTRIAL sobre partes de reparo a:</p> <p>1502 E. Walnut, Seguin, TX 78155. Servicio al Cliente: 800-882-5762. Correo Electronico: support@alamo-industrial.com</p>
<small>D564_1</small>	

<b>IMPORTANT</b>	<b>IMPORTANTE</b>
<p><b>BE AWARE      <u>BE TRAINED</u></b> <b>BE ALERT      Before Operating</b> <b>BE ALIVE      this Mower</b></p>	<p><b>ESTE CONSCIENTE      <u>SEA ENTRENADO</u></b> <b>ESTE ALERTO      Antes de Funcionar</b> <b>ESTE VIVO      Cortacésped</b></p>
<p>To prevent serious injury to yourself and/or bystanders, be trained in Safe Mowing Practices.</p> <p>Alamo Group Companies, Alamo Industrial, Bush Hog, M&amp;W, Rhino, Schulte, Tiger and Terrain King as well as AEM and FEMA provide training material that is critical for your Safety and the Safety of others when operating this equipment. Make these Safety Procedures an important part of every workday.</p> <p>Read and understand the Operator's Manual.</p> <p>Do not let untrained individuals operate this equipment.</p> <p>Contact your Dealer, AEM (<a href="http://www.aem.org">www.aem.org</a>), FEMA (314-878-2304, <a href="http://www.FarmEquipment.org">www.FarmEquipment.org</a>), or Alamo Group (<a href="http://www.Alamo-Group.com">www.Alamo-Group.com</a>) for information on training material or courses that provide training in Safer Operating Practices for Mowers.</p>	<p>Para prevenir lesiones graves a usted y/o personas presentes, sea entrenado en la Practica de Segar Seguro.</p> <p>Companias de Alamo Group, Alamo Industrial, Bush Hog, M&amp;W, Rhino, Schulte, Tiger y Terrain King asi como AEM y FEMA proporcionan material para entrenar que es esencial para su seguridad y la seguridad de otros al operar este equipo. Haga estos procedimientos de seguridad una parte importante de su dia de trabajo.</p> <p>Lea y entienda el Manual de Operadores.</p> <p>No permita que personas sin entrenamiento funcionen este equipo.</p> <p>Contacte a su distribuidor, AEM (<a href="http://www.aem.org">www.aem.org</a>), FEMA (314-878-2304, <a href="http://www.FarmEquipment.org">www.FarmEquipment.org</a>), o Alamo Group (<a href="http://www.Alamo-Group.com">www.Alamo-Group.com</a>) para la informacion sobre el material de entrenamiento o cursos que ofrecen el entenamiento de Prácticas de Operación para Cortadoras.</p>
<small>D564_2</small>	

# SAFETY

## Federal Laws and Regulations

This section is intended to explain in broad terms the concept and effect of federal laws and regulations concerning employer and employee equipment operators. This section is not intended as a legal interpretation of the law and should not be considered as such.

### Employer-Employee Operator Regulations

U.S. Public Law 91-596 (The Williams-Steiger Occupational and Health Act of 1970) OSHA

#### This Act Seeks:

“...to assure so far as possible every working man and woman in the nation safe and healthful working conditions and to preserve our human resources...”

#### DUTIES

Sec. 5 (a) Each employer-

- (1) shall furnish to each of his employees employment and a place of employment which are free from recognized hazards that are causing or are likely to cause death or serious physical harm to his employees;
- (2) shall comply with occupational safety and health standards promulgated under this Act.
- (b) Each employee shall comply with occupational safety and health standards and all rules, regulations and orders issued pursuant to this Act which are applicable to his own actions and conduct.

### OSHA Training Requirements

**Title 29, Code of Federal Regulations Part 1928.57(a)(6). [www.osha.gov](http://www.osha.gov)**

Operator instructions. At the time of initial assignment and at least annually thereafter, the employer shall instruct every employee who operates an agricultural tractor and implements in the safe operating practices and servicing of equipment with which they are or will be involved, and of any other practices dictated by the work environment.

Keep all guards in place when the machine is in operation;

Permit no riders on equipment

Stop engine, disconnect the power source, and wait for all machine movement to stop before servicing, adjusting, cleaning or unclogging the equipment, except where the machine must be running to be properly serviced or maintained, in which case the employer shall instruct employees as to all steps and procedures which are necessary to safely service or maintain the equipment.

Make sure everyone is clear of machinery before starting the engine, engaging power, or operating the machine.

### Employer Responsibilities:

To ensure employee safety during Tractor and Implement operation, it is the employer's responsibility to:

1. Train the employee in the proper and safe operation of the Tractor and Implement.
2. Require that the employee read and fully understand the Tractor and Implement Operator's manual.
3. Permit only qualified and properly trained employees to operate the Tractor and Implement.
4. Maintain the Tractor and Implement in a safe operational condition and maintain all shields and guards on the equipment.
5. Ensure the Tractor is equipped with a functional ROPS and seat belt and require that the employee operator securely fasten the safety belt and operate with the ROPS in the raised position at all times.
6. Forbid the employee operator to carry additional riders on the Tractor or Implement.
7. Provide the required tools to maintain the Tractor and Implement in a good safe working condition and provide the necessary support devices to secure the equipment safely while performing repairs and service.
8. Require that the employee operator stop operation if bystanders or passersby come within 300 feet.

### Child Labor Under 16 Years of Age

Some regulations specify that no one under the age of 16 may operate power machinery. It is your responsibility to know what these regulations are in your own area or situation. (Refer to U.S. Dept. of Labor, Employment Standard Administration, Wage & Home Division, Child Labor Bulletin #102.)



INDUSTRIAL/  
AGRICULTURAL MOWER

[www.aem.org](http://www.aem.org)



# SAFETY MANUAL

FOR OPERATING AND MAINTENANCE PERSONNEL

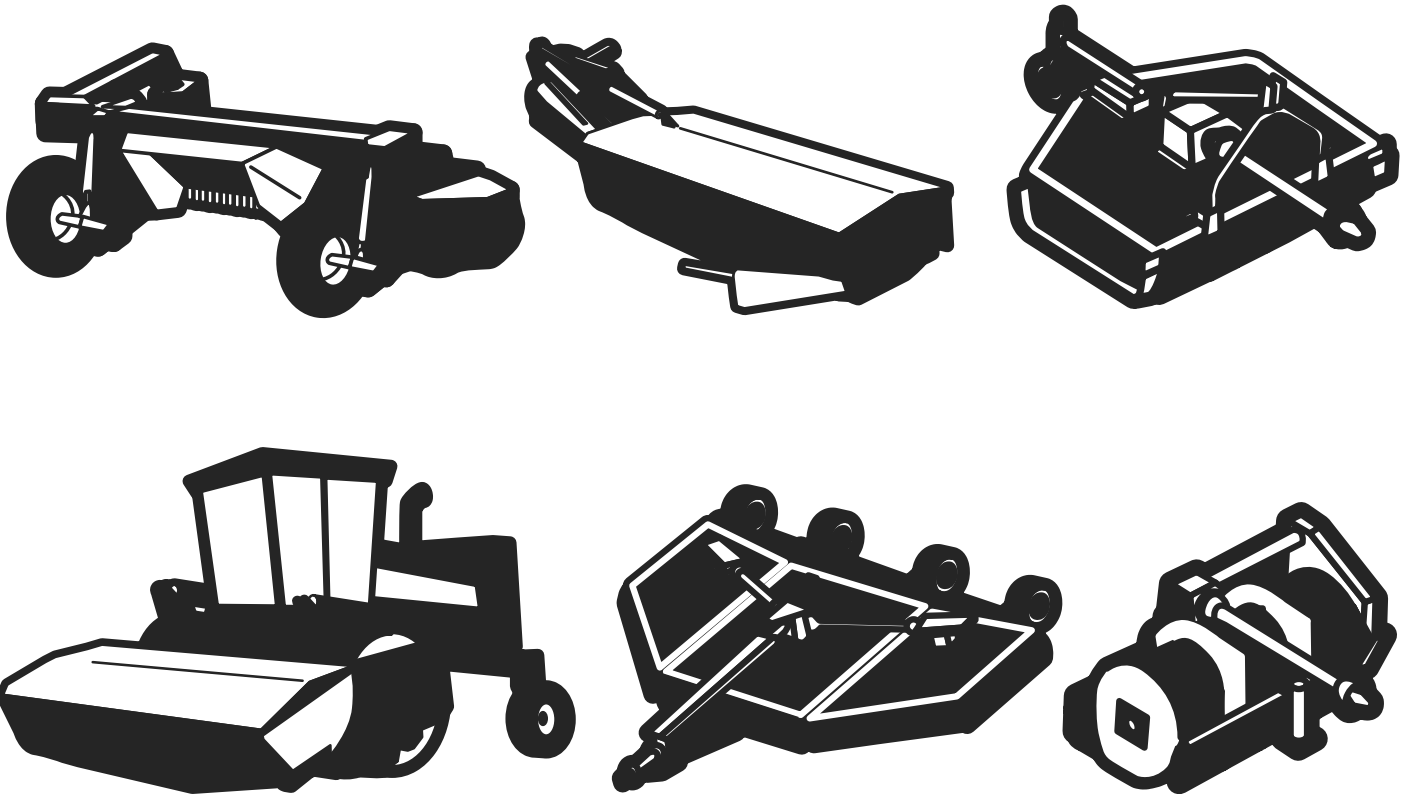

# Contents

Acknowledgment .....	2
Foreword .....	2
Safety Alerts .....	3
A Word To The User/Operator .....	3
The Industrial/Agricultural Mower .....	4
Follow A Safety Program .....	5
Prepare For Safe Operation .....	9
Start Safely .....	13
Operate Safely .....	13
Park Safely .....	18
Shut Down Safely .....	18
Perform Maintenance Safely .....	19
Final Word To The User .....	26

## Acknowledgment

We wish to acknowledge the contributions of the members of AEM's Industrial/Agricultural Mower Manufacturers Council to the preparation of this Safety Manual.

### NOTICE OF COPYRIGHT PROTECTION

Copyright, 2010, by the Association of Equipment Manufacturers. All rights reserved. This work may not be reproduced or disseminated in whole or in part by any means without the prior written permission of the Association of Equipment Manufacturers.

Copyright 2010© AEM (Association of Equipment Manufacturers)  
Revised 01/03, 09/10

## Foreword

This safety manual is intended to point out some of the basic safety situations that may be encountered during the normal operation and maintenance of your machine and to instruct you in safety practices for dealing with these conditions. This manual is **NOT** a substitute for the mower manufacturer's operator's manual(s).

Additional precautions may be necessary, or some instructions may not apply, depending on equipment, attachments and conditions at the worksite or in the service area. The manufacturer has no direct control over equipment application, operation, inspection or maintenance. Therefore, it is **YOUR** responsibility to use good safety practices in these areas.

The information provided in this manual supplements the specific information about your machine that is contained in the manufacturer's operator's manual(s). Other information that may affect the safe operation of your machine may be contained on safety signs or in insurance requirements, employer's safety and training programs, safety codes, local, state/provincial and federal laws, rules and regulations.

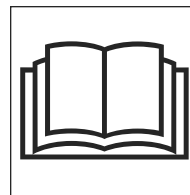

**IMPORTANT!** Before you operate the mower, make sure you have the manufacturer's operator's manual(s) for this machine and all attachments. If the manufacturer's manuals are missing, obtain replacement manuals from your employer, equipment dealer or directly from the manufacturer. Keep this safety manual and the manufacturer's manuals with the machine at all times. Read and understand all manuals.

The AEM Mower Safety Practices video is available to train and reinforce good safety practices. Operators are encouraged to periodically view the safety video.

# Safety Alerts

## Symbol

This Safety Alert Symbol means: **“ATTENTION! STAY ALERT! YOUR SAFETY IS INVOLVED!”**

The Safety Alert Symbol identifies important safety messages on equipment, safety signs, in manuals or elsewhere. When you see this symbol, be alert to the possibility of death or personal injury. Follow instructions in the safety message.







Reasons Safety is Important:

- Accidents disable and kill.
- Accidents cost.
- Accidents can be avoided.

## Signal Words

Signal words are distinctive words that will typically be found on safety signs on the mower and other worksite equipment. These words may also be found in this manual and the manufacturer's manuals. These words are intended to alert the operator to a hazard and the degree of severity of the hazard.

-  **DANGER** indicates a hazardous situation which, if not avoided, will result in death or serious injury.
-  **WARNING** indicates a hazardous situation which, if not avoided, could result in death or serious injury.
-  **CAUTION** indicates a hazardous situation which, if not avoided, could result in minor or moderate injury.
-  **NOTICE** indicates a property damage message.

## A Word To The User/Operator

It is **YOUR** responsibility to read and understand the safety manual and the manufacturer's manuals before operating this machine. This safety manual takes you step by step through your working day.

**Hazard Recognition and Accident Prevention** depend upon you being alert, careful and properly trained in the operation, transport, maintenance and storage of this equipment.

Graphics have been provided to help you understand the text.

Remember that **YOU** are the key to safety. Good safety practices not only protect you but also protect the people around you. Study and understand this manual and the manufacturer's manuals for your specific machine. Make them a working part of your safety program. Keep in mind that this safety manual is written for industrial/agricultural mowers.

Contact the manufacturer of your equipment to answer any questions about safe operation that remain after studying the manufacturer's operator's manual(s) and this safety manual.

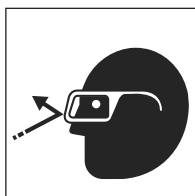
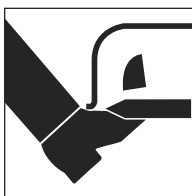

**Practice all other usual and customary safe working precautions and above all:**

**REMEMBER — SAFETY IS UP TO YOU!**

**YOU CAN PREVENT SERIOUS INJURY OR DEATH CAUSED BY UNSAFE WORK PRACTICES!**

# The Industrial/Agricultural Mower

## Industrial/Agricultural Mower Types

Mowers are used for pasture clipping, crop residue shredding, heavy brush cutting, waterways, right-of-ways, roadside or highway mowing. Also, these mowers are used for cutting grass and other growth in public areas such as parks and cemeteries.

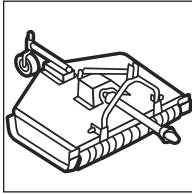

Rotary

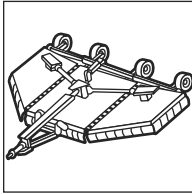

Folding Wing Rotary

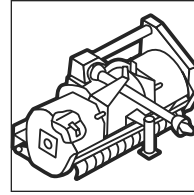

Flail

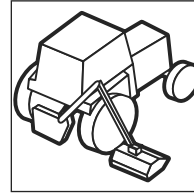

Boom

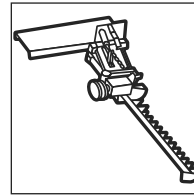

Sickle Bar

# The Industrial/Agricultural Mower

## Agricultural Disc Mower Types

Disc mowers are designed and equipped to cut hay crops at higher field speed.

Disc mower/conditioners mow and condition crops.

Self-propelled windrowers mow and form conditioned hay into windrows.

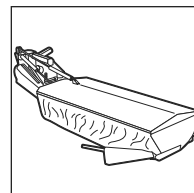

Disc Mower

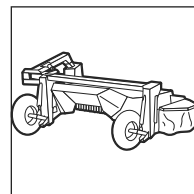

Disc Mower Conditioner

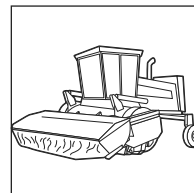

Self-propelled Windrower

# Follow A Safety Program

## Protect Yourself

Wear personal protective clothing and Personal Protective Equipment (PPE) issued to you or called for by job conditions. You must **ALWAYS** wear safety glasses with side shields.

You may also need:

- Hard hat
- Safety shoes
- Safety goggles or face shield
- Heavy gloves
- Hearing protection
- Reflective clothing
- Wet weather gear
- Respirator or filter mask

Wear whatever is needed—don't take chances.

**WARNING!** Prevent death or serious injury from entanglement. **Do not wear loose clothing or accessories. Tie up long hair. Stay away from all rotating components when the engine is running.** Contact, wrapping or entanglement with rotating or moving parts could result in death or serious injury.

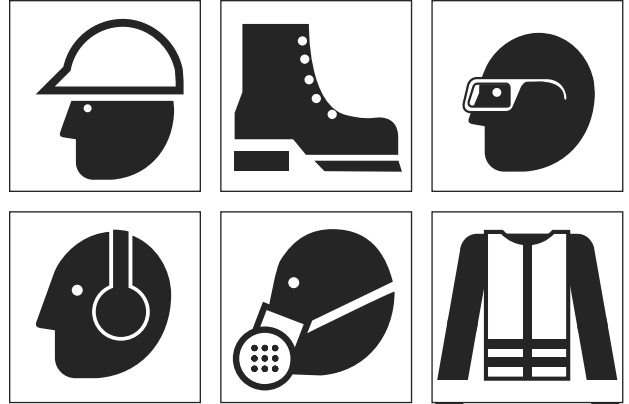

Avoid Entanglement

# Follow A Safety Program

- Read, understand and follow the manufacturer's written instructions found in the operator's manual(s) and safety signs on mower and tractor.
- Have operational training with mower and tractor.
- Take advantage of training programs offered in your area.
- Ask your equipment dealer or supervisor to explain things you do not understand.
- Explain the written instructions in the operator's manual(s) and safety signs to those users or operators who cannot read.
- Inspect the mower and tractor daily before operating. Ensure all guards are in place and the equipment is operating properly.
- Never smoke while operating. Never fill the fuel tank with the engine running or near an open flame.
- Make sure you have adequate visibility and sufficient lighting.
- Know the pinch points and rotating parts. Awareness on your part can prevent accidents.
- Never attempt to operate the controls except from the operator's seat. Improperly controlled functions could produce unexpected machine movement and result in serious injury or death.

- Shut down the mower and tractor before dismounting. (See page 18, **Proper Equipment Shut Down Practices.**)

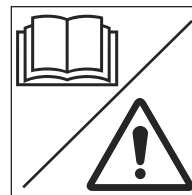

Read, Understand and Follow Manuals and Safety Signs

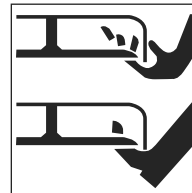

Avoid Rotating Parts

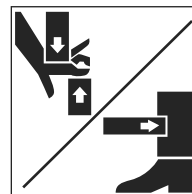

Know and Avoid Pinch Points

# Follow A Safety Program

## Avoid Injury From Raised Equipment

Avoid possible crushing injury from falling mower or other raised equipment.



**Avoid Crushing –  
Block Up or  
Securely Support  
Mower**

Before working near or under raised mower or equipment parts:

- Securely support or block up raised mower or equipment parts according to the operator's manual.
- Securely support, block up or lock up wings with approved locking devices or lower mower or equipment parts to the ground.
- Use transport locks when transporting mower on public roads.

## Avoid Injury From High Pressure Fluid

Avoid fluid injection injury due to high pressure fluid leaks.



**High Pressure  
Fluid Can Inject  
into the Body**

**If any fluid is injected into the skin, it must be removed within a few hours by a doctor familiar with this type of injury.**

Fluid leaks under pressure may not be visible. When checking for leaks or working around pressurized systems:

- Read manufacturer's operator's manual(s) for recommended safety practices.
- Wear a face shield or safety goggles for eye protection.
- Use a piece of cardboard or wood to check for leaks; **DO NOT use your hands.**
- Relieve system pressure before disconnecting lines.
- Check for and repair damaged or leaking lines, pipes and hoses.
- Check for and tighten loose connections.
- Purge air from system before operating.

# Follow A Safety Program

## Avoid Injury From Fire And Explosion

Set the parking brake, shut the mower and tractor engine down and remove the key while filling the fuel tank. Use extra caution when fueling a hot engine. Never smoke while fueling. Avoid sparks by grounding the fuel nozzle against the filler neck.

The fumes in an empty fuel tank are explosive. Never weld or cut on fuel lines, tanks or containers.

Remove all trash or mowing debris from the machine daily or as needed. Keep debris away from engine, exhaust, slip clutches and other heat sources. Use spark arrestors, as appropriate, on the engine exhaust system. Make sure oily rags or other flammable material are not stored on the machine.

Check for fuel, oil or hydraulic fluid leaks. Repair the leaks and clean the machine before you operate it.

Ether/cold start fluid is flammable. Do not smoke when using ether/cold start fluid. Always follow the instructions on the can and in the manufacturer's operator's manual(s) for your mower. Do not use ether/cold start fluid if the engine is equipped with a glow plug or other type of preheater.

Always use a nonflammable solvent when you clean parts. Do not use gasoline, diesel fuel or other flammable fluids.

Store all flammable fluids and materials away from your machine and work area.

Know where fire extinguishers are kept—how they operate—and what type of fire they are for. Check readiness of fire extinguishers according to manufacturer's instructions. Make sure each tractor is equipped with a fire extinguisher.



**No Smoking  
and No Open  
Flames**

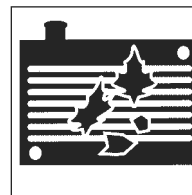

**Remove  
Debris Daily or  
As Needed**

# Follow A Safety Program

## Be Alert!

Know where to get assistance. Know how to use a first aid kit and fire extinguisher/fire suppression system.

## Be Aware!

Take advantage of training programs offered.

## Be Careful!

Human error is caused by many factors: carelessness, fatigue, overload, preoccupation, unfamiliarity of operator with the machine, drugs, and alcohol to name a few. Damage to the tractor or mower can be fixed in a short period of time, but injury, or death, has a lasting effect.

For your safety and the safety of others, encourage your fellow workers to act safely.



## For Safe Operation

You must be a qualified and authorized operator for proper operation of your machine. You must clearly understand the written instructions supplied by the manufacturer, be trained—including actual operation of the mower—and know the safety rules and regulations for the worksite. It is a good safety practice to point out and explain safety signs and practices and ensure others understand the importance of following these instructions.

**WARNING!** Drugs and alcohol affect an operator's alertness and coordination and the operator's ability to safely operate the equipment. **Never use drugs or alcohol while operating the mowing equipment. Never knowingly allow anyone to operate this machine when their alertness or coordination is impaired.** An operator taking prescription or over-the-counter medication must consult a medical professional regarding any side effects of the medication that would hinder their ability to safely operate this equipment.

# Follow A Safety Program

## Know The Rules

Most employers have rules governing operation and maintenance of equipment. Before you start work at a new location, check with your supervisor or the safety coordinator. Ask about the rules you will be expected to obey.

The Occupational Safety and Health Administration (OSHA) enforces federal laws within the United States that apply to safe operation, application and maintenance of equipment on a worksite. It is the employer's responsibility to comply with these laws. An OSHA representative may periodically inspect a worksite to see that these laws are being followed.

There may also be local or state/provincial laws or international regulations that apply to this equipment and its use, along with specific worksite or employer rules. It is important that you know and comply with all applicable laws and rules, including those requiring operator training and certification.



## These are some of the rules you must work by:

- A ROPS and seat belt-equipped tractor is a federal government (OSHA) requirement for operator protection during mowing operations. An enclosed cab provides additional operator protection from thrown objects. Check your mower operator's manual to see if a tractor cab is also required.
- Wear and check that others are wearing proper clothing and personal protective equipment.
- Inspect your machine and attachments before each use as specified by the manufacturer and your employer.
- Know the limitations and operating characteristics of your mowing equipment. Do not misuse it.
- Have all provided shields and guards properly installed before operating the machine.
- Never modify or remove any part of the machine (except for service—then make sure it is replaced).

# Follow A Safety Program

## Some Rules You Must Work By (continued)

- Only qualified and authorized individuals may operate this equipment.
- **Never allow children to play on, ride on or operate** the equipment. Children **are not** qualified to operate this equipment.
- **Do not allow any riders.**
- Use three-point contact (handholds and steps) and face the equipment when mounting or dismounting.
- Keep bystanders 300 ft (92 m) from the mowing operation.
- Know the worksite before you use the mower. Be aware of possible terrain hazards that you may encounter. Remove or mark obstacles and debris that could damage or be thrown by the mower.
- Only use attachments and parts that are approved by the mower manufacturer.
- Make sure all attachments are lowered, set the parking brake, shut off the engine and cycle the control levers. Remove the key before leaving the tractor. (See page 18, **Proper Equipment Shut Down Practices.**)
- When transporting the mower on a trailer, follow the manufacturer's detailed instructions for loading, tying down and unloading the mower.

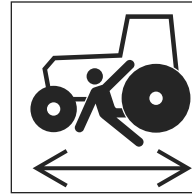

Keep Children Away from Equipment

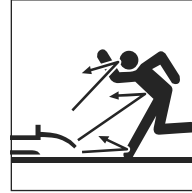

Keep Bystanders Away

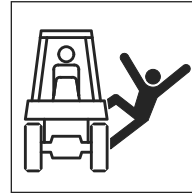

No Riders

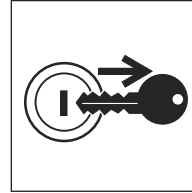

Shut Down Unattended Equipment

# Follow A Safety Program

## Know The Equipment

Read and understand the DANGER, WARNING, CAUTION and NOTICE safety signs and other informational signs on the tractor and mower and in the manufacturer's operator's manual. Ask your supervisor or mower dealer to explain any information you do not understand. Failure to obey safety instructions could result in death or serious injury.

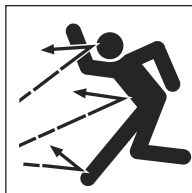

Read and Understand All Safety Signs

Make sure all the manufacturer's protective structures, guards, shields, screens and panels are in good repair, in place and securely fastened. Damaged, missing or weakened safety components can create a hazardous situation for you as the operator. **Never** remove or modify any safety components including thrown object shielding on a mower.

## Know the following about your tractor and mower:

- Function, purpose and use of all controls.
- Correct operation speeds.
- Slope and uneven terrain capabilities and proper operation.
- Braking and steering characteristics.
- Turning radius and clearances.
- How to quickly stop equipment in an emergency.

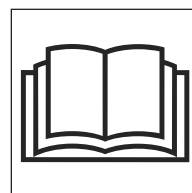

Read and Understand Manuals Before Operating



# Prepare For Safe Operation

## Check The Mower And Tractor Equipment

Before beginning your work day inspect the machine and have all systems in good operational condition.

**WARNING!** Prevent possible crushing injury from falling equipment. Hydraulic system or part failure could cause unsupported equipment to fall. **Do not go under raised equipment unless it is properly supported according to the operator's manual.**

- Perform daily and periodic service procedures as instructed by the equipment manufacturer.
- Check for loose, broken, missing or damaged tractor and mower parts. Repair or replace these parts.
- Check for proper tractor and mower attachments.
- Check for proper tractor and mower PTO rpm rating match.
- Check mower blade(s) condition. Replace severely worn, bent, gouged or nicked blades including the blade bolts and fasteners. Never straighten or weld on blades.
- Ensure thrown object shielding is properly installed and in good condition. Repair or replace if damaged or missing.

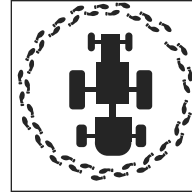

Walk-Around Inspection

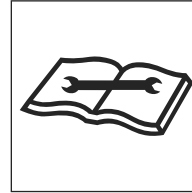

Maintain Machine

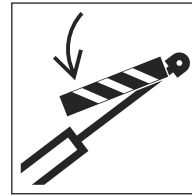

Read Manual – Block Up or Securely Support Mower

# Prepare For Safe Operation

- Check that all guards and shields are in place and that all equipment is in good operating condition. This includes PTO driveline, gearbox and implement guards and shields that are used for operator protection.
- Check for properly latched driveline yoke-end locking devices.
- Check for damaged or leaky tractor and mower hydraulic systems. Repair or adjust as needed.

**WARNING!** Hydraulic fluid under pressure can penetrate the skin or eyes and cause serious injury, blindness or death. Fluid leaks under pressure may not be visible.

**Use a piece of cardboard or wood to find leaks, not your hand. Wear eye protection.** If fluid is injected into the skin, it must be removed within a few hours by medical personnel familiar with this type of injury.

- Keep the operator platform surface clean and free of grease, oil, dirt, snow or ice. Steps and handholds must be clean and functional.
- Ensure work lights are kept clean (if equipped). Check that all lights work properly.
- Ensure the slow moving vehicle (SMV) sign, reflectors and warning lights are in good condition and can be clearly seen.

- Ensure all tools or loose objects are removed or securely fastened while operating the machine.
- Check all safety signs for clarity. Replace damaged signs.



Check for Missing/Damaged Guards and Shields



Check for Leaks and Inspect Hoses

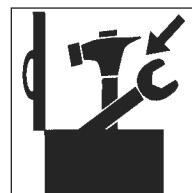

Put Away Tools

# Prepare For Safe Operation

## Know The Work Area

Before you operate the mower thoroughly inspect the work area. Walk around the area and inspect the surfaces you will travel on when using the mower.

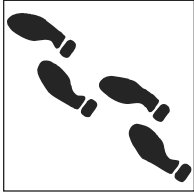

Walk  
Around the  
Worksite

Locate and avoid:

- Holes
- Drop-offs
- Obstacles (stumps)
- Excavations
- Standing water
- Deep mud
- Wet spots
- Soft soil
- Rough spots
- Power lines and apparatus
- Other utilities
- Any conditions which could cause collision, loss of control or tipover
- Steep slopes

Look for debris and obstacles by walking the area before you mow. Objects like wire, cable, rocks, tires, and metal objects that could damage or be thrown by the mower must be removed or marked clearly and avoided.

Correct unsafe conditions. Do not operate in problem areas where debris and obstacles cannot be removed or marked.

Analyze mowing area to determine:

- The most efficient mowing procedure.
- The height of the material to be mowed.
- Operating terrain conditions.
- How to best use forward mowing pattern.
- The potential for bystanders or passers-by to be exposed to thrown objects.

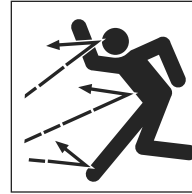

Remove or  
Mark Debris and  
Obstacles

## Look Out For Others

Before starting equipment:

- Walk around the equipment.
- Check for anyone under, on or near the equipment.
- Clear everyone from these areas.
- Sound a warning.

# Prepare For Safe Operation

## Mount And Dismount Tractor Properly

Always use three-point contact when mounting or dismounting the tractor or mower. Face the machine when you enter or leave the machine. Three-point contact means that three out of four arms and legs are in contact with the machine at all times during mount and dismount.

Before mounting:

- Clean shoes and wipe hands. Clean steps and handholds of snow, ice, mud or oil.

During mounting and dismounting:

- Use handholds and step plates.
- Never grab steering wheels or controls for handholds.
- Never mount or dismount from a moving tractor.
- Never mount or dismount while carrying tools or objects that prevent three-point contact. Put parts or tools down. Maintaining proper contact, climb and then pick up the object.



Use  
Three-Point  
Contact



Clean Up  
Slippery Areas

# Prepare For Safe Operation

## Tractor And Mower Controls Safety Test

Start the tractor following the specific procedures in the manufacturer's operator's manual. These procedures normally include:

- Fasten and adjust seat belt on your ROPS-equipped tractor.
- Check parking brake for engagement.
- Check PTO disengagement.
- Check all controls for Park position.
- Warn others in area before starting tractor.
- Start tractor following tractor manufacturer's recommended starting procedures.

**WARNING!** Avoid serious injury or death from unexpected machine movement. **Start the engine only from the operator's position. Never attempt to start the engine by shorting across starter terminals or reaching the key from the ground or outside the cab.**

After starting:

- Check all instruments, gauges and indicator lights for normal operation.
- Check all tractor controls, steering and brakes for proper function.

- Raise and lower mower to check for driveline bottoming out or engagement problems.
- Check the equipment for excessive vibration and unusual noises.

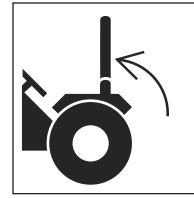
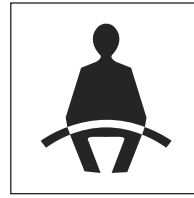

Use ROPS and Seat Belt



Start Only from Operator's Seat

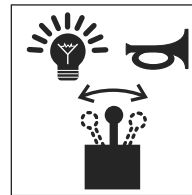

Check Instruments and Controls

# Prepare For Safe Operation

- Use proper equipment shut down practices before inspecting equipment. Wait until all equipment motion has stopped before dismounting the tractor or mower.
- Do not operate mower unless tractor and mower are running properly. Place a "Do Not Operate" tag on the machine, remove the key and do not operate the mower until the problem is corrected.

## Power Takeoff System

Be sure to operate the tractor at the mower's rated PTO rpm speed.

When operating tractors with transmission-driven PTO systems, a rotary mower will have a significant flywheel effect. The mower may continue to propel a tractor with a transmission-driven PTO system.

The tractor should be equipped and operated as follows:

- Install a driveline equipped with an over-running clutch.
- Give yourself sufficient maneuvering room and time by anticipating turns, stops and speed reductions.

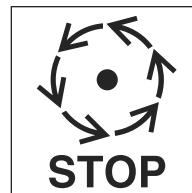

Do Not Dismount Until Equipment Motion Has Stopped

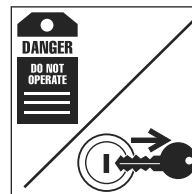

Use a "Do Not Operate" Tag

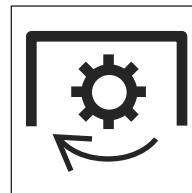

Use Proper PTO Speed

# Prepare For Safe Operation

## Hitching Mower To Tractor

### Three-point hitch-mounted mowers:

- Refer to mower and tractor manufacturers' manuals.
- Place tractor's hydraulic power lift (rockshaft) selector lever in down position to avoid unexpected movement.
- Explain the hitching procedures to those operators who cannot read.
- Front-end weights may be needed to maintain steering control and front-end stability. Refer to the manufacturers' operator's manual(s).
- When backing the tractor up to the mower, NEVER allow anyone between the tractor and the mower.
- Attach the mower to the tractor three-point links and securely pin in position.
- Securely attach the driveline to the tractor PTO. Lower the master shield into place if it is movable. Push and pull on the driveline to ensure it is locked onto the PTO shaft.

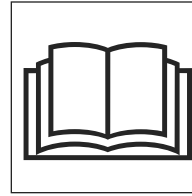

Read and Understand Manuals Before Operating



Maintain Proper Weight Distribution



No One Allowed Between Tractor and Mower



Avoid Entanglement, Use Guards and Shields

# Prepare For Safe Operation

### Pull-type hitch-mounted mowers:

- Refer to mower and tractor manufacturers' manuals.
- Remove three-point hitch quick coupler if equipped.
- Attach only to drawbar hitch.
- Adjust tractor drawbar length for 540 or 1000 rpm PTO operation.
- When backing the tractor up to the mower, NEVER allow anyone between the tractor and the mower.
- Properly attach the mower safety tow chain to the tractor.
- Securely attach the driveline to the tractor PTO. Push and pull on the driveline to ensure it is locked onto the PTO. Lower the master shield into place.
- Hook up the mower hydraulic hoses to the tractor.
- Make sure the wings, or raised mower decks, are supported by the cylinders before removing the transport locks. Never use force to release the transport or wing locks. The wings or deck could fall and crush you.

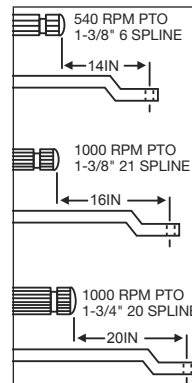

Tractor Drawbar Adjustment

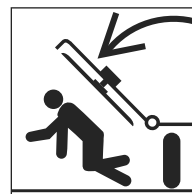

Confirm Wings Are Supported Before Releasing Locks



Avoid Entanglement, Use Guards and Shields

# Start Safely

## Make The Right Start

Mow only in daylight or good artificial light conditions.

Avoid serious injury or death from mower-thrown objects or blade contact:

- Keep chain shields, flexible or solid deflector shields or discharge chutes in place and in good repair.
- Keep bystanders at least 300 ft (92 m) from mowing operation.
- Never direct mower discharge toward anyone.
- Keep hands, feet and other body parts away from rotating parts, blades and discharge openings.
- Do not operate mower in transport position.

Do not approach a mower until all motion has stopped.

Mower PTO drive engagement:

- Raise mower to maximum cutting height.
- Engage PTO at low engine rpm.
- Increase engine rpm to mower's rated rpm PTO speed.
- Lower mower to desired cutting height.
- Stop and shut down immediately if the mower strikes an obstruction.
- Inspect and repair any mower damage before resuming mowing.
- Do not operate mower with severe vibrations or with unusual noise.

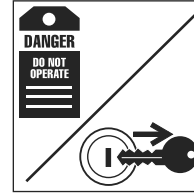
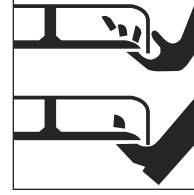

## Mower-Thrown Objects

Depending on the designed purpose, mowers are designed to cut grass, weeds, brush and crops. The mower blades have been designed and tested for rugged use. The mower blades, however, are not intended to contact solid objects like rocks, concrete or metal. Such impact can cause broken objects to be thrown up to 300 ft (92 m). Bystanders should never be within 300 ft (92 m) of an operating rotary mower or within 100 ft (30 M) of a properly equipped disc mower.

# Operate Safely

Mower shielding is designed to reduce the risk of thrown objects and must be properly maintained and in place during mowing operations.

The risk of serious injury or death from thrown objects can be significantly reduced by following three rules.

**If all of these safety rules are not followed, the mowing operation must be stopped if anyone comes within the safety limit for the mower type.**

**First** — Inspect the area prior to mowing and remove stones, branches, wire, cable, metal, glass and other solid objects before operating. Any objects that cannot be removed must be clearly marked and carefully avoided by the operator.

In non-crop areas with grass and weeds high enough to hide objects that could be struck by the blades, inspect the area and remove or mark large debris or obstacles.

Mow the area at an intermediate height. Inspect the area closely and remove or mark any remaining debris or obstacles. Mow again at desired final height.



Follow All Mower Safety Rules

**Second** — Mower-thrown object shielding must be used when operating near roads, parks, populated areas or other areas where thrown objects could injure bystanders or damage property. Follow the manufacturer's operator's manual.

**Third** — Cross diagonally when mowing through ditches, sharp dips, and drops. Raise the mower to prevent the mower blades from hitting the ground.

# Operate Safely

## Mower-Thrown Objects (continued)

**Disc Mowers** — When using a disc mower it is important to know the area to be mowed. If the operator has mowed the field before and is familiar with all obstacles that may be present, it is sufficient to watch ahead of the mower path for any additional objects that may have entered the field. Be ready to stop or avoid any objects that could be hazardous if thrown by the mower. If you plan to mow an unfamiliar field and it is next to a traveled road or people may be within 100 ft (30 m) of the mower you must inspect, and clean or mark the field.

## Mowing In Reverse

Do not mow while traveling in reverse. Objects are more likely to be thrown and can travel further.

Shut off the PTO, wait for the blades to stop turning, raise the mower, and then back up.

Mow traveling in the forward direction.

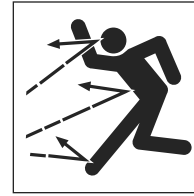

**Do Not Mow  
in Reverse**

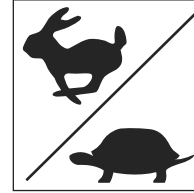

**Use Proper  
Ground Speed**

## Mowing Ground Speed

Proper ground speed depends on terrain conditions and grass type, density and height to be cut:

- Normal ground speed range is 2 to 5 mph.
- Use slower ground speed for mowing tall, dense grass.
- Use faster ground speed for mowing medium height, thin grass and under smooth terrain conditions.
- Use slower ground speed for mowing in rough, sloping or unfamiliar terrain.

Disc mowers are designed to use faster ground speeds for operating in fields clear of debris and surface hazards.

# Operate Safely

## Extremely Tall Grass Mowing

You may need to mow extremely tall, non-crop grass twice. (See page 13, **Mower-Thrown Objects**.)

First mowing pass:

- Shut the mower and tractor down using proper equipment shut down practice before dismounting tractor. (See page 18, **Proper Equipment Shut Down Practices**.)
- Inspect the area and remove or mark debris and obstacles.
- Cut grass higher (10-15 inches) to avoid hidden objects.

Second mowing pass:

- Shut the mower and tractor down using proper equipment shut down practice before dismounting tractor.
- Inspect the area and remove or mark debris and obstacles.
- Cut grass at desired height and, when possible, 90 degrees to the first mowing pass.

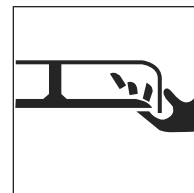

**Stop Blade  
Before  
Unclogging**

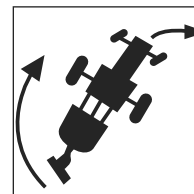

**Provide Adequate  
Clearance for  
Mower Swing**

## Watch Equipment Clearances

Three-point hitch and side-mounted mowers have a larger turning arc than pull-type mowers. Allow sufficient clearance for mower swing while turning.

Do not allow bystanders near the tractor and mower when moving or transporting the tractor and mower.

# Operate Safely

## Under Mount Mower Safety Practices

When mowing with an under mount mower:

- Keep removable discharge chute in place and over discharge opening.
- Never stand on a mower housing when the tractor engine is operating.
- Distribute grass clippings with discharge chute facing mowed area.
- Before clearing a clogged mower or discharge chute, shut down your machine using proper equipment shut down practice. (See page 18, **Proper Equipment Shut Down Practices.**)

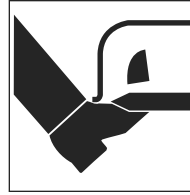

**Never Stand  
on Mower –  
Keep Away**

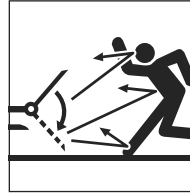

**Keep Chute  
in Place**

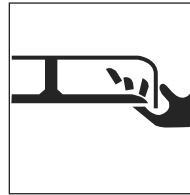

**Stop Blade  
Before  
Unclogging**

# Operate Safely

## Wing Or Boom Mower Overhead Obstruction Hazards And Risks

Check for overhead obstructions with raised wing or boom mowers to avoid serious injury or death by contact with:

- Electrical power lines and apparatus.
- Low tree limbs.
- Other overhead obstructions.
- Maintain specified distance from power lines and apparatus. Never approach energized power lines or apparatus with any part of your machine unless all local, state/provincial and federal (OSHA) required safety precautions have been taken. Use extreme caution.

**DANGER!** Avoid electrocution or serious injury from contact with or inadequate clearance to energized power lines or apparatus. **Do not allow the machine or attachment to approach or contact any power line. Do not approach or touch any machine in contact with a power line.**

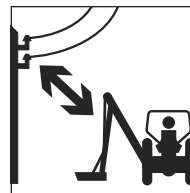

**Do Not  
Approach Energized  
Power Lines**

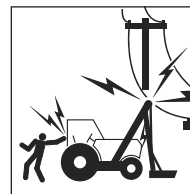

**Stay Clear  
of Energized  
Equipment**

# Operate Safely

## Wing And Side Mount Mowers Safety Practices

Raised wing positions reduce shielding protection and increases the thrown object and blade contact hazard risks.

**Avoid possible serious injury or death by thrown objects or blade contact from raising and lowering wings during mowing operations:**

- Do not mow with bystanders within 300 ft (92 m) of the mower.
- Be sure no one is near mower while raising or lowering wings.
- Shut off the PTO and wait for all rotating elements to stop before raising the mower deck or wing section.
- Only raise wing to clear objects in the mowing path or to match ground slope.
- Lower raised wing to ground after clearing object or ground slope conditions.
- Stop mowing if anyone approaches within 300 ft (92 m) of mowing area.

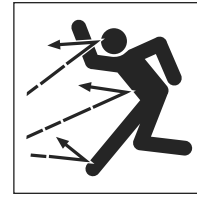
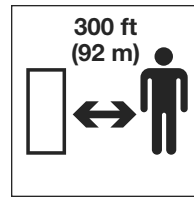

**Keep Bystanders  
Away from  
Mowing Area**

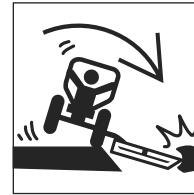

**Avoid Hitting  
Obstructions**

## Ditch Bank Mowing Safety Practices

Use extreme care when mowing ditch banks. Watch for washouts, eroded areas and mowing obstructions along the ditch banks. Hitting obstructions with side-mount or boom mowers may swerve the tractor's front end toward the ditch.

# Operate Safely

Raised wing and boom mower ditch bank operations may reduce the mower's thrown object shielding effectiveness for the mower operator's protection.

- Use enclosed ROPS cabs, special protective enclosures and other operator shielding available from the manufacturer when performing these operations.
- Inspect mowing area and remove or mark all foreign objects and debris to be avoided by mower.

## Uneven Terrain Mowing Safety Practices

Tractor and mower stability is reduced on slopes and uneven terrain.

As in all conditions when mowing, use tractors equipped with ROPS and seat belt. **Make sure the ROPS are raised and locked in place and always wear your seat belt.**

Prevent tractor and mower overturns and maintain equipment stability control:

- Review tractor and mower operator's manuals for operating safety practices on slopes and uneven terrain conditions. Explain the practices to those users and operators who cannot read.
- Avoid extremely steep slope operations.

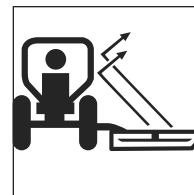

**Use  
Enclosed ROPS  
Cabs or Protective  
Enclosures**

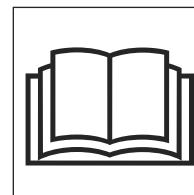

**Read and  
Understand  
Manuals Before  
Operating**

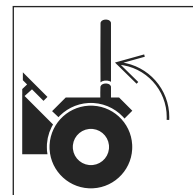
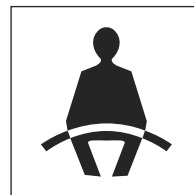

**Use ROPS  
and Seat Belt**



# Operate Safely

## Uneven Terrain Mowing Safety Practices (continued)

- Use extreme care to maintain control over the equipment when operating in these conditions.
- Increase tractor stability by adding wheel weights, ballast and increasing wheel spacing to maximum. Refer to operator's manual for recommendations.
- Maintain minimum ground speed.
- Make wide and gradual turns.
- Avoid sudden starts, stops, and turns when operating up, down, or across slopes.
- **Do not** raise rear-mount or side-mount mowers or mower wings from the ground during these operations.
- Keep alert for holes, bumps, ruts, rocks, stumps or other obstructions that could overturn the machine.
- Avoid slippery ground conditions that could cause loss of control and overturn of tractor and mower.
- Avoid bottoming and striking the ground by diagonal crossing of sharp dips and drops.

Use extreme care in maintaining equipment stability during all uneven terrain and slope mowing operations. You are the final judge as to any slope that can be safely negotiated.

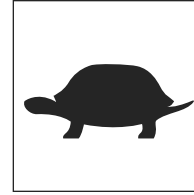

Maintain Control, Use Low Speeds



Add Ballast, Widen Wheel Spacing

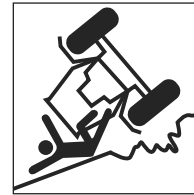

Avoid Ruts, Bumps, Holes

# Operate Safely

## Road Transport Safety Practices

Before operating on public roads:

- Refer to tractor and mower manufacturers' operator's manuals for instructions.
- Explain the instructions to those users or operators who cannot read.
- Check local regulations for required equipment markings, lights, flashers, etc., while traveling on public roads. Lights are required on mowers that obscure tractor taillights and/or warning lights.
- When transporting the mower on a trailer, follow the manufacturer's detailed instructions for loading, tying down and unloading the mower.

Before transporting on public roads:

- Disengage PTO power to mower.
- Raise mower into transport position and engage transport lock.
- Lock mower wings in the transport position with approved locking devices.
- Attach towing safety chain between pull-type mower and tractor.
- Make sure lights, warning lights and reflectors are in place and visible.

- Check SMV (Slow-Moving Vehicle) emblem for visibility to any rear-approaching vehicle.

While transporting on public roads:

- Obey all local traffic regulations.
- Approach intersections with caution.
- Observe speed and traffic control signs.
- Avoid panic stops and sharp turns.

Be a courteous operator and pull over periodically and allow traffic to pass.

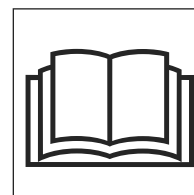

Read and Understand Manuals Before Operating

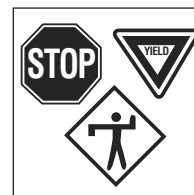

Obey Traffic Regulations

# Park Safely

## Parking Safety Practices

- Use designated or out-of-traffic areas.
- Use firm level ground locations.
- Set parking brake.
- Lower raised equipment to ground.

Shut down the mower and tractor using proper equipment shut down practice before dismounting tractor. (See page 18, **Proper Equipment Shut Down Practices.**)

Sloping ground parking locations:

- Position equipment across slope.
- Set parking brakes.
- Lower raised equipment to ground.
- Block tractor wheels.

Before temporarily parking and leaving disabled equipment near traffic areas:

- Remove equipment from public roads.
- Set out warning flags.
- Use tractor flashing warning lights.

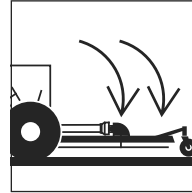

# Shut Down Safely

## Proper Equipment Shut Down Practices

Make proper equipment shut down an important habit.

Properly shutting down a tractor and mower can prevent accidents from occurring when the mower is left unattended. Shut down the mower following the specific procedures in the manufacturer's operator's manual.

These procedures will normally include:

- Reduce engine speed.
- Disengage PTO clutch and transmission drive.
- Idle engine for gradual cooling.
- Place all controls in PARK position.
- Set the parking brake.
- Lower mower to ground.
- Lower wings of wing mowers to ground.
- Shut off engine, lock ignition and remove key from the machine and take it with you.
- Wait for all moving parts to stop before dismounting.
- Relieve hydraulic pressure by moving hydraulic controls several times in all directions.
- Lock anti-vandalism covers and closures, if equipped, when equipment is unattended.
- Dismount carefully maintaining three-point contact.

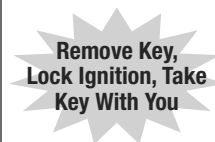
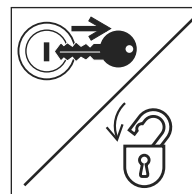
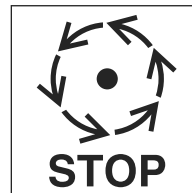
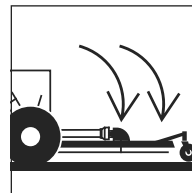
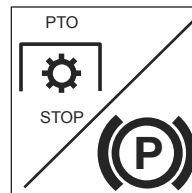

# Shut Down Safely

## Dismounting Properly

- Never dismount from moving equipment.
- Never jump from any machines.
- Dismount carefully.
- Check for slippery steps.
- Keep feet and hands away from controls.
- Use handholds and steps during dismount.
- Face machine and use three-point contact (2 hands and 1 foot or 2 feet and 1 hand).

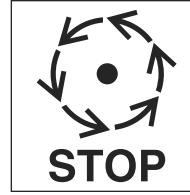

Wait for  
Moving Parts  
to Stop



Use Three-Point  
Contact,  
Face Machine

# Perform Maintenance Safely

## Maintain Your Equipment

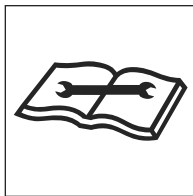

Maintain  
Equipment

Be sure to maintain the equipment according to manufacturer's instructions. Regularly check the operation of the protective and safety devices.

**Do not** perform any work on a tractor or mower unless you are authorized and qualified to do so.

If you have been authorized to do maintenance, **read the operator's and service manuals.** Study the instructions; check the lubrication charts; examine all the instruction messages on the machine. Maintenance can be hazardous unless performed properly. Be sure you have the necessary skill, information, correct tools and equipment to do the job.

**WARNING! Do not modify equipment or add components not approved by the manufacturer.** Use parts, lubricants and service techniques recommended by the manufacturer.

## Mower Parts And Your Safety

Mower manufacturers use specific fasteners and specially designed parts to meet mowing operations requirements. Critical parts (self-locking blade bolts, blades, pins, shields and other special items) have specific strength, design and fit requirements for the make and model mower you are using.

Avoid possible death or serious injury from unapproved parts or modifications:

- Do not substitute common hardware for original manufacturer's blade bolts or other special part items.
- Do not substitute for blades, pins, shields or other critical parts.
- Do not use higher strength bolts to replace original manufacturer's shear bolts.

# Perform Maintenance Safely

## Prepare Yourself

Wear personal protective clothing and Personal Protective Equipment (PPE) issued to you or called for by job conditions. You must **ALWAYS** wear safety glasses with side shields.

You may also need:

- Hard hat
- Safety shoes
- Safety glasses, goggles or face shield
- Apron and gloves
- Hearing protection
- Welding helmet or goggles
- Respirator or filter mask

Wear whatever is needed—don't take chances.

**Keep hands—and clothing—away from all moving parts.** Don't wear dangling ties, loose sleeves, rings, watches, or long hair.

**WARNING!** Prevent death or serious injury from entanglement. **Do not wear loose clothing or accessories. Stay away from all rotating components when the engine is running.** Contact, wrapping or entanglement with rotating or moving parts could result in death or serious injury.



**Avoid Rotating Parts**



**Avoid Pinch Points**

# Perform Maintenance Safely

Wear a rubber apron and rubber gloves when working with corrosives. Wear gloves and safety shoes when handling wooden blocks or sharp-edged metal.

Always use safety glasses, goggles or a face shield. They provide eye protection from fluids under pressure, during grinding and while servicing batteries. Protection is also needed from flying debris, liquids and loose material produced by equipment, tools and pressurized air/water.

Wear a face shield and follow manufacturer's instructions when you disassemble spring-loaded components or work with battery acids. Wear a welding helmet or goggles with a shaded filter when you weld or cut with a torch.

Do not sand, grind, flame-cut, braze or weld without a NIOSH-approved respirator or appropriate ventilation. If welding is required on this machine, refer to the manufacturer's operator's or service manuals or consult your equipment dealer for proper procedures.

Keep pockets free of all objects that could fall out—and drop into machinery.

Handle tools and heavy parts sensibly—with regard for yourself and other persons. Lower items—don't drop them.



**Clean Slippery Surfaces**

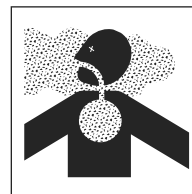

**Ventilate Work Area**

## Prepare The Work Area

- Position the mower in a level area out of the way of other working equipment.
- Make sure there is adequate light, ventilation and clearance.
- Remove oil, grease or water to eliminate any slippery surfaces.
- Clean around the area to be serviced to minimize contamination.

# Perform Maintenance Safely

## Prepare The Machine

Stored energy sources (electrical, mechanical, hydraulic, pneumatic, chemical, thermal, etc.) must be controlled or reduced to a practical minimum before performing any maintenance, repair or service procedures.

### Safety practices to prevent potential injuries from energy-releasing sources:

- Disengage PTO before shutting off engine.
- Place controls in PARK or NEUTRAL before shutting off engine.
- Set parking brake or block wheels.
- Allow all moving parts to stop.
- Lower mower to ground.
- Lower wings to ground on wing mowers.
- Shut off tractor engine.
- Relieve hydraulic system pressure by moving controls several times in all directions.
- Lock ignition, remove key and take it with you.
- Look and listen for evidence of moving parts before dismounting.
- Securely support or block up mower before working underneath mower or other lifted components.

- Securely support, block up, or lock up mower wings with approved locking devices before working near or underneath a wing mower.
- Relieve pressure before disconnecting or disassembling any pressurized system.
- Block or relieve spring pressure before disassembling any spring-loaded mechanism.
- Securely support or block up any raised machine component before working on it.
- Avoid flames, sparks, or smoking near any fuel, hydraulic fluid or other flammable material such as mowing debris.



Prepare  
Machine Systems  
for Service

# Perform Maintenance Safely

Attach a “DO NOT OPERATE” warning tag to the control levers and remove the ignition key if the mower should not be operated. Take the key with you.

Install approved support device(s) when working under or near raised equipment.

**WARNING!** Unsupported raised mowers or other equipment may drop unexpectedly. **Never go under equipment when raised unless supported by an approved support device(s).** Death or serious crushing injury could result from falling equipment.

Remove only guards or covers that provide access to the area being serviced. Replace all guards and covers when work is complete.

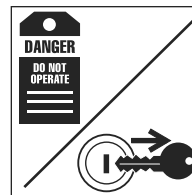

Use a  
“Do Not Operate”  
Tag

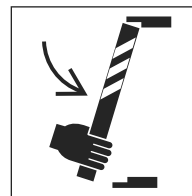

Use  
Approved  
Support Device



Replace  
All Guards

# Perform Maintenance Safely

## Use Proper Ventilation

If it is necessary to run an engine in an enclosed area, remove the exhaust fumes from the area with an exhaust pipe extension. If you do not have an exhaust pipe extension, make sure you open the doors and get outside air into the area.

**WARNING!** Prevent possible injury. **Never work on machinery with the engine running unless instructed by the manufacturer's manuals for specific service.**

**WARNING!** **Never operate any type of engine without proper ventilation—EXHAUST FUMES CAN KILL.**

## Use Jacks And Hoists Carefully

Safety stands or blocks must be located on a rigid part of the mower. Do not position stands under axles or wheel supports that may rotate.

If you must work beneath raised equipment, always use wood—**not concrete**—blocks, jack-stands or other rigid and stable supports. When using jacks or hoists always be sure they are adequately supported.

**WARNING!** Prevent possible crushing injury. **Never use concrete blocks for supports.** They can collapse under even light loads.

Make sure the hoists or jacks you use are in good repair. Never use jacks with cracked, bent, or twisted parts. Never use frayed, twisted or pinched cables. Never use bent or distorted hooks.

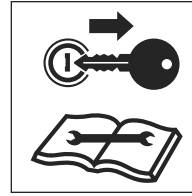

Remove Key and Read Maintenance Manual

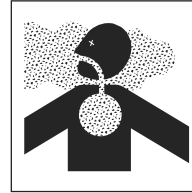

Ventilate Work Area

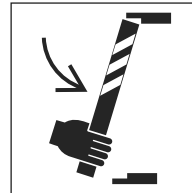

Use Proper Support for Raised Equipment

# Perform Maintenance Safely

## Common Maintenance Safety Practices

### Fuel Hazards

**WARNING!** Always use approved fuel containers and/or dispensing equipment.

Fuels are flammable, so observe these practices to reduce the possibility of a serious accident.

- Shut off engine and ignition during refueling.
- Always ground the fuel nozzle against the filler neck to avoid sparks.
- Keep sparks and open flames away from fuel.
- Do not smoke while refueling or when handling fuel containers.
- Do not cut or weld on or near fuel lines, tanks or containers.
- Do not overfill the tank or spill fuel. Clean up spilled fuel immediately.

### Engine Coolant Hazards

Liquid cooling systems build up pressure as the engine gets hot, so **use extreme caution before** removing the radiator cap.

Be sure to:

- Stop the engine and wait for the system to cool.
- Wear protective clothing and safety glasses.
- Turn the radiator cap slowly to the first stop to allow the pressure to escape before removing the cap completely.



No Smoking and No Open Flames

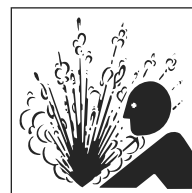

Remove Radiator Cap Slowly

# Perform Maintenance Safely

## Hydraulic System Hazards

The hydraulic system is under pressure whenever the engine is operating and may hold pressure even after the engine is shut off. Cycle all hydraulic controls including the auxiliary hydraulic control after the engine is shut down. Relieve trapped pressure in the lines after the attachments are shut down and resting on the ground.

During inspection of the hydraulic system:

- Wait for fluid to cool before disconnecting the lines. Hot hydraulic fluid can cause SEVERE BURNS.
- **Do not** use your hand to check for leaks. Instead, use a piece of cardboard or paper to search for leaks.
- Wear appropriate eye protection. Hydraulic fluid can cause permanent eye injury.

**WARNING!** Hydraulic fluid under pressure can penetrate the skin or eyes and cause serious injury, blindness or death. Fluid leaks under pressure may not be visible. **Use a piece of cardboard or wood to find leaks, not your hand. Wear a face shield or safety goggles for eye protection.** If fluid is injected into the skin, it must be removed within a few hours by medical personnel familiar with this type of injury.

When venting or filling the hydraulic system, loosen the filler cap slowly and remove it gradually.

**Never** reset any relief valve in the hydraulic system to a pressure higher than recommended by the manufacturer.

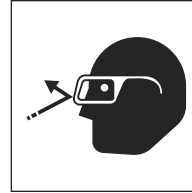

Wear  
Eye Protection



High Pressure  
Fluid Can Inject  
Into the Body

# Perform Maintenance Safely

## Electrical System Hazards

Before working on the electrical system, disconnect the battery cable(s).

- Remove the battery negative (-) cable(s) first.
- When reconnecting the battery, connect the battery negative (-) cable(s) last.

The liquid in batteries contains acid, which is a POISON and can cause SEVERE CHEMICAL BURNS.

## Avoid Injury

- Wear a face shield to prevent contact with your eyes.
- Wear chemical-resistant gloves and clothing to keep electrolyte off your skin and regular clothing.

**WARNING!** Electrolyte will damage eyes or skin on contact. **Always wear a face shield to avoid electrolyte in eyes.** If electrolyte contacts eyes, flush immediately with clean water and get medical attention.

**Wear chemical-resistant gloves and protective clothing to keep electrolyte off skin.** If electrolyte contacts exposed skin or clothing, wash off immediately

with clean water. **If electrolyte is ingested**, seek medical attention immediately. NEVER give fluids that would induce vomiting.

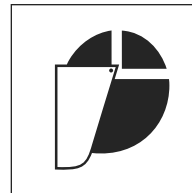

Wear  
Face Protection

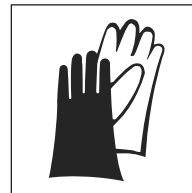

Wear  
Protective  
Clothing

# Perform Maintenance Safely

## Avoid Explosion

**WARNING!** Avoid possible serious injury from explosion. Lead-acid batteries produce extremely explosive gases especially when being charged. **Keep arcs, sparks, flames and lighted tobacco away.**

- Do not smoke near batteries.
- Keep arcs, sparks and open flames away from batteries.
- Provide adequate ventilation.

**Never** check the battery by placing a metal object across the battery posts — the resulting spark could cause an explosion.

**WARNING!** Avoid possible serious injury from battery explosion. **Do not charge a battery or boost start the engine if the battery is frozen.** Warm to 60°F (15.5°C) or the battery may explode and could cause serious injury.

Safety rules during battery boost starting:

- Follow the instructions for proper “battery boost starting” as specified in the manufacturer’s manual.
- Be sure the machines are not touching.

- Observe the polarity of the batteries and connections.
- Make the final cable connection to the engine or the furthest ground point away from the battery. Never make the final connection at the starter or dead battery—sparks may ignite the explosive gases present at the battery.
- When disconnecting cables after jump starting, remove the cables in reverse order of connection (e.g., final connection first).

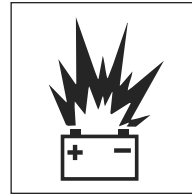

**Avoid Sparks and Open Flames Near Batteries**

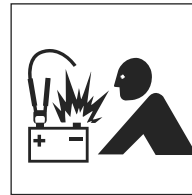

**For Boost Starting Observe Polarity and Make Final Connection at Ground Point**

# Perform Maintenance Safely

## Tire And Wheel Maintenance

Check your tires and wheels daily because the stability of the tractor and mower can be dramatically affected by tire pressure or damage to tires or wheels.

Check tires for:

- Correct pressure.
- Cuts and bulges.
- Nails or other punctures.
- Uneven or excessive wear.
- Condition of valve stems and caps.

Check wheels for:

- Damage to the rims.
- Missing or loose lug nuts or bolts.
- Misalignment.

All tire service should be performed by a qualified tire service center or by an authorized service person who has been properly trained in the procedures and use of safety equipment designed for tire servicing.

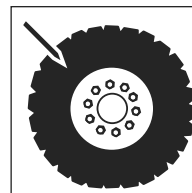

**Check Tires and Wheels for Damage**

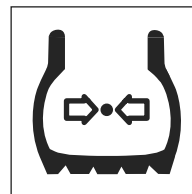

**Maintain Proper Tire Pressure**



# Perform Maintenance Safely

## Tire And Wheel Maintenance (continued)

**WARNING! The types of wheels and tires usually found on this equipment require special care when servicing to prevent death or serious injury.**

Do not inflate the tires above the recommended pressure. Be sure to replace tire ballast if equipped. See manufacturer's specifications for ballast requirements.

Keep wheel lug nuts tightened to manufacturer's recommendations.

A rise in tire pressure during operation is normal, and should NOT be reduced.

Never reinflate a tire that has been run flat or seriously underinflated without removing the tire from the wheel. Have the tire and wheel closely inspected for damage before remounting.

When adding air to a tire, do so from a distance. Use a long hose with self-attaching chuck. Always stand behind tread when adjusting tire pressure.

Do not inflate tires with flammable gases or from systems using an alcohol injector.

Never cut or weld on a wheel with an inflated tire mounted on it. This could cause explosive decompression.

Check that the tire size and wheel are correctly matched.

When replacing the tires, ensure the tires are of the appropriate rating specified by the manufacturer.

Tires should not be operated at speeds higher than their rated speed. Most agricultural tires are rated for 20mph maximum speed.

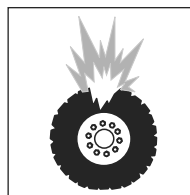

# Perform Maintenance Safely

## Complete Service And Repairs Before Machine Is Released

Tighten all bolts, fittings, and connections to torques specified by the manufacturer.

Install all guards, covers, and shields after servicing. Replace or repair any damaged parts. Refill and recharge pressure systems only with manufacturer approved or recommended fluids.

Start the engine and check for leaks. (See page 23, **Hydraulic System Hazards**.) Operate all controls to make sure the tractor and mower are functioning properly. Test the machine if necessary. After testing, shut down and check the work you performed. Are there any missing cotter pins, washers, locknuts, etc.? Recheck all fluid levels before releasing the equipment for operation.

All parts should be inspected during repair and replaced if worn, cracked or damaged. Excessively worn or damaged parts can fail and cause injury or death.

Replace any damaged or illegible safety signs.



## Mower Blade Maintenance

Do not take chances using damaged or bent blades. The mower manufacturers from the Association of Equipment Manufacturers (AEM) and the Farm Equipment Manufacturers Association (FEMA) advocate that you DO NOT reuse, straighten, hard face or weld mower blades. Death or serious injury could result if a broken blade is thrown from a mower.

# Perform Maintenance Safely

## Mower Blade Maintenance (continued)

### – How are mower blades made?

Mower blades are made of high strength alloy spring steel. They are hot-forged and shaped to meet the manufacturer's individual specifications, then heat treated and tempered to a high strength, ductile state to reduce the possibility of breaking while mowing. Blades are tested to ensure they meet strength, hardness, and ductility standards. If a blade fails to meet any of these specifications, it will not be used on the mower.

### – What happens when a mower blade bends?

It takes a great amount of impact force to bend the blade. This impact force often results in the blades being gouged or chipped. After a blade is damaged by a gouge or chip a blade failure is much more likely to occur. When a blade is severely bent, a microscopic crack may be created in the blade. Straightening the blade does not remove or repair this crack, but may cause additional cracks. Additional stresses during mowing operations can result in an unexpected blade failure.

- **Avoid bending blades.** Help prevent mower blades from bending or cracking by avoiding contact with solid objects. Mower blades are intended to cut grass, shrubs, woody vegetation, and small trees and limbs. They are not intended to contact solid objects such as rocks, concrete, or steel posts. Inspect the area prior to mowing. Remove or clearly mark any solid objects and mow around them.
- **Replace damaged blades!** Inspect the mower blade(s) daily or after hitting any solid object. If a mower blade becomes damaged (bent, gouged, cracked) or worn more than 25 percent of the original size, it should be removed and replaced with a new blade. Always use the original manufacturer's blades. Aftermarket brand blades may not meet the mower manufacturer's strength, hardness and ductility requirements.
- **Do not take chances mowing with damaged or bent blades.** Using a damaged or straightened mower blade can result in the blade breaking and being thrown into the operator or a bystander causing death or serious injury. The price of a new blade is small compared to the potential for the serious injury that could result from a bent or broken blade being thrown from the mower.

## Final Word To The User

You have just finished reading the AEM Industrial and Agricultural Mower Manual. It is impossible for this manual to cover every safety situation that you may encounter on a daily basis. Your knowledge of these safety precautions and your application to the

basic rules of safety will help to build good judgment in all situations. Our objective is to help you develop, establish and maintain good safety habits to make operating an Industrial and Agricultural Mower easier and safer for you.

This manual is another in a series on the safe operation of machinery published by AEM. Many pictorials in this safety manual can be found and downloaded at <http://pictorials.aem.org>. For additional publications visit our website at [www.safetymaterials.org](http://www.safetymaterials.org).



ASSOCIATION OF  
EQUIPMENT MANUFACTURERS

e-mail [safetymaterials@aem.org](mailto:safetymaterials@aem.org)  
[www.aem.org](http://www.aem.org)

CORTADORA  
DE CÉSPED INDUSTRIAL/  
PARA AGRICULTURA

[www.aem.org](http://www.aem.org)



# MANUAL DE SEGURIDAD

PARA EL PERSONAL DE OPERACIONES Y MANTENIMIENTO

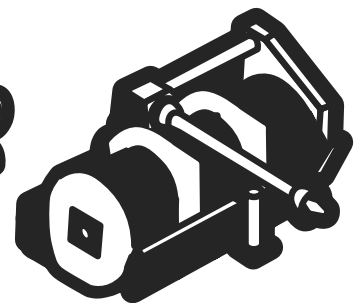
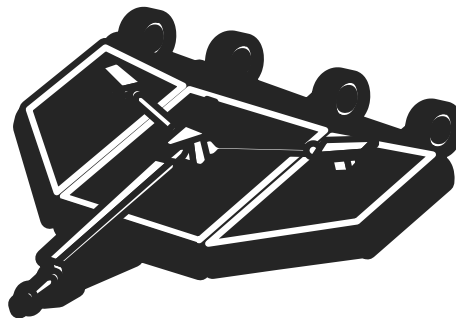
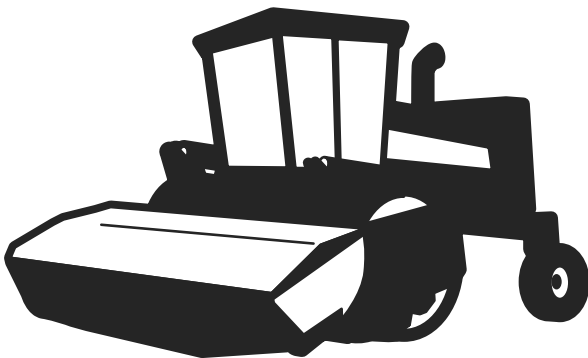
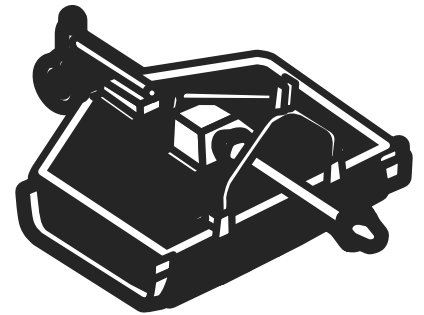
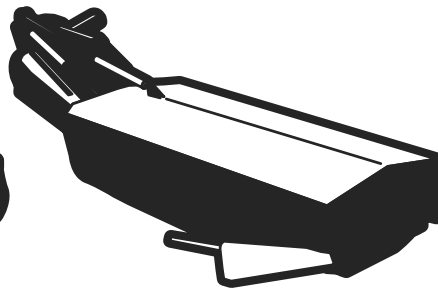
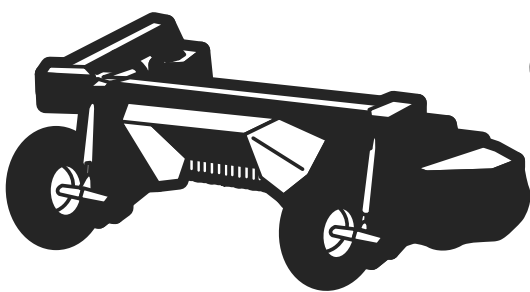

FORMULARIO IAMSE-1009  
Impreso en los EE.UU.

# Contenido

Reconocimiento .....	2
Introducción .....	2
Alertas de seguridad .....	3
Palabras para el usuario/operador .....	3
Cortadora de césped industrial/para agricultura ....	4
Cumplimiento del programa de seguridad .....	5
Preparación para una operación segura .....	9
Arranque con seguridad .....	13
Operación con seguridad .....	13
Estacionamiento seguro .....	18
Apagado con seguridad .....	18
Realización de mantenimiento con seguridad .....	19
Palabras finales para el usuario .....	26

## Reconocimiento

Deseamos reconocer las contribuciones de los miembros del Consejo de Fabricantes de Cortadoras de Césped Industriales/para Agricultura para la preparación de este Manual de seguridad.

### AVISO DE PROTECCIÓN DE COPYRIGHT

Copyright, 2010, por la Asociación de Fabricantes de Equipos (Association of Equipment Manufacturers). Todos los derechos reservados. Queda prohibida la reproducción o difusión parcial o total de este trabajo por cualquier medio sin consentimiento previo por escrito de la Asociación de Fabricantes de Equipos.

Copyright 2010© AEM (Asociación de Fabricantes de Equipos)  
Revisado el 01/03, 09/10

## Introducción

Este manual de seguridad está destinado a señalar algunas de las situaciones de seguridad básicas que pueden surgir durante la operación y el mantenimiento normales de la máquina y a instruirlo en prácticas de seguridad para manejar estas condiciones. Este manual **NO** sustituye los manuales del operador del fabricante de la cortadora de césped.

Puede ser necesario tomar precauciones adicionales o algunas de las instrucciones pueden no ser pertinentes, dependiendo del equipo, los accesorios y las condiciones del sitio de trabajo o del área de servicio. El fabricante no tiene control directo sobre la aplicación, la operación, la inspección o el mantenimiento del equipo. Por lo tanto, es **SU** responsabilidad utilizar prácticas de seguridad correctas en estas áreas.

La información que se proporciona en este manual complementa la información específica sobre la máquina que contienen los manuales del operador del fabricante. Puede haber otra información que afecte la operación segura de la máquina en los letreros de seguridad o en los requisitos del seguro, programas de seguridad y capacitación del empleador, códigos de seguridad, leyes federales, locales, estatales o provinciales, reglas y ordenanzas.

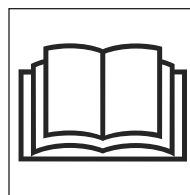

Lea y asegúrese  
de comprender los  
manuales antes  
de comenzar la  
operación



**¡IMPORTANTE!** Antes de hacer funcionar la cortadora de césped, asegúrese de contar con los manuales del operador del fabricante para esta máquina y todos los accesorios. Si faltan los manuales del fabricante, solicite manuales de repuesto a su empleador, al concesionario de los equipos o directamente al fabricante. Guarde este manual de seguridad y los manuales del fabricante con la máquina en todo momento. Lea y asegúrese de comprender todos los manuales.

Se encuentra disponible el video AEM Mower Safety Practices (Prácticas de seguridad para la cortadora de césped de AEM) para capacitar y reforzar prácticas de seguridad correctas. Se alienta a los operadores a ver periódicamente el video de seguridad.

# Alertas de seguridad

## Símbolo

Este símbolo de alerta de seguridad significa: **“¡ATENCIÓN! ¡MANTÉNGASE ALERTA! ¡SU SEGURIDAD ESTÁ EN RIESGO!”**

El símbolo de alerta de seguridad identifica mensajes de seguridad importantes sobre el equipo, sobre letreros de seguridad, en manuales u otros lugares. Cuando vea este símbolo, manténgase alerta ante la posibilidad de muerte o lesiones personales. Siga las instrucciones del mensaje de seguridad.



Motivos por los cuales la seguridad es importante:

- Los accidentes provocan discapacidad y muerte.
- Los accidentes cuestan.
- Los accidentes pueden evitarse.

## Palabras indicativas

Las palabras indicativas son palabras distintivas que típicamente se encontrarán en letreros de seguridad de la cortadora de césped y otros equipos del sitio de trabajo. Estas palabras también se pueden encontrar en este manual y en los manuales del fabricante. Están destinadas a alertar al operador sobre un riesgo y el grado de gravedad del riesgo.



**DANGER (PELIGRO)** indica una situación riesgosa que, si no se evita, resultará en una lesión grave o la muerte.



**WARNING (ADVERTENCIA)** indica una situación riesgosa que, si no se evita, podría resultar en una lesión grave o la muerte.



**CAUTION (PRECAUCIÓN)** indica una situación que, si no se evita, podría resultar en lesiones leves o moderadas.



**NOTICE (AVISO)** indica un mensaje de daños a la propiedad.

# Palabras para el usuario/operador

Es **SU** responsabilidad leer y asegurarse de comprender el manual de seguridad y los manuales del fabricante antes de hacer funcionar esta máquina. Este manual de seguridad lo lleva paso a paso a través de su día de trabajo.

**El reconocimiento de los riesgos y la prevención de accidentes** dependen de que usted esté alerta, sea cuidadoso y se capacite correctamente para la operación, el transporte, el mantenimiento y el almacenamiento de este equipo.

Se han suministrado gráficos útiles para comprender el texto.

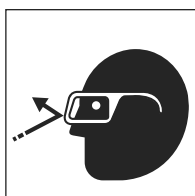

Lea y asegúrese de comprender todos los letreros de seguridad

Recuerde que **USTED** es la clave de la seguridad. Las prácticas de seguridad correctas lo protegen no sólo a usted sino también a las personas que lo rodean. Estudie este manual y los manuales del fabricante para su máquina en particular. Transfórmelos en una parte activa de su programa de seguridad. Tenga presente que este manual de seguridad está escrito para cortadoras de césped industriales/para agricultura.

Contáctese con el fabricante del equipo si le queda alguna pregunta sobre la operación segura después de estudiar los manuales del operador del fabricante y este manual de seguridad.

**Tome todas las demás precauciones habituales y acostumbradas para un trabajo seguro y, sobre todo:**

**RECUERDE:**

**¡LA SEGURIDAD DEPENDE DE USTED!**

**¡PUEDE EVITAR LESIONES GRAVES O MUERTE CAUSADAS POR PRÁCTICAS LABORALES NO SEGURAS!**

# Cortadora de césped industrial/para agricultura

## Tipos de cortadora de césped industrial/para agricultura

Las cortadoras de césped se usan para recortar pasturas, desmenuzar residuos de cultivos, cortar arbustos, realizar desbroce pesado, cortar la hierba en vías de agua, derechos de paso, costados de caminos o autopistas. Además, estas cortadoras se usan para cortar la hierba y otras plantas en zonas públicas como parques y cementerios.

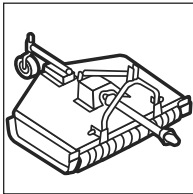

Giratorio

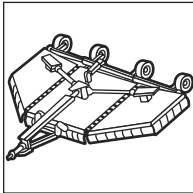

Giratorio con lateral plegable

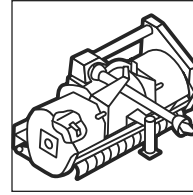

Triturador

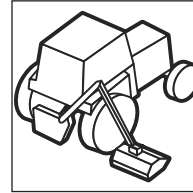

Aguilón

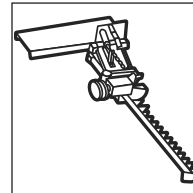

Barra en forma de hoz

# Cortadora de césped industrial/para agricultura

## Tipos de cortadora de césped de disco para agricultura

Las cortadoras de césped de disco están diseñadas y equipadas para cortar cultivos de heno a mayor velocidad de desplazamiento.

Las cortadoras/acondicionadoras de disco cortan y acondicionan los cultivos.

Las formadoras de hileras autopropulsadas cortan el heno y lo acondicionan en hileras.

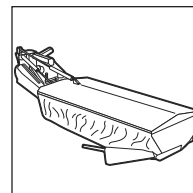

Cortadora de césped de disco

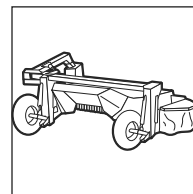

Cortadora/acondicionadora de disco

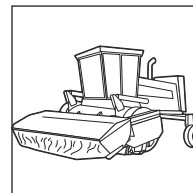

Formadora de hileras autopropulsada

# Cumplimiento del programa de seguridad

## Protéjase a sí mismo

Use la ropa de protección personal y los equipos de protección personal (PPE) que se le proporcionen o que requieran las condiciones del trabajo. **SIEMPRE** debe usar gafas de seguridad con escudos laterales.

Puede necesitar también:

- Casco
- Calzado de seguridad
- Antiparras de seguridad o protección facial
- Guantes gruesos
- Protección para oídos
- Indumentaria reflectiva
- Indumentaria impermeable
- Respirador o máscara con filtro

Use la ropa necesaria; no corra ningún riesgo.

**¡ADVERTENCIA!** Evite lesiones graves o muerte por enredos. **No use ropa floja ni accesorios. Ate el cabello largo. Manténgase alejado de todos los componentes giratorios cuando el motor está en funcionamiento.** El contacto, el enrollado o el enredo con piezas giratorias o móviles podrían resultar en lesiones graves o la muerte.

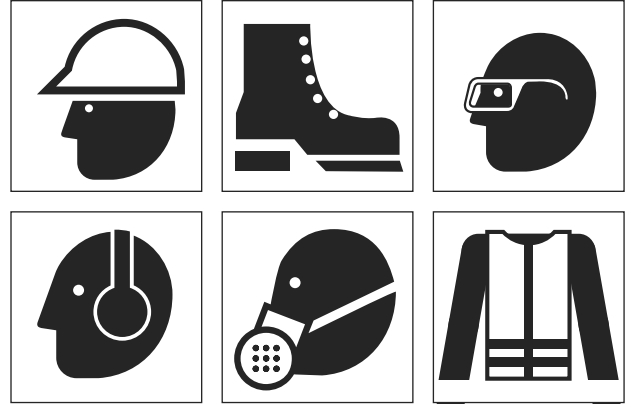

Evite quedar enredado

# Cumplimiento del programa de seguridad

- Lea, asegúrese de comprender y siga las instrucciones escritas del fabricante que se encuentran en el manual del operador y en los letreros de seguridad sobre la cortadora y el tractor.
- Obtenga capacitación para la operación de la cortadora y el tractor.
- Aproveche los programas de capacitación que se ofrecen en su zona.
- Solicítele al distribuidor de equipos o al supervisor que le explique cualquier información que no comprenda.
- Explique las instrucciones escritas de los manuales del operador y los letreros de seguridad a los usuarios u operadores que no puedan leerlas.
- Inspeccione la cortadora y el tractor diariamente antes de hacerlos funcionar. Asegúrese de que todas las guardas se encuentren en su lugar y de que el equipo funcione correctamente.
- Nunca fume mientras lo está manejando. Nunca llene el depósito de combustible con el motor en funcionamiento o cerca de una llama abierta.
- Asegúrese de tener visibilidad adecuada e iluminación suficiente.
- Sepa cuáles son los puntos donde puede quedar atrapado y las partes giratorias. Su conocimiento puede evitar accidentes.
- Nunca intente hacer funcionar los controles, excepto desde el asiento del operador. Las funciones controladas de manera incorrecta pueden producir el movimiento imprevisto de la máquina y resultar en lesiones graves o muerte.
- Apague la cortadora y el tractor antes de descender. (Consulte la página 18, **Prácticas correctas de apagado de los equipos.**)

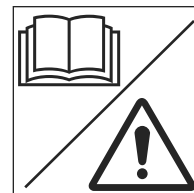

Lea, asegúrese de comprender y siga las indicaciones de los manuales y los letreros de seguridad



Evite las partes giratorias

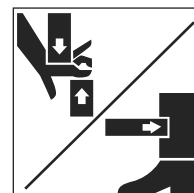

Sepa cuáles son y evite los puntos donde pueda quedar atrapado

# Cumplimiento del programa de seguridad

## Evite las lesiones provocadas por equipos elevados

Evite posibles lesiones de aplastamiento por caídas de la cortadora u otros equipos elevados.



**Evite ser aplastado –  
Bloquee o apoye  
con seguridad la  
cortadora**

Antes de trabajar cerca o debajo de partes levadas de la cortadora o de los equipos:

- Apoye o bloquee con seguridad las partes elevadas de la cortadora o los equipos de acuerdo con el manual del operador.
- Apoye, bloquee o trabe con seguridad los laterales con dispositivos de bloqueo aprobados o descienda las partes de la cortadora o de los equipos hasta el suelo.
- Use trabas de transporte cuando transporte la cortadora por la vía pública.

## Evite lesiones producidas por líquidos a alta presión

Evite las lesiones por inyección de fluidos debidas a fugas de líquidos a alta presión.



**El fluido a alta  
presión puede  
inyectarse en el  
cuerpo**

**Si un fluido se inyecta en la piel, debe ser extraído dentro de pocas horas por personal médico familiarizado con este tipo de lesión.**

Las fugas de fluido bajo presión pueden no ser visibles. Al verificar en busca de fugas o cuando trabaja cerca de sistemas presurizados:

- Lea las prácticas de seguridad recomendadas en los manuales del operador del fabricante.
- Use una protección facial o antiparras de seguridad para proteger los ojos.
- Use un cartón o una madera para buscar fugas; **NO use las manos.**
- Alivie la presión del sistema antes de desconectar líneas.
- Busque y repare las líneas, los tubos y las mangueras dañados o con fugas.
- Busque y apriete las conexiones flojas.
- Purgue el aire del sistema antes de hacerlo funcionar.

# Cumplimiento del programa de seguridad

## Evite lesiones por incendios y explosiones

Aplique el freno de estacionamiento, apague el motor de la cortadora y del tractor y retire la llave mientras llena el depósito de combustible. Tenga precaución adicional cuando carga combustible en un motor caliente. Nunca fume mientras carga combustible. Evite las chispas conectando a tierra la boquilla de combustible contra el cuello de llenado del depósito.

Los vapores de un depósito de combustible vacío son explosivos. Nunca suelde o realice cortes en líneas, depósitos o contenedores de combustible.

Retire toda la basura o los residuos de corte de la máquina todos los días o según sea necesario. Mantenga los residuos alejados del motor, el escape, los embragues y otras fuentes de calor. Use supresores de chispas, según corresponda, en el sistema de escape del motor. Asegúrese de que no haya trapos con aceite u otro material inflamable almacenado en la máquina.

Revise en busca de fugas de combustible, aceite o fluido hidráulico. Repare las fugas y limpie la máquina antes de hacerla funcionar.

El éter/fluido para arranque en frío es inflamable. No fume cuando usa éter/fluido para arranque en frío. Siempre siga las instrucciones del recipiente y de los manuales del

operador del fabricante correspondientes a la cortadora de césped. No use éter/fluido para arranque en frío si el motor está equipado con bujías de precalentamiento u otro dispositivo de precalentamiento.

Siempre use solvente no inflamable para limpiar las partes. No use gasolina, combustible diesel u otros fluidos inflamables. Almacene todos los fluidos y materiales inflamables lejos de la máquina y de la zona de trabajo.

Sepa dónde se guardan los extintores de incendios, cómo funcionan y para qué tipo de incendio están destinados. Verifique la disponibilidad de los extintores de incendios de acuerdo con las instrucciones del fabricante. Asegúrese de que cada tractor esté equipado con un extintor de incendios.



**No fumar;  
evitar las llamas  
abiertas**

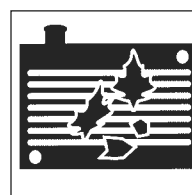

**Retire los  
residuos a diario  
o según sea  
necesario**



# Cumplimiento del programa de seguridad

## ¡Manténgase alerta!

Sepa dónde obtener asistencia. Sepa cómo usar un equipo de primeros auxilios y un extintor de incendios/ sistema de supresión de fuego.

## ¡Manténgase informado!

Aproveche los programas de capacitación que se ofrecen.

## ¡Tenga cuidado!

El error humano es causado por muchos factores: descuido, fatiga, sobrecarga, preocupación, desconocimiento de la máquina por parte del operador, fármacos y alcohol, entre muchos otros. Los daños al tractor o la cortadora de césped se pueden arreglar en un tiempo breve, pero las lesiones o la muerte tienen un efecto perdurable.

Por su seguridad y la de los demás, aliente a sus compañeros de trabajo a actuar con seguridad.

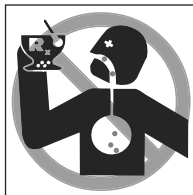
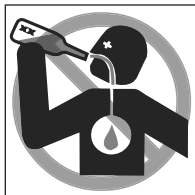

**Nunca use fármacos o alcohol mientras está operando la máquina**

## Para una operación segura

Usted debe ser un operador cualificado y autorizado para operar la máquina correctamente. Debe comprender claramente las instrucciones por escrito que proporciona el fabricante, recibir capacitación (que incluya la operación real de la cortadora de césped) y conocer las reglas y ordenanzas de seguridad correspondientes al sitio de trabajo. Una buena práctica de seguridad consiste en señalar y explicar los letreros y las prácticas de seguridad y asegurarse de que otras personas comprendan la importancia de seguir estas instrucciones.

**¡ADVERTENCIA!** Los fármacos y el alcohol afectan la capacidad de alerta y de coordinación del operador, así como su capacidad para operar los equipos con seguridad. **Nunca use fármacos o alcohol mientras opera el equipo de la cortadora. Nunca permita a sabiendas que otra persona opere esta máquina con la capacidad de alerta o coordinación deteriorada.**

Un operador que toma un medicamento recetado o de venta libre debe consultar a un profesional médico con respecto a los efectos colaterales del medicamento que podrían reducir su capacidad de operar este equipo con seguridad.

# Cumplimiento del programa de seguridad

## Conozca las reglas

La mayoría de los empleadores tienen reglas que rigen la operación y el mantenimiento de los equipos. Antes de comenzar a trabajar en una ubicación nueva, verifique con el supervisor o con el coordinador de seguridad. Averigüe sobre las reglas que tendrá que obedecer.

La Administración de Seguridad y Salud Ocupacional (Occupational Safety and Health Administration, OSHA) hace cumplir leyes federales dentro de los EE.UU. que se aplican a la operación, la aplicación y el mantenimiento seguros de equipos en un sitio de trabajo. Es responsabilidad del empleador cumplir estas leyes. Un representante de OSHA puede visitar periódicamente un sitio de trabajo para ver si estas leyes se cumplen.

También puede haber leyes estatales/provinciales o locales u ordenanzas internacionales que se apliquen a este equipo y a su uso, junto con reglas específicas del sitio de trabajo o del empleador. Es importante que conozca y cumpla todas las leyes y reglas aplicables, incluso las que requieren capacitación y certificación del operador.

## Las siguientes son algunas de las reglas que debe cumplir al trabajar:

- Un ROPS (sistema de protección antivuelco) y un tractor equipado con cinturón de seguridad es exigencia del

gobierno federal (OSHA) para la protección de los operadores durante el funcionamiento de la cortadora. Una cabina cerrada proporciona protección adicional para el operador con respecto a objetos arrojados. Verifique el manual del operador de la cortadora de césped para ver si también se requiere una cabina de tractor.

- Use y verifique que otras personas usen la indumentaria y los equipos de protección personal correctos.
- Inspeccione la máquina y los accesorios antes de cada uso según lo especificado por el fabricante y por su empleador.
- Conozca las limitaciones y las características operativas del equipo de corte de césped. No haga un uso indebido.
- Verifique que todos los escudos y las guardas estén correctamente instalados antes de hacer funcionar la máquina.
- Nunca modifique o retire partes de la máquina (excepto para realizar servicios; después, asegúrese de que se vuelvan a colocar en su lugar).

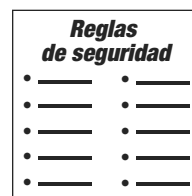

**Sepa cuáles son y asegúrese de comprender las reglas de funcionamiento**

# Cumplimiento del programa de seguridad

## Algunas reglas que debe cumplir al trabajar (continuación)

- Únicamente personas cualificadas y autorizadas pueden manejar estos equipos.
- **Nunca permita que los niños jueguen** en los equipos, **viajen** en ellos o los hagan **funcionar**. Los niños **no están** cualificados para manejar estos equipos.
- **No** transporte pasajeros.
- Use contacto en tres puntos (asideros y peldaños) y enfrente el equipo al ascender o descender de él.
- Mantenga a las personas ajenas a 300 pies (92 m) de la operación de corte.
- Familiarícese con el sitio de trabajo antes de usar la cortadora de césped. Tenga en cuenta posibles riesgos que puede encontrar en el terreno. Retire o marque los obstáculos y residuos que podrían dañar la cortadora o ser arrojados por ella.
- Utilice sólo accesorios y partes aprobados por el fabricante de la cortadora de césped.
- Asegúrese de que todos accesorios estén descendidos, aplique el freno de estacionamiento, apague el motor y haga funcionar todas las palancas de control. Retire la llave antes de salir del tractor. (Consulte la página 18, **Prácticas correctas de apagado de los equipos.**)
- Cuando transporte la cortadora de césped en un remolque, siga las instrucciones detalladas del fabricante para la carga, el amarre y la descarga de la cortadora.

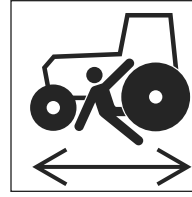

Mantenga a los niños alejados de los equipos

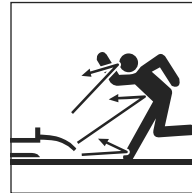

Mantenga a las personas ajenas alejadas

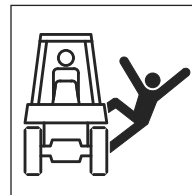

No lleve pasajeros

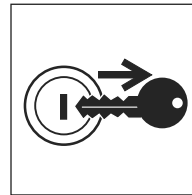

Apague los equipos cuando están sin vigilancia

# Cumplimiento del programa de seguridad

## Conozca los equipos

Lea y asegúrese de comprender los letreros de seguridad que indican PELIGRO, ADVERTENCIA, PRECAUCIÓN y AVISO y otros letreros informativos que hay sobre el tractor y la cortadora de césped y en el manual del operador del fabricante. Solicítele al supervisor o al distribuidor de la cortadora que le explique cualquier información que no comprenda. El incumplimiento de las instrucciones de seguridad podría resultar en lesiones graves o muerte.

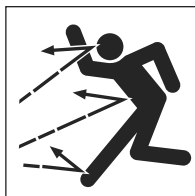

Lea y asegúrese de comprender todos los letreros de seguridad

Asegúrese de que todas las estructuras de protección, guardas, escudos, pantallas y paneles del fabricante están bien reparados, en su lugar y bien ajustados. Los componentes de seguridad dañados, faltantes o debilitados pueden crear una situación de riesgo para usted como operador. **Nunca** retire o modifique ningún componente de seguridad (incluso escudos para objetos arrojados) que haya en la cortadora.

## Conozca lo siguiente sobre el tractor y la cortadora de césped:

- Funcionamiento, propósito y uso de todos los controles.
- Velocidades de funcionamiento correctas.
- Capacidades y funcionamiento correcto en pendientes y terrenos desparejos.
- Características del frenado y la dirección.
- Radio de giro y separaciones.
- Cómo detener los equipos rápidamente en una emergencia.

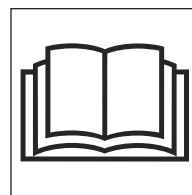

Lea y asegúrese de comprender los manuales antes de comenzar la operación

# Preparación para una operación segura

## Revise los equipos de la cortadora de césped y el tractor

Antes de comenzar la jornada de trabajo, inspeccione la máquina y asegúrese de que todos los sistemas estén en buenas condiciones operacionales.

**¡ADVERTENCIA!** Evite posibles lesiones por aplastamiento producidas por equipos que caen. La falla del sistema hidráulico o de una parte podría causar la caída de equipos que no están apoyados. **No permanezca debajo de equipos elevados excepto que estén correctamente apoyados de acuerdo con el manual del operador.**

- Realice procedimientos de servicio diarios y periódicos según lo indicado por el fabricante del equipo.
- Verifique para detectar piezas faltantes, dañadas, rotas o flojas en el tractor y en la cortadora de césped. Repare o sustituya esas piezas.
- Verifique que los accesorios del tractor y la cortadora sean los correctos.
- Verifique que la clasificación nominal de velocidad de TDF del tractor y la cortadora sea la correcta.
- Verifique el estado de las hojas de la cortadora de césped. Sustituya las hojas que se encuentren gravemente gastadas, dobladas, agujereadas o

marcadas; incluya los pernos y sujetadores de las hojas. Nunca enderece o suelde en las hojas.

- Asegúrese de que el escudo para objetos que son arrojados se encuentre correctamente instalado y en buen estado. Repárelo o sustitúyalo si está dañado o falta.

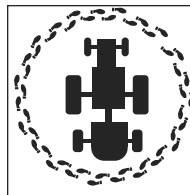

Recorrida de inspección

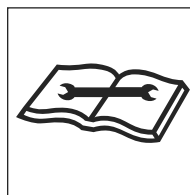

Realice el mantenimiento de la máquina

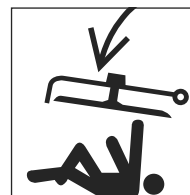
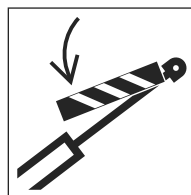

Lea el manual – Bloquee o apoye con seguridad la cortadora

# Preparación para una operación segura

- Verifique que todos los escudos y guardas estén en su lugar y que todos los equipos se encuentren en buenas condiciones de funcionamiento. Esto incluye la línea motriz de la TDF, la caja de engranajes y las guardas y escudos de los implementos que se usan para proteger al operador.
- Verifique que los dispositivos de bloqueo del extremo en horquilla de la línea motriz estén correctamente enclavados.
- Verifique en busca de sistemas hidráulicos dañados o con fugas en el tractor o la cortadora. Repare o ajuste según sea necesario.

**¡ADVERTENCIA!** El fluido hidráulico bajo presión puede penetrar la piel o los ojos y causar lesiones graves, ceguera o la muerte. Las fugas de fluido bajo presión pueden no ser visibles. **Utilice un cartón o una madera para buscar fugas, no la mano. Use protección ocular.** Si el fluido se inyecta en la piel, debe ser extraído dentro de las próximas pocas horas por personal médico familiarizado con este tipo de lesión.

- Mantenga la superficie de la plataforma del operador limpia y libre de grasa, aceite, suciedad, nieve o hielo. Los peldaños y asideros deben estar limpios y funcionar correctamente.
- Asegúrese de que las luces de trabajo se mantengan limpias (si están instaladas). Verifique que todas las luces funcionen correctamente.

- Asegúrese de que el letrero de vehículo de movimiento lento, los y las luces de advertencia estén en buenas condiciones y puedan verse claramente.
- Asegúrese de que todas las herramientas y objetos sueltos se retiren o se sujeten con seguridad mientras se opera la máquina.
- Verifique que todos los letreros de seguridad se vean con claridad. Sustituya los letreros dañados.



Revise para detectar/guardas y escudos dañados



Verifique en busca de fugas e inspeccione las mangueras

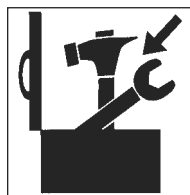

Aparte las reflectores herramientas

# Preparación para una operación segura

## Familiarícese con la zona de trabajo

Antes de hacer funcionar la cortadora de césped, inspeccione cuidadosamente la zona de trabajo. Recorra a pie alrededor de la zona e inspeccione las superficies sobre las cuales se desplazará cuando utilice la cortadora.

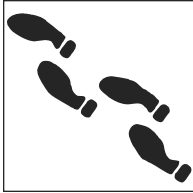

Recorra a pie alrededor del lugar de trabajo

Localice y evite:

- Agujeros
- Desmoronamientos
- Obstáculos (tocones)
- Excavaciones
- Agua estancada
- Lodo profundo
- Puntos mojados
- Suelo blando
- Puntos irregulares
- Líneas y aparatos eléctricos
- Otros servicios públicos
- Cualquier condición que podría causar una colisión, pérdida de control o vuelco
- Pendientes empinadas

Busque residuos y obstáculos recorriendo a pie la zona antes de cortar. Los objetos como alambre, cable, rocas, neumáticos y metales que podrían dañar o ser arrojados por la cortadora de césped deben retirarse o marcarse claramente y evitarse.

Corrija las condiciones no seguras. No opere en áreas con problemas donde no se puedan retirar o marcar los residuos y los obstáculos.

Analice la zona de corte para determinar:

- El procedimiento de corte más eficiente.
- La altura del material que debe cortarse.
- Las condiciones operativas del terreno.
- Cómo usar mejor el patrón de corte en sentido de avance.
- Las posibilidades de que personas ajenas o que pasan circunstancialmente queden expuestas a objetos que se arrojan.

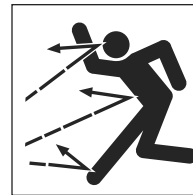

Retire o marque los residuos y obstáculos

## Tenga cuidado con otras personas

Antes de poner en marcha los equipos:

- Recorra a pie alrededor de los equipos.
- Verifique en busca de personas debajo o cerca de los equipos.
- Retire a todas las personas de esas zonas.
- Haga sonar una advertencia.

# Preparación para una operación segura

## Ascienda y descienda del tractor correctamente

Siempre use contacto de tres puntos al ascender o descender del tractor o de la cortadora de césped. Enfrente la máquina al ingresar o salir de ella. Un contacto de tres puntos significa que tres de los cuatro miembros (brazos y piernas) están en contacto con la máquina en todo momento durante el ascenso y descenso.

Antes de ascender:

- Límpiense el calzado y las manos. Limpie la nieve, el hielo, el lodo o el aceite de los peldaños y asideros.

Durante el ascenso y el descenso:

- Use los asideros y los estribos.
- Nunca se aferre al volante o a los controles como asideros.
- Nunca ascienda o descienda de un tractor en movimiento.
- Nunca ascienda o descienda transportando herramientas u objetos que impidan el contacto de tres puntos. Deje en el piso las piezas o las herramientas. Manteniendo el contacto correcto, suba y, después, recoja el objeto.



Utilice contacto de tres puntos



Limpie las superficies resbaladizas

# Preparación para una operación segura

## Prueba de seguridad de los controles del tractor y de la cortadora de césped

Arranque el tractor siguiendo los procedimientos específicos del manual del operador del fabricante. Estos procedimientos normalmente incluyen:

- Colóquese y ajústese el cinturón de seguridad en el tractor equipado con ROPS.
- Verifique que el freno de estacionamiento esté aplicado.
- Verifique que la TDF esté desenganchada.
- Verifique que todos los controles estén en la posición de estacionamiento.
- Advierta a otras personas en la zona antes de arrancar el tractor.
- Arranque el tractor siguiendo los procedimientos de arranque que recomienda el fabricante del tractor.

**¡ADVERTENCIA!** Evite lesiones graves o muertes producidas por el movimiento inesperado de la máquina. **Arranque el motor únicamente desde el puesto del operador. Nunca intente arrancar el motor haciendo un corto entre los bornes del arranque o tomando la llave desde el suelo o desde afuera de la cabina.**

Después del arranque:

- Verifique que todos los instrumentos, indicadores y luces indicadoras funcionen normalmente.
- Verifique que todos los controles, la dirección y los frenos del tractor funcionen correctamente.

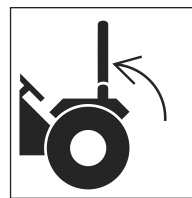
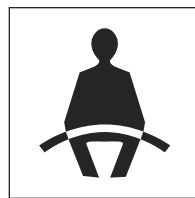

Use el ROPS y el cinturón de seguridad

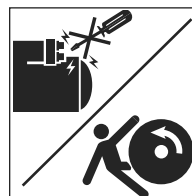

Arranque únicamente desde el asiento del operador

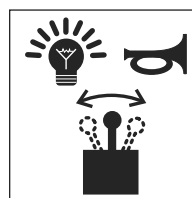

Revise los instrumentos y controles

- Eleve y descienda la cortadora de césped en busca de problemas en el descenso total o el enganche de la línea motriz.
- Verifique los equipos en busca de vibraciones excesivas y ruidos anormales.

# Preparación para una operación segura

- Use las prácticas correctas de apagado de los equipos antes de inspeccionar equipos. Espere hasta que todo movimiento de los equipos se haya detenido antes de descender del tractor o la cortadora de césped.
- No haga funcionar la cortadora si el tractor y la cortadora de césped no funcionan correctamente. Coloque una etiqueta que indique “No poner en funcionamiento” en la máquina, retire la llave y no haga funcionar la cortadora hasta que el problema se haya corregido.

## Sistema de toma de fuerza (TDF)

Asegúrese de hacer funcionar el tractor a la velocidad de TDF indicada para la cortadora.

Al hacer funcionar tractores con sistemas de TDF impulsados por transmisión, una cortadora giratoria tiene un significativo efecto de rueda volante. La cortadora puede seguir propulsando un tractor con un sistema de TDF impulsado por transmisión.

El tractor debe estar equipado y funcionar como sigue:

- Instale una línea motriz equipada con un embrague de sobrecarga.
- Prevea suficiente espacio y tiempo para maniobrar anticipando los giros, las paradas y las reducciones de velocidad.



No descienda hasta que el movimiento de los equipos se haya detenido



Use una etiqueta que indique “No poner en funcionamiento”

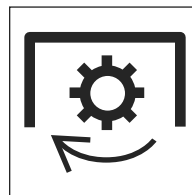

Use la velocidad de la TDF

# Preparación para una operación segura

## Enganche de la cortadora de césped al tractor

### Cortadoras montadas en enganche de tres puntos:

- Consulte los manuales de los fabricantes de la cortadora y del tractor.
- Coloque la palanca selectora de elevación de potencia hidráulica del tractor en la posición descendida para evitar movimientos imprevistos.
- Explique los procedimientos de enganche a los operadores que no puedan leerlos.
- Pueden requerirse pesos en el extremo delantero para mantener el control de la dirección y la estabilidad del extremo delantero. Consulte los manuales del operador de los fabricantes.
- Al hacer retroceder el tractor hasta la cortadora de césped, NUNCA permita que haya personas entre tractor y la cortadora.
- Instale la cortadora en los eslabones de tres puntos del tractor y asegúrela en su lugar con pasadores.
- Instale con seguridad la línea motriz a la TDF del tractor. Descienda el escudo principal hasta su lugar si es móvil. Empuje y tire de la línea motriz para asegurarse de que esté trabada en el vástago de la TDF.

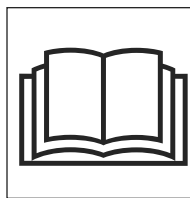

Lea y asegúrese de comprender los manuales antes de comenzar la operación



Mantenga una distribución correcta del peso



No permita que haya nadie entre el tractor y la cortadora de césped



Evite quedar enredado, use guardas y escudos

# Preparación para una operación segura

### Cortadoras montadas en enganche tipo de tiro:

- Consulte los manuales de los fabricantes de la cortadora y del tractor.
- Retire el acople rápido del enganche de tres puntos si está instalado.
- Instálelo únicamente al enganche de la barra de tiro.
- Ajuste la longitud de la barra de tiro del tractor para el funcionamiento de la TDF a 540 ó 1000 rpm.
- Al hacer retroceder el tractor hasta la cortadora de césped, NUNCA permita que haya personas entre tractor y la cortadora.
- Instale correctamente la cadena de remolque de seguridad de la cortadora en el tractor.
- Instale con seguridad la línea motriz a la TDF del tractor. Empuje y tire de la línea motriz para asegurarse de que esté trabada en la TDF. Descienda el escudo principal a su lugar.
- Conecte las mangueras hidráulicas de la cortadora de césped en el tractor.
- Asegúrese de que los laterales o las plataformas elevadas de la cortadora estén sostenidas por los cilindros antes de retirar las trabas de transporte. Nunca haga fuerza para soltar las trabas de transporte o de los laterales. Los laterales o la plataforma podrían caerse y aplastarlo.

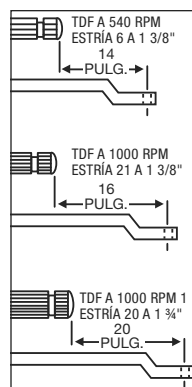

Ajuste de la barra de tiro del tractor



Confirme que los laterales estén apoyados antes de soltar las trabas



Evite quedar enredado, use guardas y escudos

# Arranque con seguridad

## Cómo realizar un arranque correcto

Corte la hierba únicamente con luz diurna o en condiciones de buena luz artificial.

Evite lesiones graves o muerte producidas por objetos arrojados por la cortadora o por el contacto con las hojas:

- Mantenga los escudos de las cadenas, los escudos deflectores flexibles o sólidos y las rampas de descarga en su lugar y en buen estado de reparación.
- Mantenga a las personas ajenas a 300 pies (92 m) de la operación de corte.
- Nunca dirija la descarga de la cortadora hacia una persona.
- Mantenga las manos, los pies y otras partes del cuerpo alejadas de las piezas giratorias, las hojas y las aberturas de descarga.
- No haga funcionar la cortadora de césped en la posición de transporte.

No se acerque a una cortadora hasta que todo movimiento se haya detenido.

Enganche de la transmisión de RDF de la cortadora de césped:

- Eleve la cortadora hasta la altura de corte máxima.
- Enganche la TDF a baja velocidad del motor.
- Aumente la velocidad del motor hasta llegar a la velocidad nominal de la TDF.
- Descienda la cortadora hasta la altura de corte deseada.
- Detenga y apague de inmediato si la cortadora golpea contra una obstrucción.
- Inspeccione y repare cualquier daño de la cortadora antes de reanudar el corte.
- No haga funcionar una cortadora que vibra en exceso o produce ruidos anormales.

## Operación con seguridad

Los escudos de la cortadora están diseñados para reducir el riesgo de objetos arrojados y se deben mantener correctamente y en su lugar durante las operaciones de corte.

El riesgo de lesiones graves o muerte puede reducirse significativamente si se siguen estas reglas. **Si no se siguen todas estas reglas de seguridad, la operación de corte debe detenerse en caso de que alguna persona ingrese dentro del límite de seguridad correspondiente a cada tipo de cortadora.**

**Primero** — Inspeccione la zona antes de cortar y retire las piedras, ramas, alambres, cables, metales, vidrios y otros objetos sólidos antes de hacer funcionar la máquina. Los objetos que no puedan retirarse deben marcarse con claridad y ser evitados con cuidado por el operador.

En áreas sin cultivos con hierba y maleza de altura suficiente como para ocultar objetos que podrían ser golpeados por las hojas, inspeccione la zona y retire o marque los residuos u obstáculos grandes.

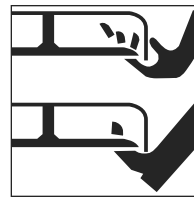

**Hojas giratorias – Manténgase**



**No ponga en funcionamiento una cortadora de césped dañada**

## Objetos arrojados por la cortadora de césped

Dependiendo del propósito previsto, las cortadoras están diseñadas para cortar hierba, maleza, broza y cultivos. Las hojas de la cortadora están diseñadas y probadas para uso intensivo. Las hojas de la cortadora, sin embargo, no están diseñadas para entrar en contacto con objetos sólidos como rocas, cemento o metales. Un impacto de este tipo puede arrojar objetos rotos hasta 300 pies (92 m) de distancia. Nunca debe haber personas ajenas a menos de 300 pies (92 m) de una cortadora giratoria en funcionamiento o a menos de 100 pies (30 m) de una cortadora de disco correctamente equipada.



**Siga todas las reglas de seguridad**

Realice el corte de la zona a una altura intermedia. Inspeccione la zona atentamente y retire o marque cualquier residuo u obstáculo restante. Corte nuevamente a la altura final deseada.

**Segundo** — Los escudos para objetos arrojados por la cortadora deben usarse cuando se opera cerca de caminos, parques, zonas pobladas u otras zonas donde objetos arrojados podrían lesionar a personas ajenas o dañar la propiedad. Siga el manual del operador del fabricante.

**Tercero** — Cruce en sentido diagonal cuando realiza el corte a través de zanjas, depresiones marcadas y hundimientos. Eleve la cortadora para evitar que las hojas de la cortadora golpeen el suelo.

# Operación con seguridad

## Objetos arrojados por la cortadora de césped (continuación)

**Cortadoras de disco** — Cuando se usa una cortadora de disco, es importante conocer la zona donde se va a cortar. Si el operador ha realizado cortes en el terreno antes y está familiarizado con todos los obstáculos que puede haber, es suficiente observar delante de la trayectoria de la cortadora para detectar cualquier objeto adicional que pueda haber ingresado en el terreno. Está preparado para detenerse o evitar objetos que podrían ser peligrosos si son arrojados por la cortadora. Si piensa cortar en un terreno que no conoce bien y se encuentra junto a un camino transitado o puede haber personas a menos de 100 pies (30 m) de la cortadora de césped, debe inspeccionar y limpiar o marcar el terreno.

## Cómo cortar en retroceso

No corte mientras se desplaza en retroceso. Es más probable que se arrojen objetos y que éstos puedan llegar más lejos.



No corte en retroceso

Apague la TDF, espere que las hojas dejen de girar, eleve la cortadora y, después, retroceda.

Corte desplazándose en sentido de avance.

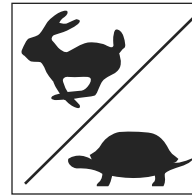

Use la velocidad de desplazamiento correcta

## Velocidad de desplazamiento durante el corte

La velocidad de desplazamiento correcta depende de las condiciones del terreno y del tipo de hierba, la densidad y la altura que debe cortarse:

- El rango normal de velocidad de desplazamiento es de 2 a 5 mph (3.2 a 8 km/h).
- Use una velocidad de desplazamiento menor para cortar hierbas altas y densas.
- Use una velocidad de desplazamiento mayor para cortar hierba delgada a altura media y con condiciones de terreno sin dificultades.
- Use una velocidad de desplazamiento menor para acortar en terreno irregular, con pendientes o no muy conocido.

Las cortadoras de disco están diseñadas para usar velocidades de desplazamiento mayores cuando funcionan en terrenos despejados de residuos y peligros superficiales.

# Operación con seguridad

## Corte de hierba extremadamente alta

Puede ser necesario cortar dos veces la hierba extremadamente alta que no sea cultivo. (Consulte la página 13, **Objetos arrojados por la cortadora de césped.**)

Primera pasada de corte:

- Apague la cortadora y el tractor usando la práctica correcta de apagado de equipos antes de descender del tractor. (Consulte la página 18, **Prácticas correctas de apagado de los equipos.**)
- Inspeccione la zona y retire o marque cualquier residuo u obstáculo.
- Corte la hierba a mayor altura (10 a 15 pulg. [25 a 38 cm]) para evitar los objetos ocultos.

Segunda pasada de corte:

- Apague la cortadora y el tractor usando la práctica correcta de apagado de equipos antes de descender del tractor.
- Inspeccione la zona y retire o marque cualquier residuo u obstáculo.
- Corte la hierba a la altura deseada y, de ser posible, a 90 grados con respecto a la primera pasada de corte.

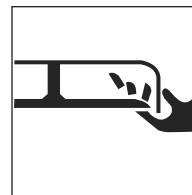

Detenga la hoja antes de desatascar

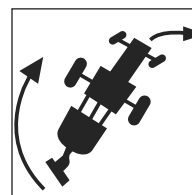

Proporcione el espacio libre adecuado para la oscilación de la cortadora de césped

## Preste atención a los espacios libres de los equipos

Las cortadoras con enganche de tres puntos y montaje lateral tienen un arco de giro mayor que las tipo de tiro. Deje el espacio libre suficiente para la oscilación de la cortadora cuando gira.

No permita que haya personas ajenas cerca del tractor y la cortadora de césped cuando mueve o transporta el tractor y la cortadora.



# Operación con seguridad

## Prácticas de seguridad para la cortadora de césped de montaje inferior

Cuando se traslada con una cortadora de césped de montaje inferior:

- Mantenga la rampa de descarga extraíble en su lugar y por encima de la abertura de descarga.
- Nunca se pare sobre la carcasa de una cortadora de césped cuando el motor del tractor está en funcionamiento.
- Distribuya los recortes de hierba con la rampa de descarga orientada hacia la zona donde se cortó.
- Antes de limpiar una cortadora o una rampa de descarga atascada, apague la máquina usando la práctica correcta para apagado del equipo. (Consulte la página 18, **Prácticas correctas de apagado de los equipos.**)

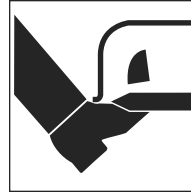

**Nunca se pare sobre la cortadora de césped – Manténgase alejado**

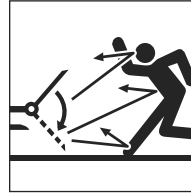

**Mantenga la rampa en su lugar**

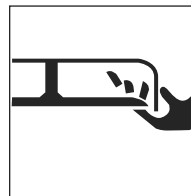

**Detenga la hoja antes de desatascar**

# Operación con seguridad

## Cortadora de césped con lateral o aguilón Peligros y riesgos de obstrucciones elevadas

Verifique en busca de obstrucciones elevadas con las cortadoras que tienen el lateral o el aguilón elevado, para evitar lesiones graves o la muerte por contacto con:

- Líneas y aparatos eléctricos.
- Ramas bajas de los árboles.
- Otras obstrucciones elevadas.
- Mantenga las distancias especificadas con respecto a los cables y los aparatos eléctricos. Nunca se acerque a cables o aparatos eléctricos energizados con ninguna parte de la máquina, salvo que se hayan tomado todas las precauciones de seguridad locales, estatales/provinciales y federales (OSHA) necesarias. Use extrema precaución.

**¡PELIGRO!** Evite la electrocución o lesiones graves por contacto o un espacio libre inadecuado con respecto a líneas o aparatos eléctricos energizados. **No permita que la máquina o el accesorio se acerque o entre en contacto con una línea de electricidad. No se acerque ni toque una máquina que esté en contacto con una línea de electricidad.**

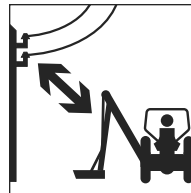

**No se acerque a líneas de electricidad energizadas**

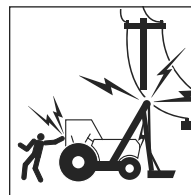

**Manténgase alejado de los equipos energizados**

# Operación con seguridad

## Prácticas de seguridad para cortadoras de césped con laterales y montaje lateral

Las posiciones elevadas de los laterales reducen la protección de los escudos y aumentan los riesgos de objetos arrojados y contacto con las hojas.

### Evite la posibilidad de lesiones graves o muerte por objetos arrojados o contacto con las hojas causados por la elevación y el descenso de los laterales durante las operaciones de corte:

- No realice cortes con personas ajenas presentes a menos de 300 pies (92 m) de la cortadora de césped.
- Asegúrese de que no haya personas cerca de la cortadora mientras se elevan o descienden los laterales.
- Apague la TDF y espere hasta que todos los elementos giratorios se hayan detenido antes de elevar la plataforma o la sección lateral de la cortadora.
- Únicamente eleve el lateral para quitar objetos de la trayectoria de corte o para acompañar una pendiente del terreno.
- Descienda hasta el suelo el lateral elevado una vez que se eliminó el objeto o se superó la pendiente.
- Detenga el trabajo de corte si alguna persona se acerca a menos de 300 pies (92 m) de la zona de corte.

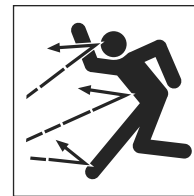
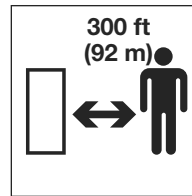

Mantenga a las personas ajenas alejadas de la zona de corte

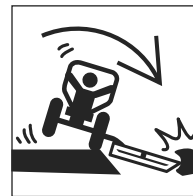

Evite golpear obstrucciones

## Prácticas de seguridad para trabajos de corte en orillas de zanjas

Use extremo cuidado al realizar cortes en orillas de zanjas. Preste atención a escurrimientos, zonas erosionadas y obstrucciones para el corte a lo largo de las orillas de zanjas. Si se golpean obstrucciones con cortadoras de montaje lateral o con aguilón, el extremo delantero del tractor puede desviarse hacia la zanja.

# Operación con seguridad

Los trabajos en orillas de zanjas con aguilón y lateral elevado pueden reducir la eficacia de la protección del operador de la cortadora que proporcionan los escudos para objetos arrojados.

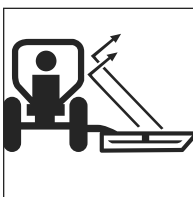

Utilice cabinas cerradas con ROPS o cerramientos de protección

- Cuando realice estas operaciones, use cabinas cerradas con ROPS, cerramientos protectores especiales y otros escudos para el operador que ofrece el fabricante.
- Inspeccione la zona de corte y retire o marque todos los objetos extraños y los residuos que deberá esquivar la cortadora.

## Prácticas de seguridad para trabajos de corte en terrenos desparejos

Las pendientes y los terrenos desparejos reducen la estabilidad del tractor y de la cortadora.

Como en todas las condiciones de corte, use tractores equipados con ROPS y cinturón de seguridad. **Asegúrese**

### de que el ROPS está elevado y trabado en su lugar y use siempre el cinturón de seguridad.

Prevenga los vuelcos del tractor y de la cortadora de césped y mantenga controlada la estabilidad de los equipos:

- Repase los manuales del operador del tractor y de la cortadora para ver las prácticas de seguridad para operaciones en pendientes y terrenos desparejos. Explique las prácticas a los operadores que no puedan leerlas.
- Evite trabajar en pendientes extremadamente empinadas.

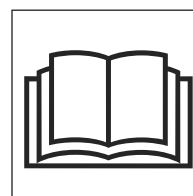

Lea y asegúrese de comprender los manuales antes de comenzar la operación

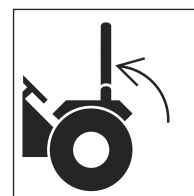
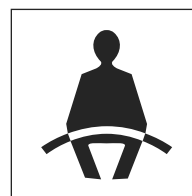

Use el ROPS y el cinturón de seguridad

# Operación con seguridad

## Prácticas de seguridad para trabajos de corte en terrenos desparejos (continuación)

- Use extremo cuidado para mantener el control de los equipos cuando trabaja en estas condiciones.
- Aumente la estabilidad del tractor agregando pesos o lastre en las ruedas y aumentando al máximo la separación entre las ruedas. Consulte las recomendaciones en el manual del operador.
- Mantenga la velocidad de desplazamiento en el mínimo.
- Realice giros amplios y graduales.
- Evite los arranques, las paradas y los giros bruscos cuando trabaje en subidas o bajadas de pendientes o sobre ellas.
- **No** levante del suelo las cortadoras de montaje trasero o de montaje lateral ni los laterales de la cortadora durante estas operaciones.
- Manténganse alerta en busca de agujeros, baches, pozos, tocones u otras obstrucciones que podrían hacer volcar la máquina.
- Evite las condiciones de suelo resbaladizo que podrían causar la pérdida de control y el vuelco del tractor y la cortadora.
- Evite bajar completamente y golpear el suelo cuando cruza en sentido diagonal depresiones marcadas y hundimientos.

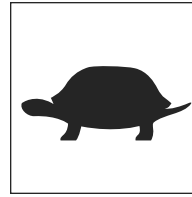

Mantenga el control, desplácese

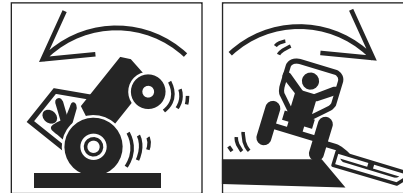

Agregue lastre, ensanche la separación entre las ruedas

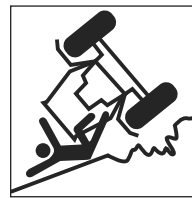

Evite los pozos, baches y agujeros

Use extremo cuidado al mantener la estabilidad de los equipos durante todos los trabajos de corte en terrenos desparejos y pendientes. Usted es quien juzga en última instancia si en cualquier pendiente se puede trabajar con seguridad.

# Operación con seguridad

## Prácticas de seguridad para el transporte en caminos

Antes de operar en la vía pública:

- Consulte los manuales del operador de los fabricantes de la cortadora y del tractor para ver instrucciones.
- Explique las instrucciones a los usuarios u operadores que no puedan leerlas.
- Verifique las ordenanzas locales sobre marcas, luces, balizas, etc. requeridas en los equipos durante el desplazamiento por la vía pública. Se requieren luces en las cortadoras que obstaculizan la visibilidad de las luces traseras y/o las luces de advertencia del tractor.
- Cuando transporte la cortadora de césped en un remolque, siga las instrucciones detalladas del fabricante para la carga, el amarre y la descarga de la cortadora.

Antes de transportar en la vía pública:

- Desconecte la alimentación de la TDF a la cortadora.
- Eleve la cortadora a la posición de transporte y aplique la traba para transporte.
- Trabe los laterales de la cortadora de césped en la posición de transporte con dispositivos de bloqueo aprobados.
- Instale una cadena de seguridad para remolque entre la cortadora tipo de tiro y el tractor.
- Asegúrese de que las luces, las luces de advertencia y los reflectores están en su lugar y son visibles.

- Verifique que el emblema de vehículo de movimiento le resulte visible a cualquier vehículo que se aproxime por atrás.

Durante el transporte en la vía pública:

- Obedezca todas las ordenanzas de tránsito locales.
- Acérquese a las intersecciones con precaución.
- Observe los letreros de velocidad y control del tránsito.
- Evite las paradas de emergencia y los giros cerrados.

Sea un operador amable y apártese periódicamente para dejar pasar el tránsito.

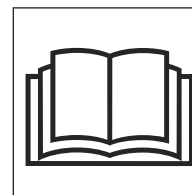

Lea y asegúrese de comprender los manuales antes de comenzar la operación

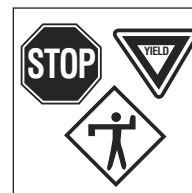

Obedezca las ordenanzas de tránsito

# Estacionamiento seguro

## Prácticas de seguridad para el estacionamiento

- Use las zonas designadas o alejadas del tránsito.
- Use lugares con suelo firme y nivelado.
- Aplique el freno de estacionamiento.
- Descienda el equipo de la cortadora de césped hasta el suelo.

Apague la cortadora y el tractor usando la práctica correcta de apagado de equipos antes de descender del tractor. (Consulte la página 18, **Prácticas correctas de apagado de los equipos.**)

Lugares de estacionamiento con suelo en pendiente:

- Ubique los equipos transversalmente con respecto a la pendiente.
- Aplique los frenos de estacionamiento.
- Descienda el equipo de la cortadora de césped hasta el suelo.
- Bloquee las ruedas del tractor.



**Aplique el freno de estacionamiento**

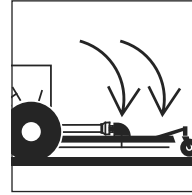

**Descienda los equipos elevados hasta el suelo**

Antes de estacionar temporalmente y dejar equipos deshabilitados cerca de zonas con tránsito:

- Retire los equipos de la vía pública.
- Instale banderas de advertencia.
- Use las balizas de advertencia del tractor.

# Apagado con seguridad

## Prácticas correctas de apagado de los equipos

Transforme el apagado correcto de los equipos en un hábito.

El apagado correcto de un tractor y una cortadora de césped puede ayudar a evitar accidentes cuando la cortadora está sin vigilancia. Apague la cortadora siguiendo los procedimientos específicos del manual del operador del fabricante. Estos procedimientos normalmente incluirán:

- Reduzca la velocidad del motor.
- Desenganche el embrague de la TDF y la transmisión.
- Haga funcionar el motor en ralentí para que se enfríe gradualmente.
- Coloque todos los controles en la posición de estacionamiento.
- Aplique el freno de estacionamiento.
- Descienda la cortadora de césped hasta el suelo.
- Descienda los laterales de las cortadoras con laterales hasta el suelo.
- Apague el motor, trabe la ignición y retire la llave de la máquina; llévela con usted.
- Espere hasta que todas las piezas móviles se hayan detenido antes de descender.
- Libere la presión hidráulica moviendo los controles hidráulicos varias veces en todas las direcciones.
- Trabe las cubiertas y los cerramientos antivandalismo, si están instalados, cuando los equipos están sin vigilancia.
- Descienda con cuidado manteniendo contacto de tres puntos.

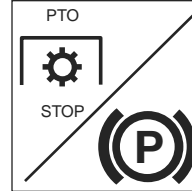

**Desenganche la TDF, aplique el freno**

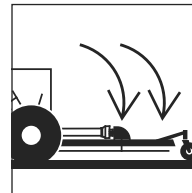

**Descienda los equipos elevados hasta el suelo**



**Espere hasta que las piezas giratorias se detengan**

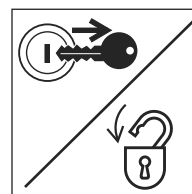

**Retire la llave, trabe la ignición, llévese la llave**

# Apagado con seguridad

## Descenso correcto

- Nunca descienda de equipos en movimiento.
- Nunca baje de una máquina saltando.
- Descienda con cuidado.
- Verifique que no haya peldaños resbaladizos.
- Mantenga los pies y las manos lejos de los controles.
- Use los asideros y los peldaños durante el descenso.
- Enfrente la máquina y use contacto de tres puntos (2 manos y 1 pie o 2 pies y 1 mano).



Espere hasta que las piezas móviles se detengan



Use contacto de tres puntos; enfrente a la máquina

# Realización de mantenimiento con seguridad

## Mantenimiento de los equipos

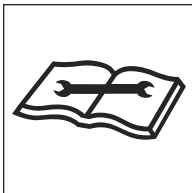

Realice el mantenimiento de los equipos

Asegúrese de mantener los equipos de acuerdo con las instrucciones del fabricante. Verifique con regularidad el funcionamiento de los dispositivos de protección y de seguridad.

**No** realice ningún trabajo en un tractor o en una cortadora de césped si no está autorizado y cualificado para hacerlo.

Si ha sido autorizado para realizar mantenimiento, **lea los manuales del operador y de servicios**. Estudie las instrucciones; verifique las tablas de lubricación; examine todos los mensajes de instrucciones que haya sobre la máquina. El mantenimiento puede ser peligroso si no se realiza correctamente. Asegúrese de tener las habilidades necesarias, la información y las herramientas y equipos correctos para realizar el trabajo.

**¡ADVERTENCIA!** No modifique equipos ni agregue componentes no aprobados por el fabricante. Use piezas, lubricantes y técnicas de servicio recomendadas por el fabricante.

## Piezas de la cortadora de césped y seguridad personal

Los fabricantes de cortadoras de césped usan sujetadores y específicos y piezas especialmente diseñadas para cumplir con los requisitos de las operaciones de las cortadoras. Las piezas críticas (pernos autobloqueantes de las hojas, hojas, pasadores, escudos y otros componentes especiales) tienen requisitos específicos de resistencia, diseño y ajuste para la marca y el modelo de cortadora que usted está usando.

Evite posibles lesiones graves o la muerte por el uso de piezas o modificaciones no aprobadas:

- No sustituya con tornillería común los pernos de las hojas u otros componentes de piezas especiales originales del fabricante.
- No sustituya hojas, pasadores, escudos u otras piezas críticas.
- No use pernos de mayor resistencia para reemplazar los pernos de seguridad originales del fabricante.

# Realización de mantenimiento con seguridad

## Preparación personal

Use la ropa de protección personal y los equipos de protección personal (PPE) que se le proporcionen o que requieran las condiciones del trabajo. **SIEMPRE** debe usar gafas de seguridad con escudos laterales.

Puede necesitar también:

- Casco
- Calzado de seguridad
- Anteojos de seguridad, antiparras o protección facial
- Delantal y guantes
- Protección para oídos
- Casco o antiparras para soldar
- Respirador o máscara con filtro

Use la ropa necesaria; no corra ningún riesgo.

**Mantenga las manos (y la ropa) alejadas de todas las piezas móviles.** No use cordones sueltos, mangas flojas, anillos, relojes o cabello largo.

**¡ADVERTENCIA!** Evite lesiones graves o muerte por enredos. **No use ropa floja ni accesorios. Manténgase alejado de todos los componentes giratorios cuando el motor está en funcionamiento.** El contacto, el enrollado o el enredo con piezas giratorias o móviles podrían resultar en lesiones graves o la muerte.

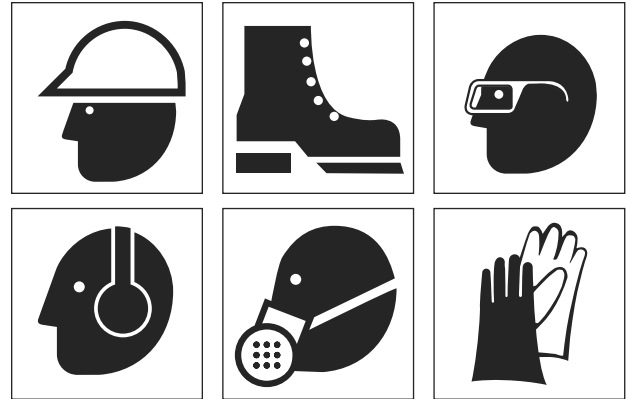

Evite las piezas giratorias



Evite puntos donde pueda quedar atrapado

# Realización de mantenimiento con seguridad

Use un delantal de caucho y guantes de caucho cuando trabaja con sustancias corrosivas. Use guantes y calzado de seguridad cuando manipula bloques de madera o metales con bordes agudos.

Use siempre anteojos de seguridad, antiparras o protección facial. Proporcionan protección ocular para fluidos bajo presión, mientras se esmerila y se realizan servicios a las baterías. También es necesaria protección contra residuos, líquidos y material suelto producido por el equipo, las herramientas y el aire/agua presurizada.

Use protección facial y siga las instrucciones del fabricante cuando desarma componentes cargados a resorte o cuando trabaja con ácidos de batería. Use un casco o antiparras para soldar con filtro esfumado cuando suelda o corta con soplete.

No arene, esmerile, corte con soplete o suelde sin un respirador aprobado por NIOSH o una ventilación adecuada. Si se requiere soldar en esta máquina, consulte los manuales del operador o de servicios del fabricante o consulte al concesionario de los equipos para obtener los procedimientos correctos.

Mantenga los bolsillos sin objetos que podrían salirse y caer dentro de la maquinaria.



Limpie las superficies resbaladizas

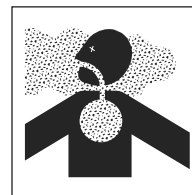

Ventile la zona de trabajo

Maneje las herramientas y las piezas pesadas con sensatez con respecto a usted mismo y a otras personas. Deposite los elementos, no los deje caer.

## Preparación de la zona de trabajo

- Ubique la cortadora de césped en una zona nivelada fuera del paso de otros equipos en funcionamiento.
- Asegúrese de que haya luz, ventilación y espacio libre adecuados.
- Quite el aceite, la grasa o el agua para eliminar toda superficie resbaladiza.
- Limpie alrededor de la zona donde se realizarán servicios para minimizar la contaminación.

# Realización de mantenimiento con seguridad

## Preparación de la máquina

Deben controlarse o reducirse las fuentes de energía almacenada (eléctricas, mecánicas, hidráulicas, neumáticas, químicas, térmicas, etc.) al mínimo practicable antes de realizar cualquier procedimiento de mantenimiento, reparación o servicio.

### Prácticas de seguridad para prevenir posibles lesiones por fuentes que liberan energía:

- Desenganche la TDF antes de apagar el motor.
- Coloque los controles en la posición de estacionamiento o punto muerto antes de apagar el motor.
- Aplique el freno de estacionamiento o bloquee las ruedas.
- Espere hasta que todas las piezas móviles se detengan.
- Descienda la cortadora de césped hasta el suelo.
- Descienda los laterales de las cortadoras con laterales hasta el suelo.
- Apague el motor del tractor.
- Libere la presión del sistema hidráulico moviendo los controles varias veces en todas las direcciones.
- Trabe la ignición, retire la llave y llévesela.



Prepare los sistemas de la máquina para realizarles servicios

- Escuche y observe en busca de evidencias que indiquen piezas en movimiento antes de descender.
- Apoye o bloquee con seguridad la cortadora de césped antes de trabajar debajo de ella o de otros componentes elevados.
- Apoye, bloquee o trabe con seguridad los laterales de la cortadora con dispositivos de traba aprobados antes de trabajar cerca o debajo de una cortadora con laterales.
- Alivie la presión antes de desconectar o desarmar un sistema presurizado.
- Bloquee o alivie la presión de los resortes antes de desarmar un mecanismo cargado a resorte.
- Apoye o bloquee con seguridad cualquier componente elevado de la máquina antes de trabajar en él.
- Evite las llamas, las chispas y no fume cerca de combustibles, fluido hidráulico u otro material inflamable como los residuos de los cortes.

# Realización de mantenimiento con seguridad

Fije una etiqueta con la advertencia “NO PONER EN FUNCIONAMIENTO” en todas las palancas de control y retire la llave de contacto si la cortadora de césped no debe ser utilizada. Llévese la llave.

Instale dispositivos de apoyo aprobados cuando trabaja debajo o cerca de equipos elevados.

**¡ADVERTENCIA!** Las cortadoras de césped u otros equipos elevados no apoyados pueden caerse de manera imprevista. **Nunca se introduzca debajo de equipos elevados si no están apoyados en dispositivos de apoyo aprobados.** La caída de equipos podría resultar en una lesión grave o la muerte por aplastamiento.

Retire sólo las guardas o cubiertas que permiten acceder a la zona donde se realizarán servicios. Vuelva a colocar todas las guardas y cubiertas cuando el trabajo esté terminado.



Use una “etiqueta que indique No poner en funcionamiento”

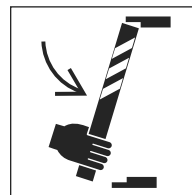

Utilice dispositivos de apoyo aprobados



Vuelva a colocar todas las guardas

# Realización de mantenimiento con seguridad

## Use ventilación adecuada

Si es necesario hacer funcionar un motor en una zona cerrada, elimine del área las emanaciones de escape con una extensión del caño de escape. Si no tiene esa extensión, asegúrese de abrir las puertas y dejar entrar aire del exterior.

**¡ADVERTENCIA!** Evite posibles lesiones. **Nunca trabaje en la maquinaria con el motor en funcionamiento salvo que así lo indiquen los manuales del fabricante para un servicio en particular.**

**¡ADVERTENCIA!** **Nunca haga funcionar ningún tipo de motor sin la ventilación adecuada: LAS EMANACIONES DEL ESCAPE PUEDEN SER MORTALES.**

## Use gatos y malacates con cuidado

Los soportes o bloques de seguridad deben ubicarse en una parte rígida de la cortadora. No ubique soportes debajo de ejes o apoyos de ruedas que puedan girar.

Si debe trabajar debajo de equipos elevados, siempre use bloques de madera (**no de concreto**), soportes de gato u otros soportes rígidos y estables. Cuando use gatos o malacates, siempre asegúrese de que están correctamente apoyados.

**¡ADVERTENCIA!** Evite posibles lesiones por aplastamiento. **Nunca use bloques de concreto para apoyo.** Pueden colapsar bajo cargas incluso livianas.

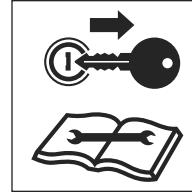

Retire la llave y lea el manual de mantenimiento

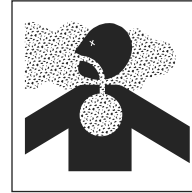

Ventile la zona de trabajo

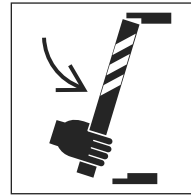

Use un apoyo adecuado para los equipos elevados

Asegúrese de que los malacates o gatos que usa estén en buenas condiciones. Nunca use gatos con piezas rajadas, dobladas o retorcidas. Nunca use cables pelados, retorcidos o pellizcados. Nunca use ganchos doblados o deformados.

# Realización de mantenimiento con seguridad

## Prácticas de seguridad para tareas de mantenimiento comunes

### Riesgos del combustible

**¡ADVERTENCIA!** Siempre use recipientes y/o equipos de distribución de combustible aprobados.

Los combustibles son inflamables; por eso, debe cumplir estas prácticas con el fin de reducir la posibilidad de un accidente grave.

- Apague el motor y la ignición mientras carga combustible.
- Siempre conecte a tierra la boquilla de combustible contra el cuello de llenado del depósito para evitar chispas.
- Mantenga las chispas y llamas abiertas alejadas del combustible.
- No fume mientras carga combustible o manipula recipientes con combustible.
- No corte ni suelde en líneas, tanques o recipientes de combustible ni cerca de ellos.
- No llene el depósito en exceso o derrame combustible. Limpie el combustible derramado de inmediato.

### Riesgos del refrigerante de motor

Los sistemas de refrigeración con líquidos acumulan presión a medida que el motor se calienta; **tenga suma precaución antes de retirar la tapa del radiador.**

Asegúrese de:

- Detener el motor y esperar que el sistema se enfríe.
- Usar ropa de protección y anteojos de seguridad.
- Girar la tapa del radiador lentamente hasta el primer tope para permitir que la presión escape antes de retirar la tapa por completo.



No fumar; evitar las llamas abiertas

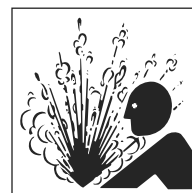

Retire la tapa del radiador lentamente



# Realización de mantenimiento con seguridad

## Riesgos del sistema hidráulico

El sistema hidráulico se encuentra bajo presión siempre que el motor está funcionando; puede conservar presión incluso después de apagar el motor. Haga funcionar todos los controles hidráulicos incluyendo el control hidráulico auxiliar después de que el motor esté apagado. Alivie la presión atrapada en las líneas después de que los accesorios están apagados y apoyados en el suelo.

Durante la inspección del sistema hidráulico:

- Espere que el fluido se enfríe antes de desconectar las líneas. El fluido hidráulico caliente puede causar **QUEMADURAS GRAVES**.
- **No** use las manos para verificar la presencia de fugas. En cambio, use un cartón o papel para buscar fugas.
- Use protección ocular adecuada. El fluido hidráulico puede causar lesiones oculares permanentes.

**¡ADVERTENCIA!** El fluido hidráulico bajo presión pueden penetrar la piel o los ojos y causar lesiones graves, ceguera o la muerte. Las fugas de fluido bajo presión pueden no ser visibles. **Utilice un cartón o una madera para buscar fugas, no la mano. Use una protección facial o antiparras de seguridad para proteger los ojos.** Si el fluido se inyecta en la piel, debe ser extraído dentro de las próximas pocas horas por personal médico familiarizado con este tipo de lesión.

Cuando ventila o llena el sistema hidráulico, afloje la tapa de llenado con lentitud y retírela gradualmente.

**Nunca** restablezca una válvula de alivio del sistema hidráulico a una presión mayor que la recomendada por el fabricante.

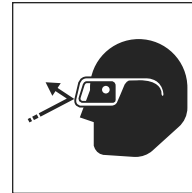

Use protección ocular



El fluido a alta presión puede inyectarse en el cuerpo

# Realización de mantenimiento con seguridad

## Riesgos del sistema eléctrico

Antes de trabajar en el sistema eléctrico, desconecte los cables de la batería.

- Retire primero los cables negativos (-) de la batería.
- Al reconectar la batería, conecte los cables negativos (-) de la batería al final.

El líquido del interior de las baterías contiene ácido, que es un **VENENO** y puede causar **QUEMADURAS QUÍMICAS GRAVES**.

## Evite lesiones

- Use una protección facial para evitar el contacto con los ojos.
- Use guantes y ropa resistentes a los productos químicos para mantener al electrolito alejado de la piel y la ropa común.

**¡ADVERTENCIA!** El contacto con el electrolito daña los ojos y la piel. **Siempre use una protección facial para evitar que el electrolito penetre en los ojos.** Si el electrolito entra en contacto con los ojos, enjuague de inmediato con agua limpia y busque atención médica.

**Use guantes de caucho y ropa de protección para mantener el electrolito lejos de la piel.** Si el electrolito entra en contacto con la piel o la ropa, lave de inmediato con agua limpia.

**Si se ingiere,** busque atención médica de inmediato. **NUNCA** proporcione líquidos que induzcan el vómito.

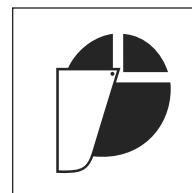

Use protección facial

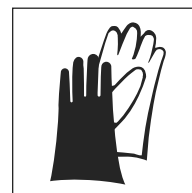

Use indumentaria de protección

# Realización de mantenimiento con seguridad

## Evite explosiones

**¡ADVERTENCIA!** Evite posibles lesiones graves por explosiones. Las baterías de plomo-ácido producen gases sumamente explosivos, especialmente durante la carga. **Mantenga alejados los arcos, las chispas, las llamas y el tabaco encendido.**

- No fume cerca de las baterías.
- Mantenga los arcos, las chispas y llamas abiertas alejadas de las baterías.
- Proporcione ventilación adecuada.

**Nunca** revise la batería colocando un objeto metálico entre los bornes: la chispa resultante podría causar una explosión.

**¡ADVERTENCIA!** Evite posibles lesiones graves por explosiones de baterías. **No cargue baterías ni arranque con refuerzo el motor si la batería está congelada.** Caliente a 60 °F (15,5 °C) o la batería puede explotar y causar lesiones graves.

Reglas de seguridad durante el arranque con refuerzo de batería:

- Siga las instrucciones para el “arranque con refuerzo de batería” correcto como se especifica en el manual del fabricante.

- Asegúrese de que las máquinas no se estén tocando.
- Observe la polaridad de las baterías y conexiones.
- Realice la conexión final de cable al motor o al punto de tierra más alejado de la batería. Nunca realice la conexión final en el arrancador o la batería muerta: las chispas pueden encender gases explosivos presentes en la batería.
- Cuando desconecta cables después de un arranque con puente, retire los cables en el orden inverso al de la conexión (es decir, la conexión final primero).

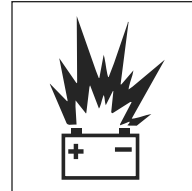

Evite las chispas y las llamas abiertas cerca de las baterías

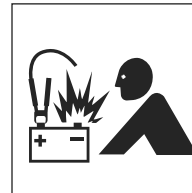

Para el arranque con refuerzo, observe la polaridad y realice la conexión final en el punto de descarga a tierra

# Realización de mantenimiento con seguridad

## Mantenimiento de neumáticos y ruedas

Revise los neumáticos y las ruedas a diario porque la estabilidad del tractor y la cortadora de césped puede verse significativamente afectada por la presión de los neumáticos o daños en los neumáticos o en las ruedas.

Revise los neumáticos para verificar:

- La presión correcta.
- Cortes y protuberancias.
- Clavos u otras pinchaduras.
- Desgaste desparejo o excesivo.
- Estado de los vástagos y tapas de las válvulas.

Revise las ruedas para verificar:

- Daños en las llantas.
- Tuercas o pernos faltantes o flojos.
- Desalineación.

Todos los servicios de neumáticos deben ser realizados por un centro de servicios para neumáticos cualificado o por una persona de servicio autorizada debidamente capacitada en los procedimientos y el uso del equipo de seguridad destinado a los servicios de neumáticos.

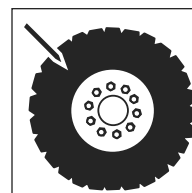

Revise los neumáticos y las ruedas en busca de daños

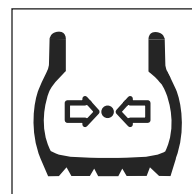

Mantenga la presión correcta en los neumáticos

# Realización de mantenimiento con seguridad

## Mantenimiento de neumáticos y ruedas (continuación)

**¡ADVERTENCIA!** Los tipos de ruedas y neumáticos que generalmente se encuentran en estos equipos requieren cuidados especiales al realizar servicios para evitar lesiones graves o la muerte.

No infle los neumáticos por encima de la presión recomendada. Asegúrese de volver a colocar el lastre de los neumáticos si está instalado. Consulte las especificaciones del fabricante para ver los requisitos de lastre.

Mantenga las tuercas de las ruedas apretadas según las recomendaciones del fabricante.

Es normal que la presión de los neumáticos aumente durante el funcionamiento; NO se debe reducir.

Nunca vuelva a inflar un neumático que se ha desinflado mucho o por completo sin retirar el neumático de la rueda. Haga inspeccionar atentamente el neumático y la rueda para detectar daños antes de volverlos a armar.

Al agregar aire a un neumático, hágalo desde cierta distancia. Use una manguera larga con mandril de autofijación. Siempre párese detrás de la trocha cuando ajusta la presión de un neumático.

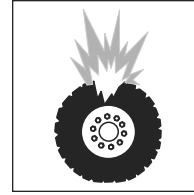

**Evite la explosión de los neumáticos**

No infle neumáticos con gases inflamables o con sistemas que usan un inyector de alcohol.

Nunca corte o suelde una rueda con un neumático inflado instalado en ella. Esto podría causar descompresión explosiva.

Verifique que el tamaño del neumático y la rueda coincidan correctamente.

Cuando reemplaza neumáticos, asegúrese de que sean de la clasificación adecuada especificada por el fabricante.

Los neumáticos no deben funcionar a velocidades más altas que las nominales. La mayoría de los neumáticos para agricultura están clasificados para una velocidad máxima de 20 mph (32 km/h).

# Realización de mantenimiento con seguridad

## Servicio y reparaciones completas antes de liberar la máquina

Apriete todos los pernos, accesorios y conexiones con las torsiones especificadas por el fabricante.

Instale todas las guardas, cubiertas y escudos después de realizar los servicios. Reemplace o repare los que estén dañados. Llene y recargue los sistemas a presión sólo con los fluidos aprobados o recomendados por el fabricante.

Arranque el motor y revise para detectar fugas. (Consulte la página 23, **Riesgos del sistema hidráulico**.) Haga funcionar todos los controles para asegurarse de que el tractor y la cortadora de césped funcionan correctamente. Pruebe la máquina si es necesario. Después de las pruebas, apague y verifique el trabajo realizado. ¿Falta algún pasador, arandela, tuerca de seguridad, etc.? Vuelva a revisar todos los niveles de fluidos antes de liberar la máquina para el funcionamiento.

Todas las piezas deben ser inspeccionadas durante la reparación y deben reemplazarse si están gastadas, rajadas o dañadas. Las piezas excesivamente gastadas o dañadas pueden fallar y causar lesiones o la muerte.

Reemplace cualquier letrero dañado o ilegible.



**Verifique el trabajo de servicio cuando está completo**

## Mantenimiento de las hojas de la cortadora

No corra riesgos usando hojas dañadas o dobladas. Los fabricantes de cortadoras de césped de la Asociación de Fabricantes de Equipos (Association of Equipment Manufacturers, AEM) y la Asociación de Fabricantes de Equipos para Agricultura (Farm Equipment Manufacturers Association, FEMA) piden que las hojas de cortadoras NO se reutilicen, enderecen, refuercen en su superficie o suelden. Si una hoja rota es arrojada por una cortadora, podrían producirse lesiones graves o la muerte.

# Realización de mantenimiento con seguridad

## Mantenimiento de las hojas de la cortadora (continuación)

- **¿Cómo están hechas las hojas de la cortadora de césped?** Están hechas acero para resortes de aleación de alta resistencia. Se forjan en caliente y se les da forma para cumplir con las especificaciones individuales del fabricante; luego, se tratan y templean a un estado dúctil, de alta resistencia para reducir la posibilidad de rupturas durante el corte. Las hojas se prueban para garantizar que cumplan con las normas de resistencia, dureza y ductilidad. Si una hoja no cumple con alguna de estas especificaciones, no se utilizará en la cortadora de césped.
- **¿Qué sucede cuando se dobla una hoja de la cortadora?** Se necesita una gran fuerza de impacto para doblar la hoja. Esta fuerza de impacto a menudo resulta en que las hojas se agujerean o marcan. Una vez que una hoja está dañada por un agujero o una marca, es mucho más probable que ocurra una falla de la hoja. Cuando una hoja está gravemente doblada, puede crearse una rajadura microscópica en ella. Enderezar la hoja no quita o repara esta rajadura, sino que puede causar rajaduras adicionales. Tensiones adicionales durante los trabajos de corte pueden resultar en una falla imprevista de la hoja.
- **Evite doblar las hojas.** Contribuya a prevenir que las hojas de la cortadora se doblen o rajen evitando el contacto con objetos sólidos. Las hojas de la cortadora de césped están destinadas a cortar hierba, arbustos, vegetación leñosa y árboles y ramas pequeños. No están diseñadas para entrar en contacto con objetos sólidos como roca, cemento o postes de acero. Inspeccione la zona antes de usar la cortadora. Retire o marque claramente los objetos sólidos y corte alrededor de ellos.
- **Sustituya las hojas dañadas!** Inspeccione las hojas de la cortadora diariamente o después de golpear algún objeto sólido. Si una hoja de la cortadora de césped se daña (está doblada, agujereada, rajada) o desgasta más del 25 por ciento del tamaño original, debe retirarse y sustituirse con una nueva. Siempre use las hojas originales del fabricante. Las hojas de marcas no originales pueden no cumplir con los requisitos de resistencia, dureza y ductilidad del fabricante de la cortadora.
- **No corra riesgos usando hojas dañadas o dobladas.** El uso de una hoja de cortadora dañada o enderezada puede resultar en la ruptura de la hoja y que la hoja sea arrojada hacia el operador o una persona ajena causando una lesión grave o la muerte. El precio de una nueva hoja es bajo en comparación con la posibilidad de una lesión grave que podría resultar de una hoja doblada o rota arrojada por la cortadora

## Palabras finales para el usuario

Acaba de terminar de leer el Manual de la cortadora de césped industrial y para agricultura AEM. Es imposible que este manual abarque todas las situaciones de seguridad que se podría encontrar a diario. Su conocimiento de estas precauciones de seguridad y de su cumplimiento de las reglas básicas de seguridad

contribuirán a formar un buen juicio en todas las situaciones. Nuestro objetivo es ayudarlo a desarrollar, establecer y mantener buenos hábitos de seguridad para que la operación de una cortadora de césped industrial y para agricultura le resulte más fácil y más segura.

Éste es otro manual de una serie publicada por AEM sobre la operación de maquinaria en condiciones de seguridad. Muchas de las ilustraciones de este manual de seguridad se pueden encontrar y descargar en <http://pictorials.aem.org>. Para obtener publicaciones adicionales, visite nuestro sitio web en [www.safetymaterials.org](http://www.safetymaterials.org).



ASOCIACIÓN DE FABRICANTES  
DE EQUIPOS

Correo electrónico: [safetymaterials@aem.org](mailto:safetymaterials@aem.org)  
[www.aem.org](http://www.aem.org)

# INTRODUCTION SECTION

Introduction Section 2-1

# INTRODUCTION

This Boom Mower is designed with care and built with quality materials by skilled workers. Proper assembly, maintenance, and operating practices, as described in this manual, will help the owner/operator get years of satisfactory service from the machine.

The purpose of this manual is to familiarize and instruct. The Assembly Section instructs the owner/operator in the correct assembly of the Mower using standard and optional equipment. The Parts Listing section is designed to familiarize the owner/operator with replaceable parts on the Mower. This section provides exploded assembly drawings of each mower component illustrating each piece and the corresponding part number.

Careful use and timely service saves extensive repairs and costly downtime losses. The Operation and Maintenance Sections of the manual train the owner/operator how to work the Mower correctly and attend to appropriate maintenance. The Troubleshooting Guide helps diagnose difficulties with mower and offers solution to the problems.

Safety is of primary importance to the owner/operator and to the manufacturer. The first section of this manual includes a list of Safety Messages, that, if followed, will help protect the operator and bystanders from injury or death. Many of the Safety Messages will be repeated throughout the manual. The owner/operator/dealer should know these Safety Messages before assembly and be aware of the hazards of operating this mower during assembly, use, and maintenance. The Safety Alert Symbol combined with a Signal Word, as seen below, is intended to warn the owner/operator of impending hazards and the degree of possible injury faced when operating this machine.



Indicates an imminently hazardous situation that, if not avoided, WILL result in DEATH OR VERY SERIOUS INJURY.



Indicates an imminently hazardous situation that, if not avoided, COULD result in DEATH OR SERIOUS INJURY.



Indicates an imminently hazardous situation that, if not avoided, MAY result in MINOR INJURY.

**Important**

Identifies special instructions or procedures that, if not strictly observed, could result in damage to, or destruction of the machine, attachments or the environment.

**NOTE:** *Identifies points of particular interest for more efficient and convenient operation or repair.*

# INTRODUCTION

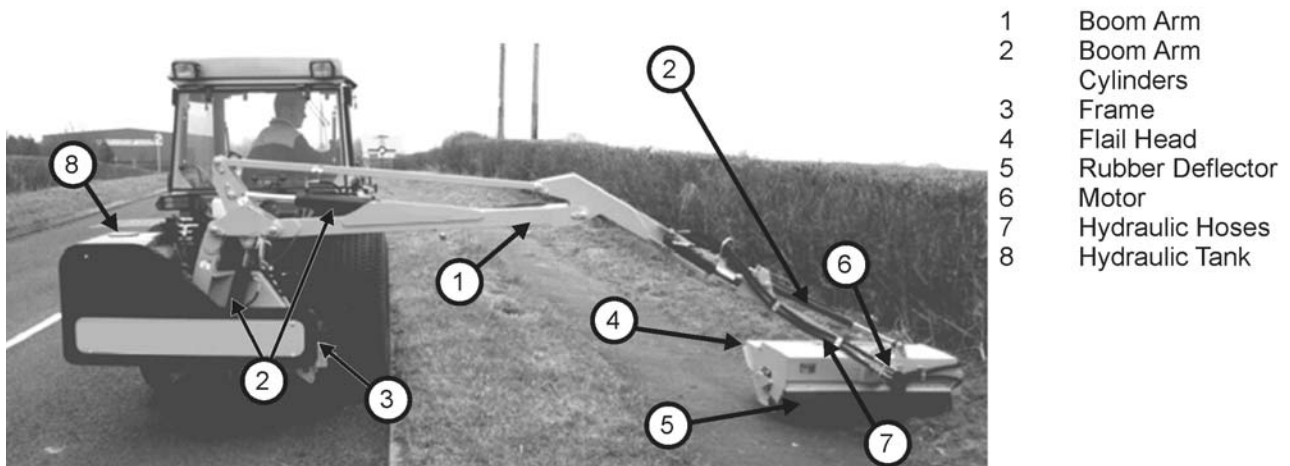

INTRODUCTION

These hydraulically driven hedge cutters are designed for light-duty work. They can control grass and weeds on highways or industrial sites.

Boom Reach (with flail) 13' 8".

Fits tractors as small as 45 PTO HP

Parallel arm geometry allows reach adjustment without requiring constant height adjustment.

Totally independent hydraulics with dual rotor rotation for upward or downward cutting.

Hydraulic break-away safety mechanism

Simple cable controlled in-cab controls.

"Wire Trap" system is included on each flail head to keep loose wires from rotor entanglement.

Flail head includes adjustable front guard for protection from thrown objects.

## POWER ARM ATTACHMENTS

Flail Mower - 39"

Sickle Bar Mower

## DIRECTION

Throughout this Manual front and rear, left and right are determined by the normal direction of travel, the same as driving an automobile.

# INTRODUCTION

## ATTENTION OWNER/ OPERATOR

BEFORE OPERATING THIS MACHINE:

1. Carefully read the Operator's Manual, completely understand the Safety Messages and instructions, and know how to operate correctly both the Mower and Power Unit.
2. Fill out the Warranty Card in full. Be sure to answer all questions, including the Serial Number of the Mower. Mail promptly using the return envelope included with the Operator's Manual.

**NOTE:** Warranties are honored only if completed "Owner Registration and Warranty" forms are received by Alamo Group within thirty days of delivery of the mower.

3. Record the Mower Model and Serial Numbers on the Warranty page at the end of the Operator's Manual. Keep this as part of the permanent maintenance file for the Mower.

<b>⚠ WARNING</b>	<b>⚠ ADVERTENCIA</b>
<p><b>Non-genuine parts can fail catastrophically. TO AVOID SERIOUS INJURY OR DEATH:</b></p> <ul style="list-style-type: none"> <li>• ONLY use genuine ALAMO INDUSTRIAL replacement parts.</li> <li>• Non-genuine parts can fail creating hazardous conditions for operator and bystanders.</li> </ul> <p>Contact local dealer or ALAMO INDUSTRIAL about repair parts at:</p> <p>1502 E. Walnut, Seguin, TX 78155. Customer Service: 800-882-5762. Email: support@alamo-industrial.com</p> <p style="text-align: right;">D564_1</p>	<p><b>Partes que no son auténticas pueden fallar catastróficamente. PARA EVITAR LESION SERIA O MUERTE:</b></p> <ul style="list-style-type: none"> <li>• Use SOLAMENTE las partes de reemplazo auténticas de ALAMO INDUSTRIAL.</li> <li>• Partes que no son auténticas pueden fallar y causar condiciones peligrosas para el operador y personas presentes.</li> </ul> <p>Contacte a su distribuidor local o ALAMO INDUSTRIAL sobre partes de reparo a:</p> <p>1502 E. Walnut, Seguin, TX 78155. Servicio al Cliente: 800-882-5762. Correo Electronico: support@alamo-industrial.com</p>
<b>IMPORTANT</b>	<b>IMPORTANTE</b>
<p><b>BE AWARE                      <u>BE TRAINED</u></b> <b>BE ALERT                      Before Operating</b> <b>BE ALIVE                      this Mower</b></p>	<p><b>ESTE CONSCIENTE      <u>SEA ENTRENADO</u></b> <b>ESTE ALERTO              Antes de Funcionar</b> <b>ESTE VIVO                  Cortacésped</b></p>
<p>To prevent serious injury to yourself and/or bystanders, be trained in Safe Mowing Practices.</p> <p>Alamo Group Companies, Alamo Industrial, Bush Hog, M&amp;W, Rhino, Schulte, Tiger and Terrain King as well as AEM and FEMA provide training material that is critical for your Safety and the Safety of others when operating this equipment. Make these Safety Procedures an important part of every workday.</p> <p>Read and understand the Operator's Manual.</p> <p>Do not let untrained individuals operate this equipment.</p> <p>Contact your Dealer, AEM (<a href="http://www.aem.org">www.aem.org</a>), FEMA (314-878-2304, <a href="http://www.FarmEquipment.org">www.FarmEquipment.org</a>), or Alamo Group (<a href="http://www.Alamo-Group.com">www.Alamo-Group.com</a>) for information on training material or courses that provide training in Safer Operating Practices for Mowers.</p> <p style="text-align: right;">D564_2</p>	<p>Para prevenir lesiones graves a usted y/o personas presentes, sea entrenado en la Practica de Segar Seguro.</p> <p>Companias de Alamo Group, Alamo Industrial, Bush Hog, M&amp;W, Rhino, Schulte, Tiger y Terrain King asi como AEM y FEMA proporcionan material para entrenar que es esencial para su seguridad y la seguridad de otros al operar este equipo. Haga estos procedimientos de seguridad una parte importante de su dia de trabajo.</p> <p>Lea y entienda el Manual de Operadores.</p> <p>No permita que personas sin entrenamiento funcionen este equipo.</p> <p>Contacte a su distribuidor, AEM (<a href="http://www.aem.org">www.aem.org</a>), FEMA (314-878-2304, <a href="http://www.FarmEquipment.org">www.FarmEquipment.org</a>), o Alamo Group (<a href="http://www.Alamo-Group.com">www.Alamo-Group.com</a>) para la informacion sobre el material de entrenamiento o cursos que ofrecen el entenamiento de Prácticas de Operación para Cortadoras.</p> <p style="text-align: right;">D564</p>



# INTRODUCTION

## ALAMO-INDUSTRIAL LIMITED WARRANTY

INTRODUCTION

### 1. LIMITED WARRANTIES

- 1.01. Alamo Industrial warrants for one year from the purchase date to the original non-commercial, governmental, or municipal purchaser ("Purchaser") and warrants for six months to the original commercial or industrial purchaser ("Purchaser") that the goods purchased are free from defects in material or workmanship.
- 1.02. Manufacturer will replace for the Purchaser any part or parts found, upon examination at one of its factories, to be defective under normal use and service due to defects in material or workmanship.
- 1.03. This limited warranty does not apply to any part of the goods which has been subjected to improper or abnormal use, negligence, alteration, modification, or accident, damaged due to lack of maintenance or use of wrong fuel, oil, or lubricants, or which has served its normal life. This limited warranty does not apply to any part of any internal combustion engine, or expendable items such as blades, shields, guards, or pneumatic tires except as specifically found in your Operator's Manual.
- 1.04. Except as provided herein, no employee, agent, Dealer, or other person is authorized to give any warranties of any nature on behalf of Manufacturer.

### 2. REMEDIES AND PROCEDURES.

- 2.01. This limited warranty is not effective unless the Purchaser returns the Registration and Warranty Form to Manufacturer within 30 days of purchase.
- 2.02. Purchaser claims must be made in writing to the Authorized Dealer ("Dealer") from whom Purchaser purchased the goods or an approved Authorized Dealer ("Dealer") within 30 days after Purchaser learns of the facts on which the claim is based.
- 2.03. Purchaser is responsible for returning the goods in question to the Dealer.
- 2.04. If after examining the goods and/or parts in question, Manufacturer finds them to be defective under normal use and service due to defects in material or workmanship, Manufacturer will:
  - (a) Repair or replace the defective goods or part(s) or
  - (b) Reimburse Purchaser for the cost of the part(s) and reasonable labor charges (as determined by Manufacturer) if Purchaser paid for the repair and/or replacement prior to the final determination of applicability of the warranty by Manufacturer.

The choice of remedy shall belong to Manufacturer.

- 2.05. Purchaser is responsible for any labor charges exceeding a reasonable amount as determined by Manufacturer and for returning the goods to the Dealer, whether or not the claim is approved. Purchaser is responsible for the transportation cost for the goods or part(s) from the Dealer to the designated factory.

### 3. LIMITATION OF LIABILITY.

- 3.01. MANUFACTURER DISCLAIMS ANY EXPRESS (EXCEPT AS SET FORTH HEREIN) AND IMPLIED WARRANTIES WITH RESPECT TO THE GOODS INCLUDING, BUT NOT LIMITED TO, MERCHANTABILITY AND FITNESS FOR A PARTICULAR PURPOSE.
- 3.02. MANUFACTURER MAKES NO WARRANTY AS TO THE DESIGN, CAPABILITY, CAPACITY, OR SUITABILITY FOR USE OF THE GOODS.
- 3.03. EXCEPT AS PROVIDED HEREIN, MANUFACTURER SHALL HAVE NO LIABILITY OR RESPONSIBILITY TO PURCHASER OR ANY OTHER PERSON OR ENTITY WITH RESPECT TO ANY LIABILITY, LOSS, OR DAMAGE CAUSED OR ALLEGED TO BE CAUSED DIRECTLY OR INDIRECTLY BY THE GOODS INCLUDING, BUT NOT LIMITED TO, ANY INDIRECT, SPECIAL, CONSEQUENTIAL, OR INCIDENTAL DAMAGES RESULTING FROM THE USE OR OPERATION OF THE GOODS OR ANY BREACH OF THIS WARRANTY. NOT WITHSTANDING THE ABOVE LIMITATIONS AND WARRANTIES, MANUFACTURER'S LIABILITY HEREUNDER FOR DAMAGES INCURRED BY PURCHASER OR OTHERS SHALL NOT EXCEED THE PRICE OF THE GOODS.
- 3.04. NO ACTION ARISING OUT OF ANY CLAIMED BREACH OF THIS WARRANTY OR TRANSACTIONS UNDER THIS WARRANTY MAY BE BROUGHT MORE THAN TWO (2) YEARS AFTER THE CAUSE OF ACTION HAS OCCURRED.

### 4. MISCELLANEOUS.

- 4.01. Proper Venue for any lawsuits arising from or related to this limited warranty shall be only in Guadalupe County, Texas.
- 4.02. Manufacturer may waive compliance with any of the terms of this limited warranty, but no waiver of any terms shall be deemed to be a waiver of any other term.
- 4.03. If any provision of this limited warranty shall violate any applicable law and is held to be unenforceable, then the invalidity of such provision shall not invalidate any other provisions herein.
- 4.04. Applicable law may provide rights and benefits to purchaser in addition to those provided herein.

### KEEP FOR YOUR RECORDS

ATTENTION: Purchaser should fill in the blanks below for his reference when buying repair parts and/or for proper machine identification when applying for warranty.

Alamo Industrial Implement Model \_\_\_\_\_ Serial Number \_\_\_\_\_

Date Purchased \_\_\_\_\_ Dealer \_\_\_\_\_

ATTENTION:

READ YOUR OPERATOR'S MANUAL

**ALAMO INDUSTRIAL**  
An Alamo Group Company  
Post Office Drawer 549  
Seguin, Texas 78156  
830-379-1480





# **ASSEMBLY SECTION**

Assembly Section 3-1

# ASSEMBLY

## TRACTOR SELECTION

### Linkage Requirements

The PA41 fit almost any tractor with a Category I linkage.

### Linkage Isolation

A linkage isolation facility is necessary for Si models only.

### Check Chains/ Stabilizers

To hold the machine firmly in position, check chains or stabilizer bars must be fitted. It is dangerous to operate the machine without these elements.

### Tractor Relief Valve

For Si models only, tractor relief valve must be set above 160 Bar (2300 PSI).

### Tractor Hydraulic Flow Rates

Oil flow rates are not crucial for Si models.

### P.T.O. Shaft

Tractor must be equipped with live drive-independent PTO shaft to enable forward movement to be halted while the flail head continues to operate.

### Horsepower Requirements

PA41 with cutterbar - 25 HP Minimum

PA41 with flail head - 30 HP Minimum

### Stability Requirements

PA41 with cutterbar - 2866 lbs (1300 kg) minimum tractor weight including front ballast

PA41 with flail head - 3527 lbs (1600 kg) minimum tractor weight including front ballast and with a minimum outside tire width of 55 inches (1.4 meters).

# ASSEMBLY

## TRACTOR PREPARATION

### Fitting Operator Guard

A tractor fitted with a cab that has a safety glass windows should be used whenever possible. This is a basic safety precaution applicable to the use of all flail-type hedge trimmers.

Power arms are supplied with an operator guard kit (Part No. 73 13 324) which must be fitted to the tractor before commencing work.

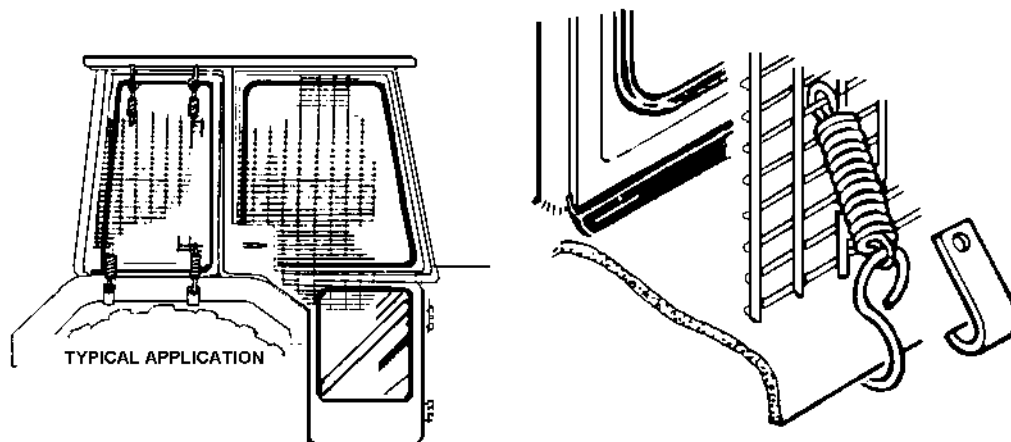

ASM-FL-0092

It consists of two areas of wire mesh which can be shaped to suit and be secured against the cab window with a spring loaded hooks; the upper edge being anchored around the cab gutter and the lower edge around the mudwing.

According to the great range of cabs, it may be necessary to adapt or make brackets to secure the mesh.

If the flail is operated on a tractor that is equipped with a safety frame or roll bar only, an additional frame must be made and fixed to the tractor onto which the guard mesh can be secured. In addition to the guard mesh, a sheet of Polycarbonate transparent glazing must be fitted to the frame to provide further operator protection. This material must also be used when the cab does not have safety glass installed.

The operator guard kit supplied is suitable for all standard applications; i.e., rear mounted on a conventional tractor. For other applications, additional mesh guarding may need to be constructed to give adequate operator protection. A guideline to follow when assessing any additional guarding that may be required is that the operator must always be looking at the flail head through the mesh when it is in any working position.

Polycarbonate transparent sheeting is an impact resistant material which can be readily sawed and shaped according to requirements. Unfortunately, it is susceptible to surface damage and scratching. Therefore, it is advisable to place the material on the inside of the window for protection. No attempt should be made to wipe the sheeting with dirt ingrained cloth.

Toughened grades of polycarbonate sheeting are available under the brand names of "Makrolon", "Tuffak" and "Lexan".

In case of difficulty in obtaining this material locally, contact Alamo Industrial through your normal dealer.

# ASSEMBLY

## Wheel Width

Set wheel widths as wide as possible.

## Ballast Weight

Tractor must be stable while operating the hedge cutters under all conditions. Pay attention when operating on slopes. Front end ballast as well as rear wheel weights to counterbalance the overhang of the flail head should be added as appropriate. On steeply banked ground, it may not be sufficient to depend alone on the counterweight provided by the oil reservoir.

In addition, rear wheel track should be set as wide as possible to increase stability. It will also increase the protection to the reservoir.

## Front Weights

Front weights may be required to place 15% of total outfit weight on the front axle for stable transport on the road and to reduce "crabbing" due to the drag of the cutting unit when working on the ground.

## CLOSED CENTER CONVERSION KIT (81- 30- 059) for Si Models

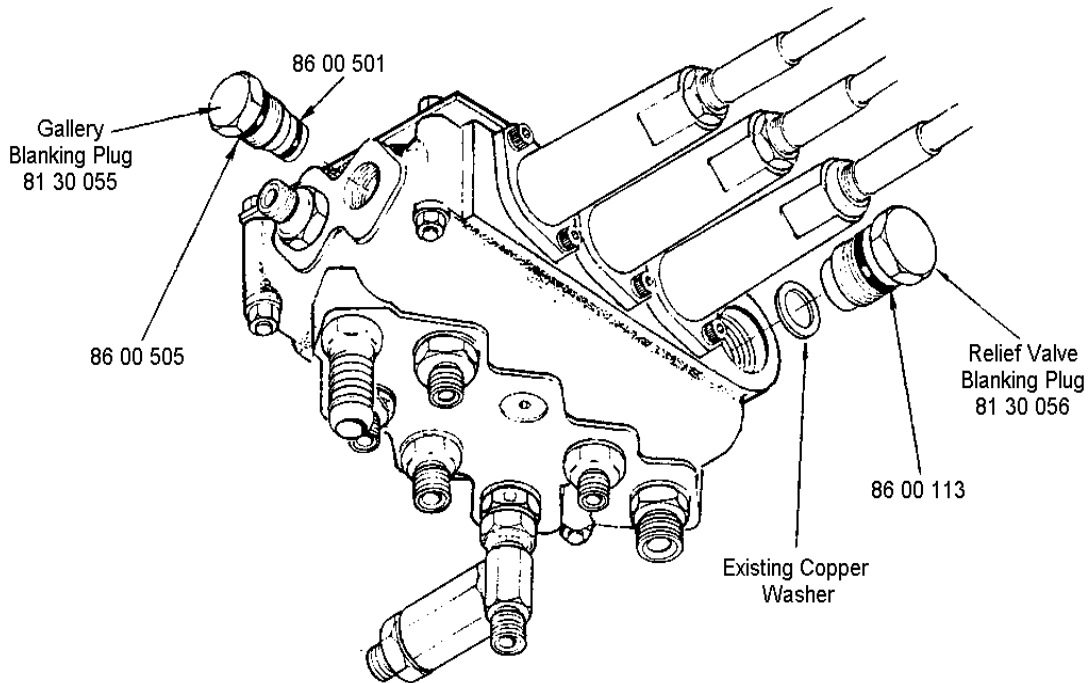

ASM-FL-0093

A Control Valve Conversion Kit (Part No. 8130059) consists of relief valve-blanking plug, which should be installed in place of the existing relief valve, and a pressure gallery blanking plug, which is installed in place of the standard blanking plug at the valve outlet end next to the lift ram gland connection.

**NOTE:** Take care when extracting the relief valve not to damage the copper sealing washer, as it is to be re-used.

When working in this mode the tractor's pressure control valve must not exceed 2500 P.S.I. (170 Bar).

# ASSEMBLY

## DELIVERY

1. The machine is delivered in a partially dismantled condition. To make ready for attachment to the tractor it will be necessary to select a hard level surface
2. Cut the banding straps and remove the attached articles.
3. Fill the reservoir to capacity with oil selected from the chart on Section 3-9 to increase the stability of the machine.
4. Remove and discard the transport strap connecting the flail head to the frame and also the lift ram stop strapped to the rod.

## ATTACHMENT TO TRACTOR

Before commencing, select a firm level site, cut the banding straps and remove loose items and the stabilizer. Leave the transport straps at this stage.

1.

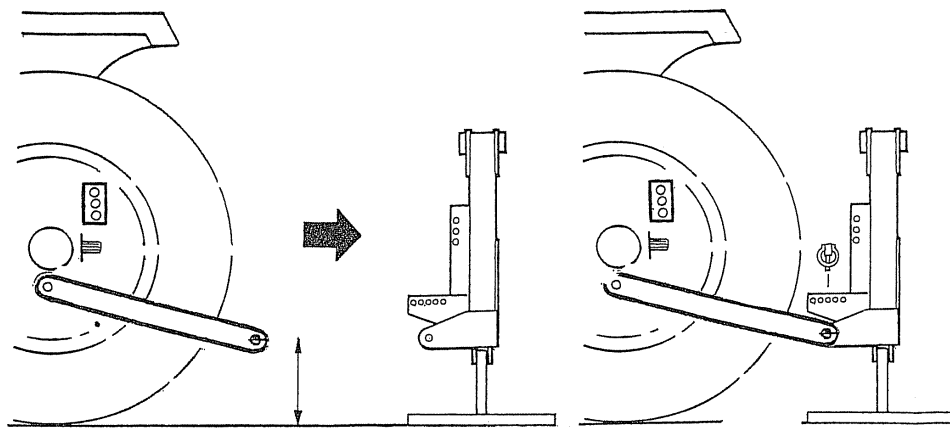

Asm-B-0207

2.

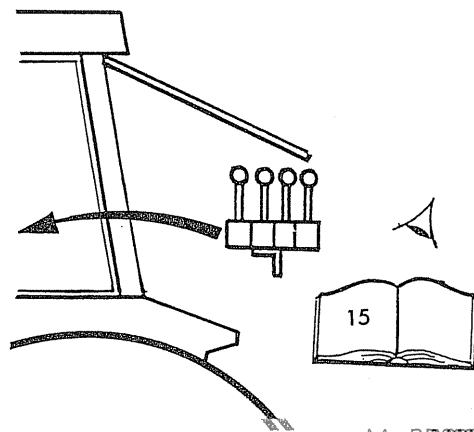

Asm-B-0208

# ASSEMBLY

### 3. Si Only

Connect supply and return hoses to tractor. Supply is taken from the tractor's auxiliary service. Return is direct to the tractor's transmission casing (see tractor's handbook for correct procedure). Extra hoses and fitting may be required.

4. A - Fit the stabilizer nose into the tractor's top link position. Use the highest position available, avoiding any load sensing properties. The bolt on nose of the stabilizer is reversible to accommodate a variety of tractor linkage designs.

B - Stretch out the stabilizer and bolt to the machine using the holes farthest from the tractor that the stabilizer will reach. Do not fully tighten bolts at this stage and do not replace the stabilizer nose quadrant pin.

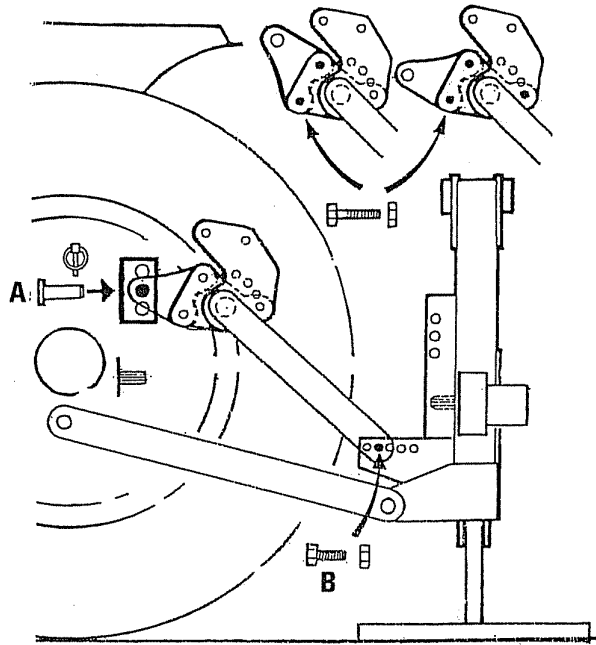

Asm-B-0209

### 5. Fit the machines top link.

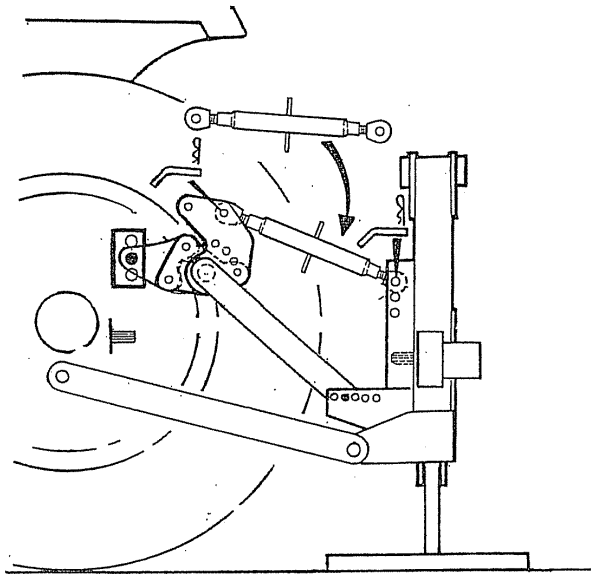

Asm-B-0201 C



# ASSEMBLY

6. Raise machine on tractor's linkage until the tractor's PTO and the machines gearbox stub shaft are approximately in line.

**WARNING:** The quadrant lever of machine controls must be operated from the tractor seat. During this operation, ensure no one is standing on or among the linkage arm or bars.

**NOTE:** As lift occurs, be aware the machinery may tilt slightly.

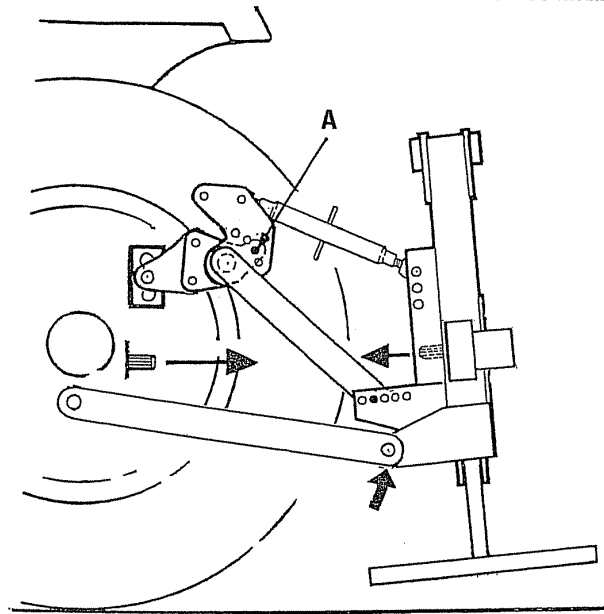

Asm-B-0211

7. Adjust the top link to bring the machines frame vertical.
8. A - Refit the top link nose quadrant pin, fine adjust position using the tractor's draft lift.  
B - Lower tractor linkage control so that machines weight is taken by the yoke.  
C - Fully tighten the stabilizer lower bolts.

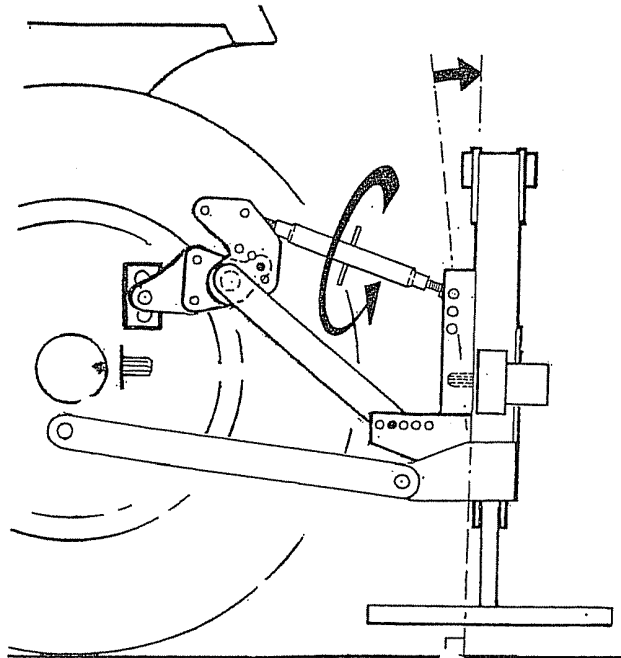

Asm-B-0212

# ASSEMBLY

9. Fill tank with oil. Refer to operator's manual for oil requirements.

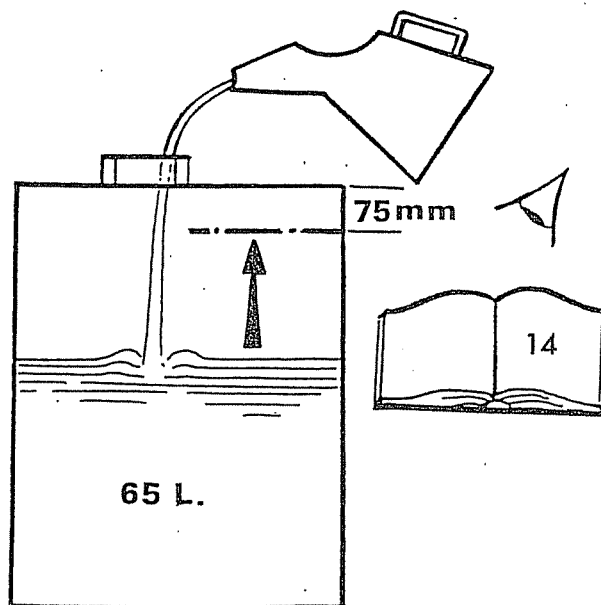

10. Measure PTO and cut to dimension shown. See Maintenance Section for details.

*NOTE: For subsequent use on different tractor's measure again. There must be a minimum of 5.9 in (150 mm) of overlap.*

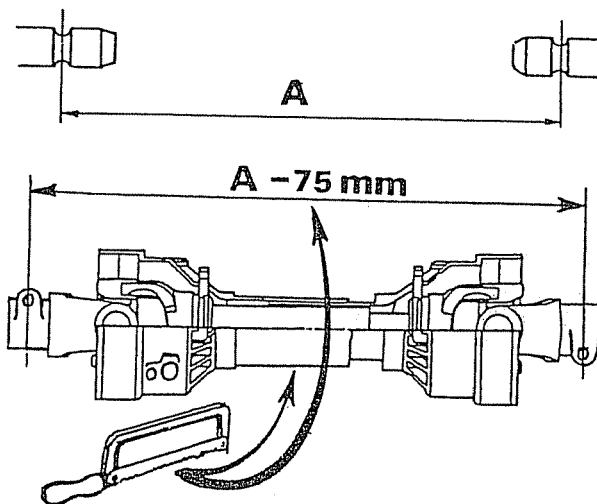

# ASSEMBLY

11. Fit PTO shaft and attach torque chain to a convenient point to prevent the shaft guard rotating.

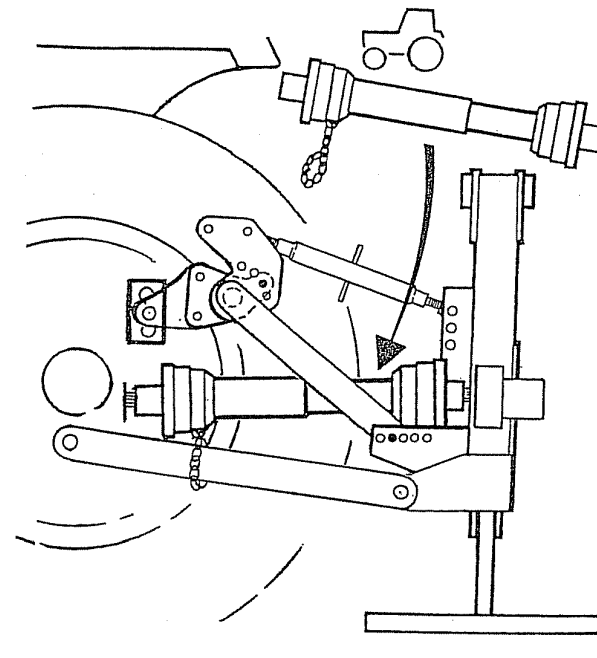

Asm-B-0215

12. Raise the stand legs into the work position and secure.
13. Remove transport strap.
14. With tractor external services activated on Si models or with PTO engaged on Ti models maneuver the arms into a position that will allow the cutter head to be fitted. Fill cutter head and secure with circlip, washers and split pin.
15. Cutterbar only - Engage motor splines in the drive tube and bolt in position with connection uppermost.

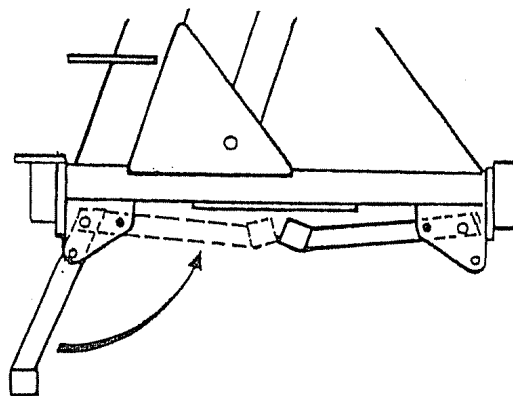

Asm-B-0216

ASSEMBLY

# ASSEMBLY

## ASSEMBLY

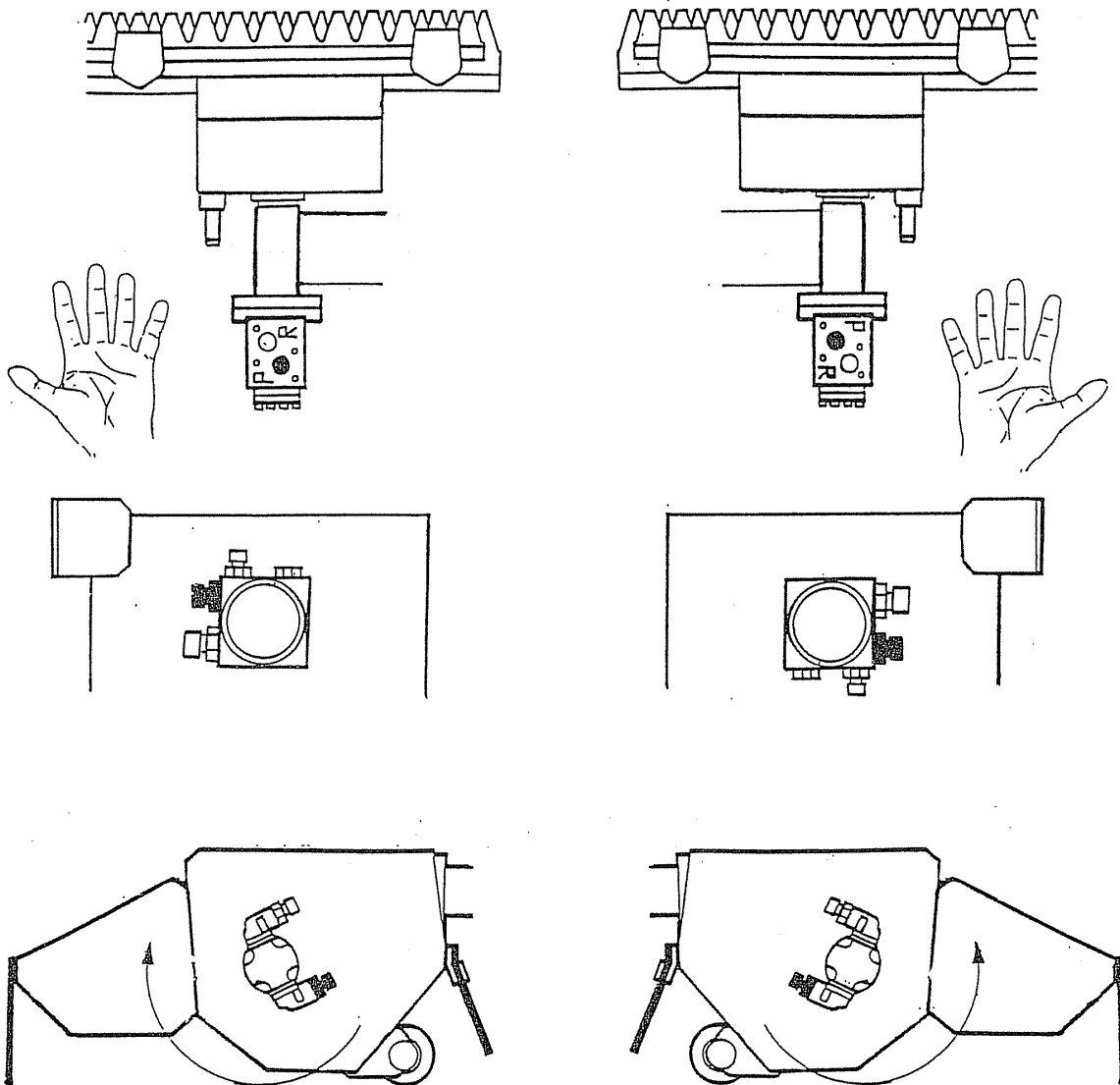

Asm-B-0217

16. With the arms at half reach and with the flail head clear of the ground carry out final adjustment of the lift arm leveling box to bring the main frame horizontal.
17. Tighten check chains and/or stabilizer bars.
18. Carefully operate the machine through its full range of movements while checking that hoses are not strained, pinched, chafed or kinked and that all movements are functioning correctly.
19. Fold the maintenance into the transport position. The machine is now ready to proceed to the work site.

# ASSEMBLY

## FITTING CONTROL UNIT IN CAB

An angled bracket is supplied to provide a mounting location for the control unit.

This bracket may be bolted to the mudwing or cab cladding in a convenient location ensuring that no structural member of the cab or roll bar is drilled.

In deciding the final position of the control box, remember not to exceed the minimum acceptable bend radii of 8" for the cables.

When the control unit is removed from the cab ensure the rubber edge strip is fitted to the mounting bracket to cover any possible sharp edges.

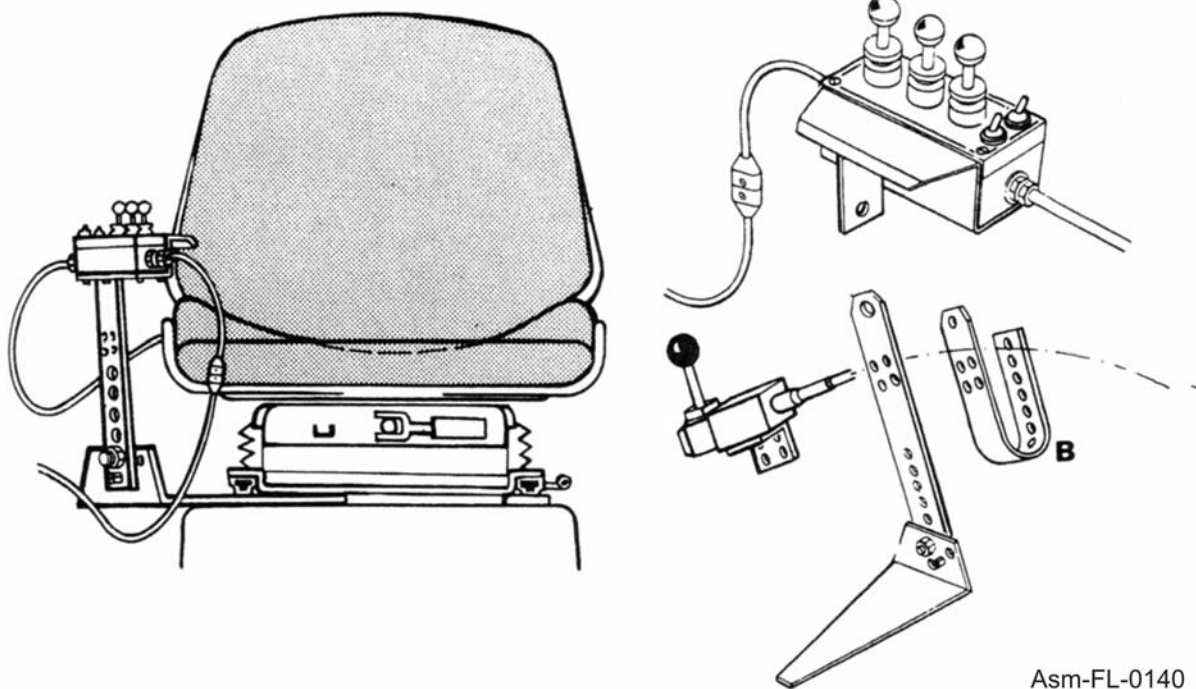

ASSEMBLY

# ASSEMBLY

## OIL REQUIREMENTS

### Tank

The machine is delivered from the factory without oil. Fill the reservoir with a light hydraulic oil as recommended in the chart until the oil level is approximately 2" (50mm) below the top of the tank. The total capacity is approximately 187 Liters (Approx. 41 gallons). DO NOT OVERFILL THE TANK. The oil must have anti-frothing characteristics suitable for use in hydraulic systems.

Supplier	Cold or Temperature Climate	Hot Climate
Castrol	Agricastrol hydraulic oil Hy-spin AWS46	Hy-spin AWS68
Shell	Tellus 46	Tellus 68
Mobil	D.T.E. 25	D.T.E. 26
Esso	Nuto "H" or "A" 46	Nuto "H" or "A" 68
Texaco	Rando HD 46	Rando HD 68
Gulf	Hydrasil 46	Hydrasil 32
B.P.	Energol HLP 46	Energol HLP 68
Dalton	Silkolene Dove 46 or Derwnet 46	Silkolene Dove 68
Elf	Hydrelf 46	Hydrelf 68
ISO VG	46	68
SAE	10W	20

### Gearbox

Check the gearbox oil level. On level ground, it should be filled until oil is visibly level with the lip of the filler plug aperture. Do not attempt to fill by removing the breather as the depth of tapped thread in the casing at this point is insufficient to allow repeated loosening and tightening of the breather plug.

The gearbox capacity is 700 ml (1-1/4 pint use EP 90 gear oil).

# ASSEMBLY

## RUNNING UP PROCEDURE

### Ti Models Only - With Flail Head Only

1. Ensure that the rotor control valve is in "STOP" position, start the tractor, engage PTO and allow the oil to circulate through the return line filter for about 5 minutes without operation of the armhead control lever.
2. Operate the armhead levers through their complete range ensuring that all movements are functioning correctly.
3. Place the flail head at a safe attitude and move the rotor control to "START" position. After initial fluctuation, the rotor should settle to a steady speed. Increase PTO speed to approximately 360 RPM and run for a further 5 minutes before disengaging and stopping tractor.
4. Check the hose runs and observe that they are free from any pinching, chafing, straining or kinks. Recheck the oil level in the tank and top up as necessary.

### Si Models Only - With Cutterbar or Flail Head

1. Ensure PTO lever is in neutral position, and isolate tractor hydraulic linkage. Start the tractor and select external service supply. Allow the tractor to run for several minutes before attempting to operate any of the machine control levers.
2. On operating, move the levers through their complete range ensuring that all movements are functioning correctly.
3. Check the tractor rear axle oil level and top up if necessary.
4. On Cutterbar models, ensure the motor hoses are connected correctly.
5. Place the cutterhead at a safe attitude and bring tractor engine revolutions to 1000 RPM. Engage PTO and allow the rotor to run for several minutes. Do not leave the tractor cab or allow anyone to approach the cutterhead at this time.



Do not allow the pump to continue working if the cutter does not operate. Overheating and serious pump damage to the pump can be caused in a very short time.

6. After running up the machine, increase PTO speed to approximately 360 RPM. Run machine further for 5 minutes to allow the oil to circulate through the return line filter before disengaging the PTO and stopping tractor.
7. Check the hose runs and observe that they are free from any pinching, chafing, straining or kinks. Recheck the oil level in the tank and top up as necessary.

### All models

Replace return filter elements after an initial 12 hours of operation and every 500 hours thereafter.

## REMOVAL FROM TRACTOR

1. Select a firm level site for parking the machine.
2. Lower the stand legs and fix.
3. Raise the machine off the tractor's linkage until the weight is taken off the stabilizer.
4. Remove the stabilizer nose quadrant locking pin.
5. Lower the machine to the ground.
6. Operate machine controls and place the flail head on the ground.
7. Disengage tractor PTO and remove the drive shaft.
8. Unbolt the control unit from the mounting pillar, remove from tractor cab and stow the lever or switchbox clear of the ground.
9. Disconnect the stabilizer from the tractor's top hitch position.
10. Remove draft link pins and drive tractor away.





# OPERATION SECTION

Operation Section 4-1

# OPERATION

## ALAMO INDUSTRIAL PA41 BOOM MOWER OPERATING INSTRUCTIONS

Alamo Industrial Boom Mowers are manufactured with quality material by skilled workers. These mowers are designed for cutting grass and small weeds. The mower is equipped with protective deflectors to prevent objects being thrown from the mower by the blades, however, no shielding is 100% effective. All shields, guards, and deflectors equipped on the mower must be maintained in good operational condition.

It is the operator's responsibility to be knowledgeable of all potential operating hazards and to take every reasonable precaution to ensure oneself, others, animals, and property are not injured or damaged by the mower, tractor, or a thrown object. Do not operate the mower if passersby, pets, livestock, or property are within 300 feet of the unit.

- **All THROWN OBJECT SHIELDING** including, *Front and Rear Deflectors and Skid Shoes are in place and in good condition when mowing.*
- *Mower is adjusted to be close and parallel to ground without exposing blades.*
- **MOWING AREA** *has been inspected and foreign materials and debris have been removed.*
- **PASSERSBY** *are inside enclosed vehicle.*

This section of the Operator's Manual is designed to familiarize, instruct, and educate safe and proper mower use to the operator. Pictures contained in this section are intended to be used as a visual aid to assist in explaining the operation of a boom mower and are not specific to any model. Some pictures may show shields removed for picture clarity. NEVER operate implement without all shields in place and in good operational condition. The operator must be familiar with the mower and tractor and all associated safety practices before operating the mower and tractor. Proper operation of the mower, as detailed in this manual, will help ensure years of safe and satisfactory use of the mower.

**IMPORTANT:** To avoid mower damage, retorque all bolts after the first 10 hours of operation. Refer to the Torque Chart at the end of the Maintenance Section to ensure bolts are properly tightened.

**READ AND UNDERSTAND THE ENTIRE OPERATING INSTRUCTIONS AND SAFETY SECTION OF THIS MANUAL AND THE TRACTOR MANUAL BEFORE ATTEMPTING TO USE THE TRACTOR AND IMPLEMENT.** If you do not understand any of the instructions, contact your nearest authorized dealer for a full explanation. Pay close attention to all safety signs and safety messages contained in this manual and those affixed to the implement and tractor. *OPS-U- 0001*

READ, UNDERSTAND, and FOLLOW the following Safety Messages. Serious injury or death may occur unless care is taken to follow the warnings and instructions stated in the Safety Messages. Always use good common sense to avoid hazards. (SG-2)

**SAFETY INSTRUCTIONS**



**PELIGRO**

Si no lee ingles, pida ayuda a alguien que si lo lea para que le traduzca las medidas de seguridad. (SG-3)

**¡ LEA EL INSTRUCTIVO!**



# OPERATION

## 1. OPERATOR REQUIREMENTS

Safe operation of the unit is the responsibility of a qualified operator. A qualified operator has read and understands the implement and tractor Operator's Manuals and is experienced in implement and tractor operation and all associated safety practices. In addition to the safety messages contained in this manual, safety signs are affixed to the implement and tractor. If any part of the operation and safe use of this equipment is not completely understood, consult an authorized dealer for a complete explanation.

If the operator cannot read the manuals for themselves or does not completely understand the operation of the equipment, it is the responsibility of the supervisor to read and explain the manuals, safety practices, and operating instructions to the operator.

Safe operation of equipment requires that the operator wear approved Personal Protective Equipment (PPE) for the job conditions when attaching, operating, servicing, and repairing the equipment. PPE is designed to provide operator protection and includes the following safety wear:

### **PERSONAL PROTECTIVE EQUIPMENT (PPE)**

- Always Wear Safety Glasses
- Hard Hat
- Steel Toe Safety Footwear
- Gloves
- Hearing Protection
- Close Fitting Clothing
- Respirator or Filter Mask (depends on operating conditions) OPS-U- 0002

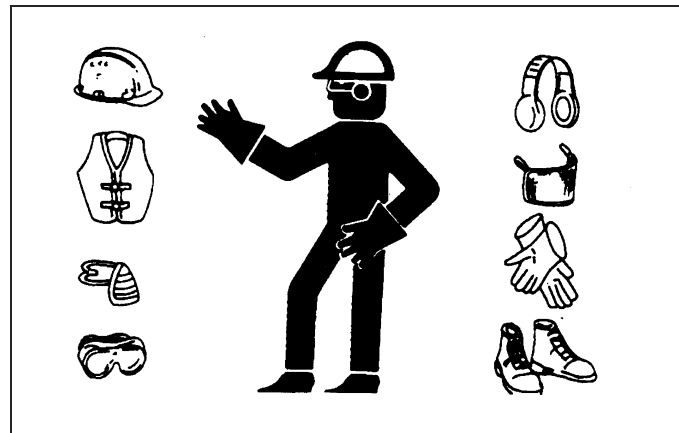

DO NOT use drugs or alcohol immediately before or while operating the Tractor and Implement. Drugs and alcohol will affect an operator's alertness and coordination and therefore affect the operator's ability to operate the equipment safely. Before operating the Tractor or Implement, an operator on prescription or over-the-counter medication must consult a medical professional regarding any side effects of the medication that would hinder their ability to operate the Equipment safely. NEVER knowingly allow anyone to operate this equipment when their alertness or coordination is impaired. Serious injury or death to the operator or others could result if the operator is under the influence of drugs or alcohol. (SG-27)

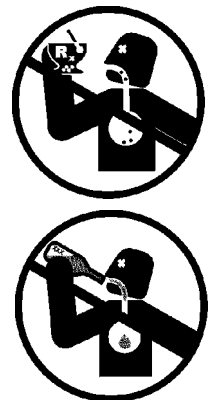

# OPERATION

OPERATION

## 2. Standard Equipment and Specifications

Hitch	3-Point CAT I
Tractor PTO Horsepower (Minimum)	45 HP
Tractor Weight (Minimum)	4410 lbs.
Maximum Horizontal Reach	13' 8"
Maximum Vertical Reach	16' 8"
Cutting Capacity	1"
Hydraulics	Semi-Independent
Approximate Weight with Flailhead	1409 lbs
Oil Tank Capacity	17 Gallons
Output Horsepower	25 HP
Flail Head Option	39"

Parallel Arm Geometry  
Safety Breakaway - Hydraulic  
Heavy Duty Rear Roller  
Front Flap Kit  
Cable Rotor Control - Dual Rotation  
Window Guards

- A. Maximum Reach - Head Horizontal ..... 13'8"
- B. Maximum Reach - Head Vertical ..... 39"
- C. Maximum Height - Head Horizontal..... 9'1"
- D. Maximum Height - Head Vertical ..... 13'11"
- E. Maximum Depth - Head at 45° ..... 16'8"

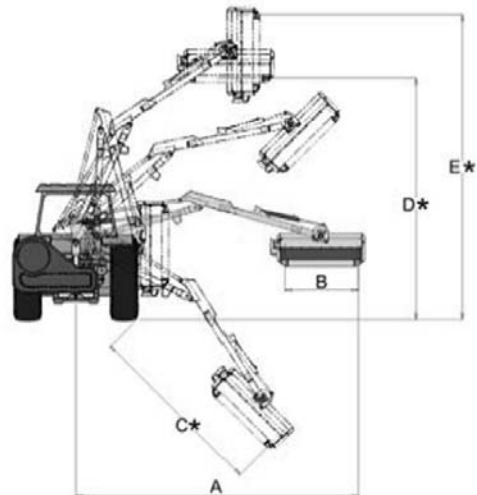

Ops-1564

# OPERATION

## 3. TRACTOR REQUIREMENTS

In addition to tractor horsepower and size required to operate the mower unit, the tractor must also be properly equipped to provide operator protection, to alert approaching vehicle drivers of the tractor's presence, and to ensure tractor stability when mowing with the boom fully extended.

### Tractor Requirements and Capabilities

- Certified approved Roll-Over Protective Structure (ROPS) or ROPS cab and seat belt.
- Operator Protection ..... Tractor must be equipped with protective structure such as operator cage or lexan window to protect operator from thrown object and falling objects
- Tractor Safety Devices ..... Slow Moving Vehicle (SMV) emblem, lighting,
- Tractor Ballast ..... As required to maintain at least 1500 lbs. on left rear tire

### 3.1 ROPS and Seat Belt

The tractor must be equipped with a Roll-Over-Protective-Structure (ROPS) (tractor cab or roll-bar) and seat belt to protect the operator from falling off the tractor, especially during a roll over where the driver could be crushed and killed. Only operate the tractor with the ROPS in the raised position and seat belt fastened. Tractor models not equipped with a ROPS and seat belt should have these life saving features installed by an authorized dealer. OPS-U- 0003



Operate this Equipment only with a Cab Tractor. Always wear seat belts. (SG-45)



### 3.2 Operator Thrown Object Protection

The tractor must be equipped with protective equipment to shield the operator from falling and thrown objects. For cab tractors, the tractor must be equipped with an operator safety screen on its right side or the right side windows must be fitted with a shatter proof safety window. For non-cab tractors, the tractor must be equipped with a ROPS and operator protective safety cage that provides protection to the right and above the operator seat. DO NOT remove the ROPS from non-cab tractors to equip a safety cage.

OPS-B- 0001\_A



Never operate the Tractor and Mower Unit without an OPS (Operators Protective Structure) or Cab to prevent injury from objects thrown from ground or from overhead trimming. Stop mowing if workers or passersby are within 300 feet. (SBM-9)



# OPERATION

### 3.3 Tractor Lighting and SMV Emblem

If the tractor will be operated near or traveled on a public roadway it must be equipped with proper warning lighting and a Slow Moving Vehicle (SMV) emblem which are clearly visible from the rear of the unit. Most tractor's have different settings for operating and transporting lighting. Refer to the tractor operator's manual for using the tractor's light switch and operating the turn signals.

OPS-B- 0017



### 3.4 Tractor Ballast

To ensure tractor stability when operating on flat surfaces the left rear tractor tire **MUST** exert a minimum down force (weight) of 1500 lbs. on the ground when the tractor is on level ground, its boom is fully extended and the mower head is horizontal and two feet above the ground. A tractor that does not meet this criteria is **DANGEROUS** and should not be operated as upset of the unit can occur resulting in possible serious injury and property damage.

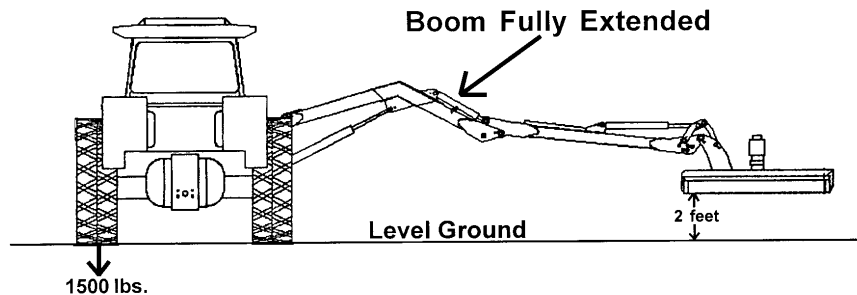

If the unit is operated on slopes greater than 5°, additional counterweight will be required. Operation of the unit on slopes greater than 11 percent (6.4 degrees) is not recommended under any circumstances. On a tractor with a 96" outside to outside tire spread, an 11 percent (6.4 degrees) slope occurs when one rear tractor tire is about 8" lower than the other rear tire. OPS-B- 0018\_C

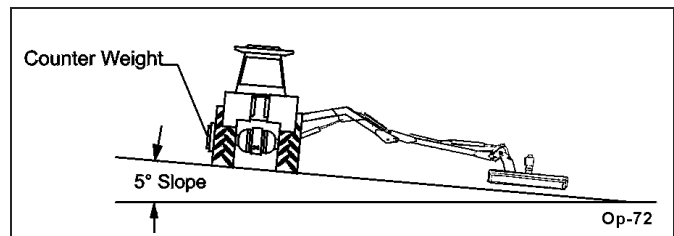

# OPERATION

## **3.5 Tractor Safety Devices**

If transporting or operating the tractor and implement near a public roadway, the tractor must be equipped with proper warning lighting and a Slow Moving Vehicle (SMV) emblem which are clearly visible from the rear of the unit. Lights and a SMV emblem must be equipped directly on implements if the visibility of the tractor warning signals are obscured.

Maintain all manufacturer equipped safety shields and guards. Always replace shields and guards that were removed for access to connect, service, or repair the tractor or implement. Never operate the tractor PTO with the PTO master shield missing or in the raised position. OPS-U- 0004

## **3.6 Tractor Horsepower**

The horsepower required to operate the mower depends on many factors including vegetation to be cut, terrain condition, operator experience, and condition of the mower and tractor. For most mowing condition, the PA41 boom mower requires a tractor with at least 45 HP PTO. Operating the mower with a tractor that does not have adequate power may damage the tractor engine.

## **3.7 3-Point Hitch**

PA41 boom mowers can attach to tractors with a CAT I or II hitch. Refer to the tractor operator's manual for the category of the tractor used. If the hitch does not conform to ASABE Cat I and II dimensions, the mower may not fit or raise properly. Consult an authorized dealer for possible modification procedures to mount nonconforming hitches.

Use the correct hitch pins for the hitch category being used. For Cat II hitches, it requires 1-1/8" lower and 1" upper diameter hitch pins.

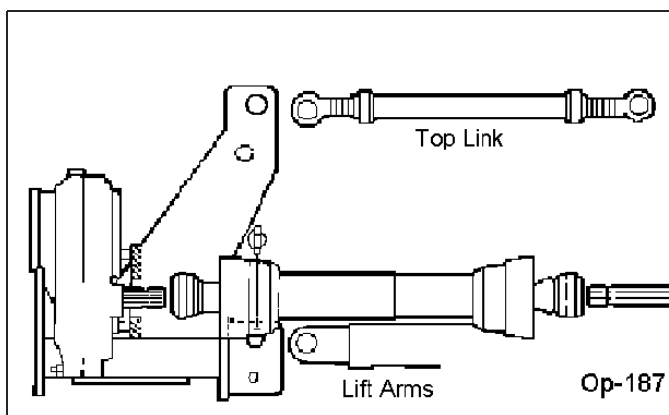

## **3.8 Hydraulics**

The PA41 is available with a Totally Independent Hydraulic System complete with Rotor Rotation Control. The fully independent system is operated by an extra lever on the control console, which allows selection of rotor rotation and all other functions.

## **3.9 Front End Weight**

A minimum of 20% total tractor weight must be maintained on the tractor front end at all times. Front end weight is critical to maintain steering control and to prevent the tractor from rearing up while driving. If the front end is too light, add weight until a minimum of 20% total weight is reached on the front tires. Front weights and weight carriers can be purchased through an authorized tractor dealership. OPS-U- 0005

# OPERATION

## 3.10 Power Take Off (PTO)

Depending on the unit, the mower is designed to operate at a PTO speed of 540 RPM. Most tractors operate at either 540, or a combination of 540 and 1000 RPM PTO speeds. The operating speed of the mower and tractor can be determined by the number of splines on the driveline yoke and PTO output shaft. Those operating at 540 RPM will have a 6-spline shaft and those operating at 1000 RPM will have a 21-spline shaft.

**Note:** Refer to the tractor owner's manual for instructions to change PTO speeds on models that operate at more than one speed.

If operating an older model tractor where the tractor's transmission and PTO utilize one master clutch, an over-running clutch must be used between the PTO output shaft and the driveline of the mower. An authorized tractor dealer can provide the over-running clutch and its installation if needed. OPS-U- 0006\_B



**DO NOT** use a PTO adapter to attach a non-matching Implement driveline to a Tractor PTO. Use of an adapter can double the operating speed of the Implement resulting in excessive vibration, thrown objects, and blade and implement failure. Adapter use will also change the working length of the driveline exposing unshielded driveline areas. Serious bodily injury and/or equipment failure can result from using a PTO adapter. Consult an authorized dealer for assistance if the Implement driveline does not match the Tractor PTO.

(S3PT-14)



Never operate the Tractor and Mower if the Implement input driveline is directly connected to the Tractor transmission. Tractor braking distances can be substantially increased by the momentum of the rotating Mower blades driving the Tractor transmission even though the Tractor clutch has been disengaged. Install an over running clutch between the Tractor PTO and the Mower driveline to prevent this potentially dangerous situation. (S3PT-16)

## 4. GETTING ON AND OFF THE TRACTOR

Before getting onto the tractor, the operator must read and completely understand the implement and tractor operator manuals. If any part of either manual is not completely understood, consult an authorized dealer for a complete explanation. OPS-U- 0007



Do not mount or dismount the Tractor while the tractor is moving. Mount the Tractor only when the Tractor and all moving parts are completely stopped. (SG-12)





# OPERATION

## 4.1 Boarding the Tractor

Use both hands and equipped handrails and steps for support when boarding the tractor. Never use control levers for support when mounting the tractor. Seat yourself in the operator's seat and secure the seat belt around you.

Never allow passengers to ride on the tractor or attached equipment. Riders can easily fall off and be seriously injured or killed from falling off and being ran over. It is the operator's responsibility to forbid all extra riders at all times. *OPS-U- 0008*



Never allow children or other persons to ride on the Tractor or Implement. Falling off can result in serious injury or death. (SG-10)



Never allow children to operate or ride on the Power Unit or Implement. (SPU-17)



## 4.2 Dismounting the Tractor

Before dismounting, park the tractor and implement on a reasonably level surface, apply the parking brake, idle the engine down, disengage the PTO, and lower the implement to the ground. Shut down the tractor engine according to the operator's manual, remove the key, and wait for all motion to completely stop. Never leave the seat until the tractor, its engine and all moving parts have come to a complete stop.

Use hand rails and steps when exiting the tractor. Be careful of your step and use extra caution when mud, ice, snow or other matter has accumulated on the steps or hand rails. Use all handrails and steps for support and never rush or jump off the tractor. *OPS-U- 0009*



BEFORE leaving the tractor seat lower the implement, set the parking brake and/or set the tractor transmission in parking gear, disengage the PTO, stop the engine, remove the key, and wait for all moving parts to stop. Place the tractor shift lever into a low range or parking gear to prevent the tractor from rolling. Never dismount a Tractor that is moving or while the engine is running. Operate the Tractor controls from the tractor seat only. (SG-9)

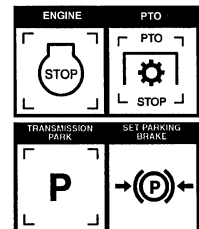

# OPERATION

## 5. STARTING THE TRACTOR

The operator must have a complete understanding of the placement, function, and operational use of all tractor controls before starting the tractor. Review the tractor operator's manual and consult an authorized dealer for tractor operation instructions if needed.

Essential Tractor Controls:

- Locate the ignition key/switch
- Locate the engine shut off control
- Locate the hydraulic control levers
- Locate the light control lever
- Locate the brake pedals and clutch
- Locate the PTO control
- Locate the 3 point hitch control lever
- Locate the boom operating controls (joystick or valve bank)

Before starting the tractor ensure the following:

- Conduct all pre-start operation inspection and service according to the tractor operator's manual.
- Make sure all guards, shields, and other safety devices are securely in place.
- The parking brake is on.
- The tractor transmission levers are in park or neutral.
- The boom operating controls are in the neutral and off position.
- The PTO control lever is disengaged.
- The hydraulic remote control levers are in the neutral position.

Refer to the tractor owner's manual for tractor starting procedures. Only start the tractor while seated and belted in the tractor operator's seat. Never bypass the ignition switch by short circuiting the starter solenoid. After the tractor engine is running, avoid accidental contact with the tractor transmission to prevent sudden and unexpected tractor movement. *OPS-B- 0003*



Never run the Tractor engine in a closed building or without adequate ventilation. The exhaust fumes can be hazardous to your health. (SG-23)



Start tractor only when properly seated in the Tractor seat. Starting a tractor in gear can result in injury or death. Read the Tractor operators manual for proper starting instructions. (SG-13)



# OPERATION

## **6. PRE-OPERATION INSPECTION AND SERVICE**

Before each use, a pre-operation inspection and service of the implement and tractor must be performed. This includes routine maintenance and scheduled lubrication, inspecting that all safety devices are equipped and functional, and performing needed repairs. DO NOT operate the unit if the pre-operation inspection reveals any condition affecting safe operation. Perform repairs and replacement of damaged and missing parts as soon as noticed. By performing a thorough pre-operation inspection and service, valuable down time and repair cost can be avoided. OPS-U-0029



Periodically inspect all moving parts for wear and replace when necessary with authorized service parts. Look for loose fasteners, worn or broken parts, and leaky or loose fittings. Make sure all pins have cotter pins and washers. Serious injury may occur from not maintaining this machine in good working order. (SG-21)

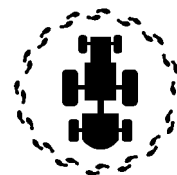

### **6.1 Tractor Pre-Operation Inspection/Service**

Refer to the tractor operator's manual to ensure a complete pre-operation inspection and scheduled service is performed according to the manufacturers recommendations. The following are some of the items that require daily service and inspection:

- Tire condition/air pressure
- Wheel lug bolts
- Steering linkage
- PTO shield
- SMV sign is clean and visible
- Tractor's lights are clean and functional
- Tractor Seat belt is in good condition
- Tractor ROPS is in good condition
- ROPS is in the raised position
- No tractor oil leaks
- Radiator free of debris
- Engine oil level and condition
- Engine coolant level and condition
- Power brake fluid level
- Power steering fluid level
- Fuel condition and level
- Sufficient lubrication at all lube points
- Air filter condition OPS-U-0030



# OPERATION

## 6.2 Boom Unit Pre-Operation Inspection and Service

Inspect and service the boom arm and head prior to operation. Damaged and/or broken parts should be repaired and/or replaced immediately. To ensure the unit is ready for operation, conduct the following:

OPS-B- 0020



All Safety Shields, Guards and Safety devices including (but not limited to) - the Deflectors, Steel Guards, Gearbox Shields, PTO integral shields , and Retractable Door Shields should be used and maintained in good working condition. All safety devices should be inspected carefully at least daily for missing or broken components. Missing, broken, or worn items must be replaced at once to reduce the possibility of injury or death from thrown objects, entanglement, or blade contact. (SFL-5)

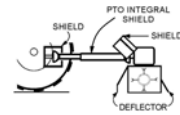

Replace bent or broken blades with new blades. NEVER ATTEMPT TO STRAIGHTEN, WELD, OR WELD HARDFACING ON BLADES SINCE THIS WILL LIKELY CRACK OR OTHERWISE DAMAGE THE BLADE WITH SUBSEQUENT FAILURE AND POSSIBLY CAUSE SERIOUS INJURY FROM THROWN BLADES. (SGM-10)

The operator's manual and safety signs affixed on the unit contain important instructions on the safe and proper use of the equipment. Maintain these important safety features on the implement in good condition to ensure the information is available to the operator at all times.

- Ensure the manual canister is secured to the equipment with the operator's manual inside.
- Ensure all safety signs are in place and legible. Replace missing, damaged, and illegible decals. OPS-U- 0011



**NOTE:** The mower Operator's Manual and affixed Decals contain important instructions on the safe and proper use of the mower. Maintain these important safety features on the mower in good condition to ensure the information is available to the operator at all times.



KEEP AWAY FROM ROTATING ELEMENTS to prevent entanglement and possible serious injury or death. (SG-24)



# OPERATION

## FRAME ASSEMBLY

- Ensure all bolts and screws are in position and are properly torqued.
- Ensure all pins are in place and fastened with screws.
- Ensure frame is properly mounted to tractor and hardware is properly installed and tightened. *OPS-B- 0021\_H*



## BOOM ARM ASSEMBLY

- Inspect condition of each arm section weldment
- Ensure all pins are in place.
- Ensure all bolts and screws are properly installed.
- Check condition of teflon bushings at boom pivot points.
- Ensure each hydraulic cylinder is installed and retained correctly. Ensure the proper size pins are used to retain the cylinders in place and are secured properly.
- Ensure that all joints are lubricated. See Maintenance Section for Lubrication Chart. *OPS-B-0022\_K*



### **WARNING**

Never attempt to lubricate, adjust, or remove material from the Implement while it is in motion or while tractor engine is running. (SG-20)

## HYDRAULIC LINE INSPECTION

- Check for hydraulic leaks along hoses, cylinders and fittings. **IMPORTANT:** DO NOT use your hands to check for oil leaks. Use a piece of heavy paper or cardboard to check for hydraulic oil leaks.
- Inspect the condition of the valve weldment.
- Ensure fitting is properly connected
- Inspect condition of nylon bushings. *OPS-B- 0023\_J*



# OPERATION

## **WARNING**

Relieve hydraulic pressure prior to doing any maintenance or repair work on the Implement. Place the Mower Head on the ground or securely supported on blocks or stands, disengage the PTO, and turn off the engine. Push and pull the control Levers or Joystick several times to relieve pressure prior to starting any maintenance or repair work. (SBM-6)

## **WARNING**

Never Leave the mower unattended while the head is in the raised position. The mower could fall causing serious injury to anyone who might inadvertently be under the mower. (SBM-4)



## **WARNING**

Do not operate this Equipment with hydraulic oil or fuel leaking. Oil and fuel are explosive and their presence could present a hazard. Do not check for leaks with your hand! High-pressure oil streams from breaks in the line could penetrate the skin and cause tissue damage including gangrene. To check for a hose leak, SHUT the unit ENGINE OFF and remove all hydraulic pressure. Wear oil impenetrable gloves, safety glasses and use Cardboard to check for evidence of oil leaks. If you suspect a leak, REMOVE the HOSE and have it tested at a Dealer. If oil does penetrate the skin, have the injury treated immediately by a physician knowledgeable and skilled in this procedure. (SG-15)



### HYDRAULIC PUMP/OIL RESERVOIR

- Check oil reservoir level and oil condition. (Add specific type oil if low)
- Change hydraulic oil filter and hydraulic oil according to maintenance schedule.
- Ensure there are no oil leaks and fitting are properly connected
- Inspect overall condition of hydraulic pump.
- Inspect pump drive shaft.



Check the fluid level in the Hydraulic Tank on the Tractor, and add oil if required. As the air has been forced out of the Cylinders and Hoses, it goes into the Hydraulic Tank and reduces the volume of oil. Maintain the oil level within the sight gauge located on the side of the reservoir. Never fill the tank above the sight gauge to allow for the expansion of the oil. The tank maintains pressure after the mower has been run. Stand off to one side when removing the breather cap element to prevent possible injury. To relieve pressure remove the breather cap element and depress the spring loaded pressure valve to release any excess air. OPS-B- 0024\_H

# OPERATION

## **WARNING**

Attention: Oil Filler Cap is also the Pressure Relief Cap.

Remove cap slowly to relieve pressure before removing cap completely. Stay clear to prevent being scalded with hot oil that may spray out of the tank that is still pressurized and may cause serious injury to eyes, face, and exposed skin. (Ops-0001-MISC)

## **WARNING**

Avoid contact with hot surfaces including hydraulic oil tanks, pumps, motors, valves and hose connections. Relieve hydraulic pressure before performing maintenance or repairs. Use gloves and eye protection when servicing hot components. Contact with a hot surface or fluid can cause serious injury from burns or scalding. (SG-34)

## **WARNING**

Do not operate this Equipment with hydraulic oil or fuel leaking. Oil and fuel are explosive and their presence could present a hazard. Do not check for leaks with your hand! High-pressure oil streams from breaks in the line could penetrate the skin and cause tissue damage including gangrene. To check for a hose leak, SHUT the unit ENGINE OFF and remove all hydraulic pressure. Wear oil impenetrable gloves, safety glasses and use Cardboard to check for evidence of oil leaks. If you suspect a leak, REMOVE the HOSE and have it tested at a Dealer. If oil does penetrate the skin, have the injury treated immediately by a physician knowledgeable and skilled in this procedure. (SG-15)



OPERATION

## FLAIL HEAD INSPECTION

- Inspect blades and blade bolts for looseness and excessive wear. Rotate to 90° to make for checking easier. Replace damaged, worn, and missing blades as complete sets to maintain cuttershaft balance.
- Ensure rubber deflectors are in position and not damaged. Replace worn, broken, and missing sections immediately.
- Ensure the rollers are in good condition and rotate freely.
- Inspect that all bolts and screws are in position and are properly torqued.
- Ensure hydraulic lines are properly connected to the hydraulic motor. Check for hydraulic leaks along hoses and fittings. DO NOT use your hands to check for oil leaks. Use a piece of heavy paper or cardboard to check for hydraulic oil leaks.
- Remove any grass or other debris which may be wrapped around the cuttershafts ends.
- Inspect the condition of deck skid shoes and hardware. OPS-B- 0026\_C

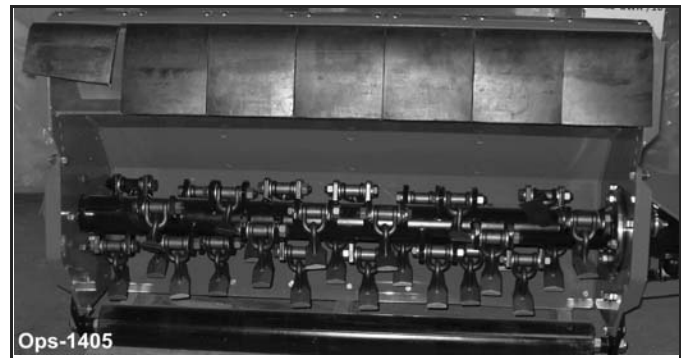

# OPERATION

## SICKLE BAR INSPECTION

- Inspect blades and blade bolts for looseness and excessive wear. Replace damaged, worn, and missing blades.
- Ensure guards are in position and not damaged. Replace worn, broken, and missing guards.
- Inspect that all bolts and screws are in position and are properly torqued.
- Ensure hydraulic lines are properly connected to the hydraulic valve and cylinders. Check for hydraulic leaks along hoses and fittings. DO NOT use your hands to check for oil leaks. Use a piece of heavy paper or cardboard to check for hydraulic oil leaks.
- Ensure hydraulic cylinder is installed and retained correctly. Ensure the proper size pins are used to retain the cylinder in place and are secured with pins.
- Remove any grass or other debris which may be wrapped around the cutterbar. OPS-B- 0063

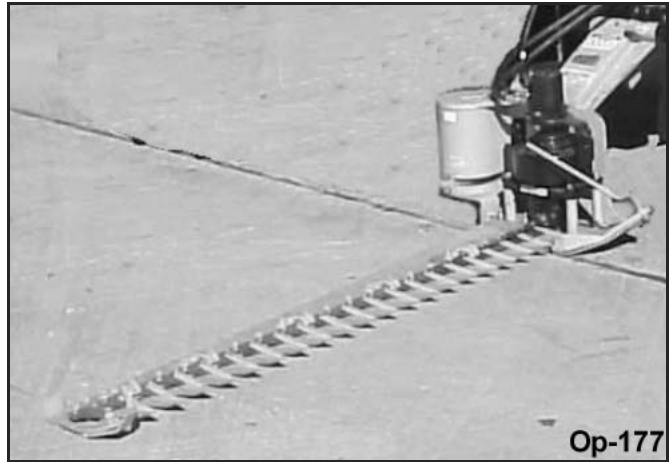

### **WARNING**

Do not operate this Equipment with hydraulic oil or fuel leaking. Oil and fuel are explosive and their presence could present a hazard. Do not check for leaks with your hand! High-pressure oil streams from breaks in the line could penetrate the skin and cause tissue damage including gangrene. To check for a hose leak, SHUT the unit ENGINE OFF and remove all hydraulic pressure. Wear oil impenetrable gloves, safety glasses and use Cardboard to check for evidence of oil leaks. If you suspect a leak, REMOVE the HOSE and have it tested at a Dealer. If oil does penetrate the skin, have the injury treated immediately by a physician knowledgeable and skilled in this procedure. (SG-15)



### **WARNING**

Do not put hands or feet near the cutter bar. Blade contact can result in serious injury. Stay away until all motion has stopped and the mower is securely blocked up. (SSM-1)

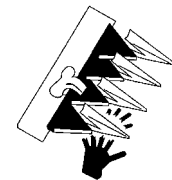



# OPERATION

## Tractor PRE-OPERATION Inspection



Mower ID# \_\_\_\_\_ Make \_\_\_\_\_

Date: \_\_\_\_\_ Shift \_\_\_\_\_



**Before conducting the inspection, make sure the tractor engine is off, all rotation has stopped and the tractor is in park with the parking brake engaged. Make sure the mower is resting on the ground or securely blocked up and all hydraulic pressure has been relieved.**

**OPERATION**

Item	Condition at Start of Shift	Specific Comments if not O.K.
The flashing lights function properly		
The SMV Sign is clean and visible		
The tires are in good condition with proper pressure		
The wheel lug bolts are tight		
The tractor brakes are in good condition		
The steering linkage is in good condition		
There are no visible oil leaks		
The hydraulic controls function properly		
The ROPS or ROBS Cab is in good condition		
The seatbelt is in place and in good condition		
The 3-point hitch is in good condition		
The drawbar pins are securely in place		
The PTO master shield is in place		
The engine oil level is full		
The brake fluid level is full		
The power steering fluid level is full		
The fuel level is adequate		
The engine coolant fluid level is full		
The radiator is free of debris		
The air filter is in good condition		

Operator's Signature: \_\_\_\_\_

**DO NOT OPERATE an UNSAFE TRACTOR or MOWER**

This Inspection Form may be freely duplicated for extra copies.

# OPERATION

## Boom Mower PRE-OPERATION Inspection



Mower ID# \_\_\_\_\_ Make \_\_\_\_\_

Date: \_\_\_\_\_ Shift \_\_\_\_\_



**Before conducting the inspection, make sure the tractor engine is off, all rotation has stopped and the tractor is in park with the parking brake engaged. Make sure the mower is resting on the ground or securely blocked up and all hydraulic pressure has been relieved.**

**OPERATION**

Item	Condition at Start of Shift	Specific Comments if not O.K.
The Operator's Manual is in the canister on the mower		
All safety decals are in place and legible		
The Mounting frame bolts are in place and tight		
The Boom connection bolts & pins are tight		
There are no cracks in boom		
The Hydraulic Cylinders pins are tight		
The Hydraulic Pump hose connections are tight		
The Hydraulic Valve hose connections are tight		
The Hydraulic Valve controls function properly		
There are no leaking or damaged hoses		
The Hydraulic Oil level is full		
There is no evidence of Hydraulic leaks		
The Blades are not chipped, cracked or bent		
The Blade bolts are tight		
The Deflectors are in place and in good condition		
The Mower shields are in place and in good condition		
The Skid shoes are in good condition & tight		
There are no cracks or holes in mower deck		
The Hyd. motor mounting bolts are tight		
The mower head spindle housing is tight and lubricated		

Operator's Signature: \_\_\_\_\_

**DO NOT OPERATE an UNSAFE TRACTOR or MOWER**

# OPERATION

## 7. MACHINE CONTROLS

### 7.1 Cable Controls - Identification & Function

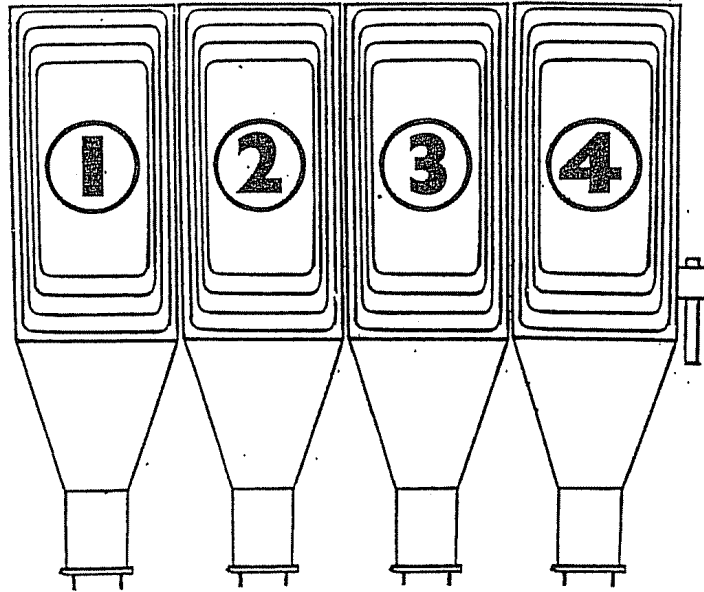

Ops-1567

OPERATION

# OPERATION

OPERATION

## 7.2 Lever Functions

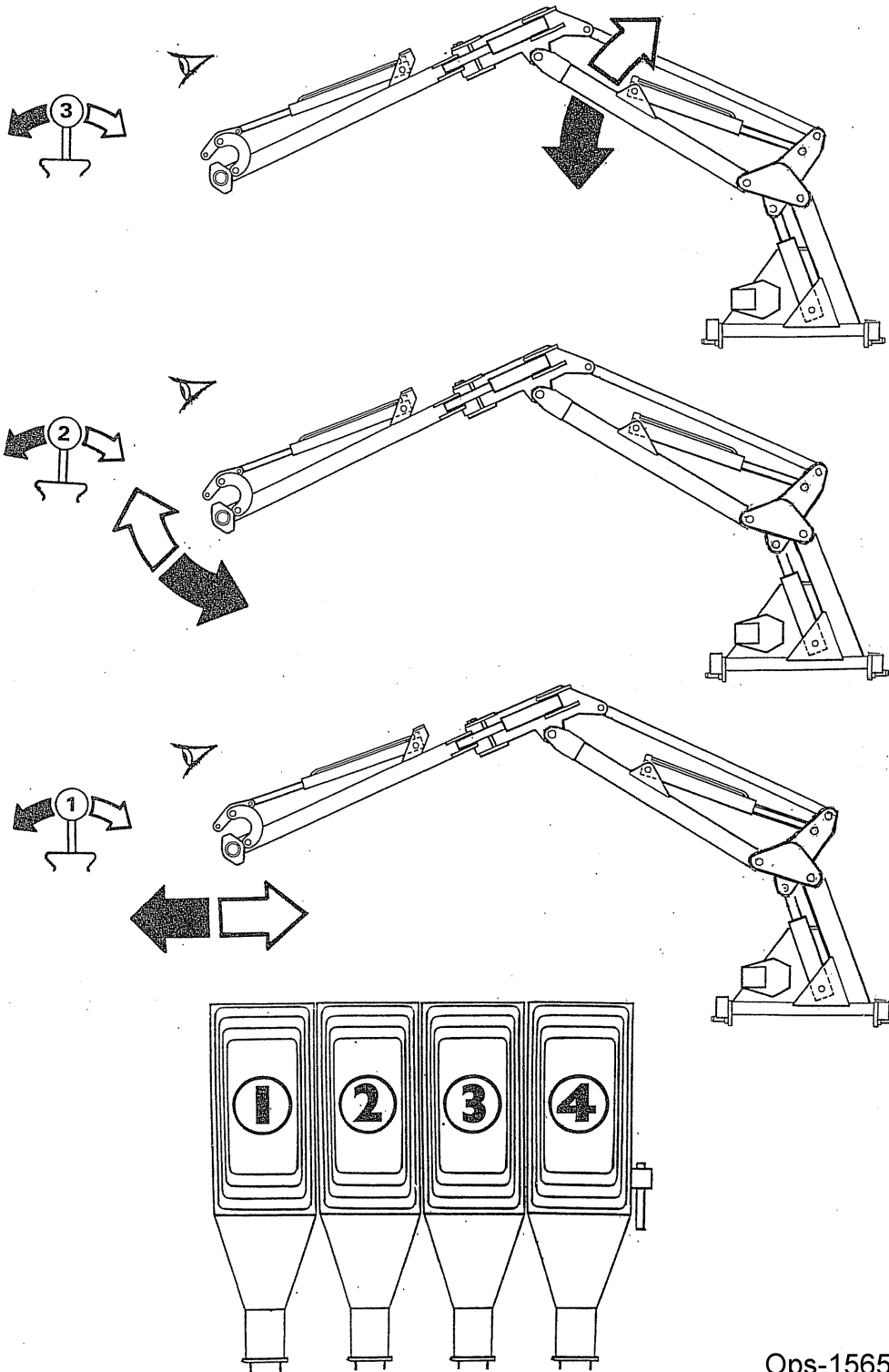

Ops-1565

# OPERATION

## 7.3 Rotor Control - Ti Machines only

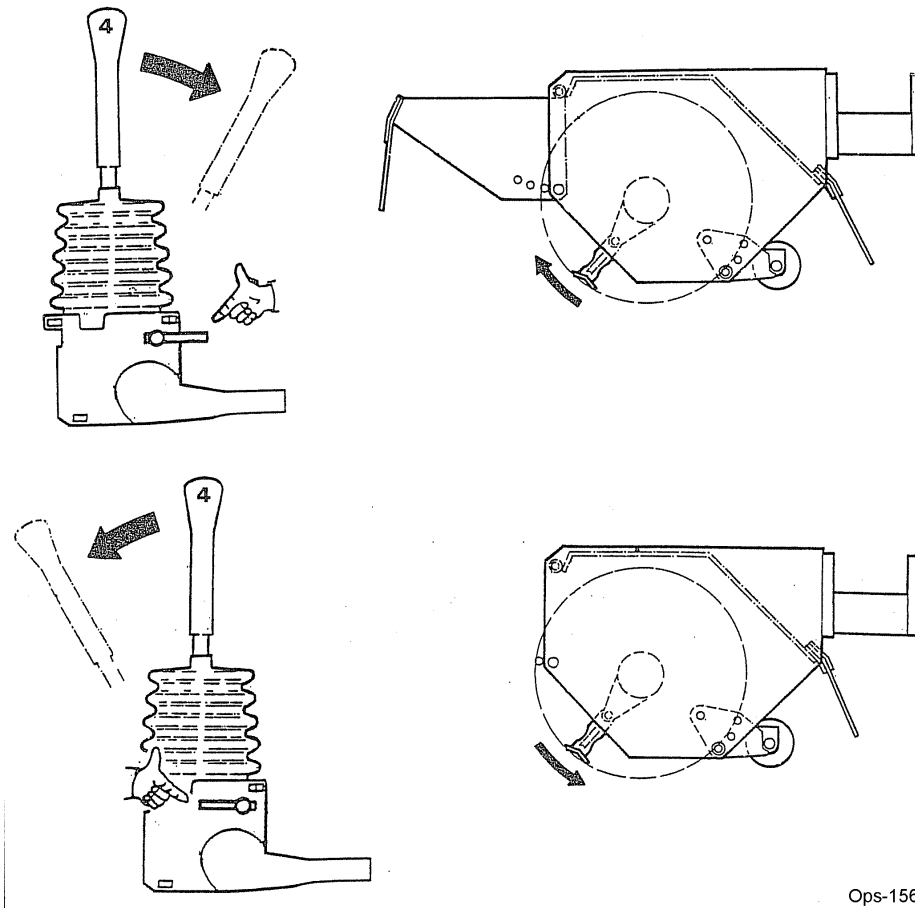

Ops-1566

### **Reversing Rotation Ti Machine - PA41 with Flailhead**

Select "Rotor OFF".

Wait until the rotor has stopped turning.

Turn the small lever on the side of the rotor control lever pivot box through 180 degrees. This will reset the control lever stop inside the pivot box and allow opposite rotation to be selected.

### **Reversing Rotation - PA41 with cutterbar**

Always pull the lever towards the operator to start cutterbar operation.

Never reverse cutting direction.

### **Reversing Rotation Si Machines - PA41 with Flailhead**

The flail hose connections on the junction bracket at the lower end of the dipper arm must be interchanged.

**NOTE:** If machine is converted to cutter bar configuration, check hose connections to cutter bar motor carefully as the wrong connections could damage the knife drive.

### **PA41 with cutterbar**

Never reverse cutting direction.

# OPERATION

OPERATION

## 8. ENGAGING DRIVE

### Ti Models Only

Ensure that the rotor control lever is in the "STOP" position before engaging the PTO shaft. Allow the oil to circulate for a minute or so before operating the armhead levers. Position the flail head in a safe position, increase the engine speed to a high idle and move rotor control lever to "START". After initial surging the rotor will run at an even speed.

### Si Models Only

On cutterbar models ensure that the motor hoses are connected correctly.

Place the cutter head at a safe attitude and bring the tractor engine revolutions to 1000 RPM. Engage the PTO and slowly increase revolutions until operating speeds are attained.

## 9. OPERATING SPEED

**NOTE:** For cutterbars 500 RPM is a guide speed only. It should be run only as fast as necessary to do the job. Never exceed 540 RPM PTO speed.

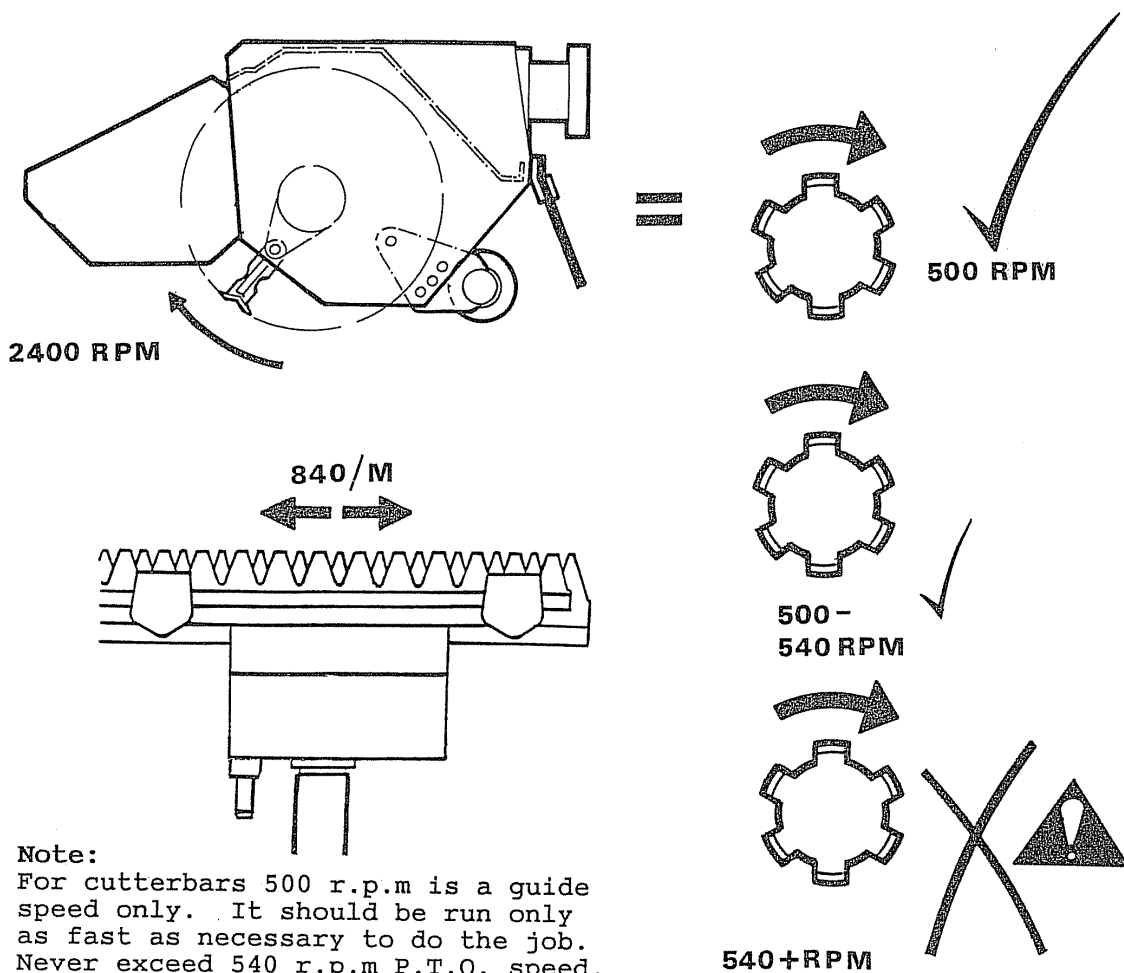

**Note:**

For cutterbars 500 r.p.m is a guide speed only. It should be run only as fast as necessary to do the job. Never exceed 540 r.p.m P.T.O. speed.

Ops-1568

# OPERATION

## 10. FORWARD SPEED



Op-531

The material being cut determines tractor forward speed. Forward speed can be as fast as that which allows the flail head sufficient time to cut the vegetation properly.

Too fast a speed will be indicated by over frequent operation of the breakaway system, a fall off in tractor engine revs and a poor finish to the work leaving ragged uncut tufts and poorly mulched cuttings.

## 11. PARALLEL MOTION GEOMETRY

This feature enables the operator to adjust the reach of the machine in and out without having to continuously adjust the lift service to compensate for the change in head pivot height as is the case with traditional geometries.

**NOTE:** The performance of the feature is at its most accurate during the mid-range of the reach travel with some deterioration in performance being experienced when the outer extremities of reach adjustment are approached.

## 12. BREAKAWAY

The machine is fitted with a hydraulic breakaway device which protects the structure of the machine should an unforeseen obstacle be encountered.

**NOTE:** The breakaway function does not relieve the operator of his responsibility to drive carefully, be alert and AVOID OBVIOUS HAZARDS BEFORE CONTACT OCCURS.

The pivoted arm is held and in line by the oil pressure in the fully extended breakaway ram. When the flail head meets an obstruction and the tractor continues to move forward, oil pressure will build up, against a relief valve situated in the base of the breakaway ram. When the preset pressure is reached, the valve will blow and the oil will be vented into the lift ram. This will allow the flail head to pivot backwards and at the same time cause the arms to rise. When the obstruction is cleared, oil pressure contained in the lift ram will cause the arm and flail head to return to the work position.

Breakaway may occur momentarily during normal work should an extra thick or dense patch of vegetation be encountered. In these instances tractor forward motion may be maintained with care. Where breakaway has occurred as a result of contacting a post or tree etc. the tractor must be halted and the controls of the machine utilized to maneuver the head away from the obstacle. NEVER CONTINUE FORWARD MOTION TO DRAG THE HEAD AROUND THE OBSTACLE IN BREAKBACK POSITION.

**NOTE:** The force required to activate the breakaway system will vary dependent upon the gradient of work. It will require less force when working uphill and vice versa.

# OPERATION

## 13. ANGLE FLOAT

The selection of angle float on the control box simultaneously connects both gland and base side of the angling ram to tank.

The ram rod can then extend and retract freely allowing the flail head to automatically follow the contours of the ground.

Angle float is an “operator friendly” mowing feature and can be used singly or in conjunction with lift float.

**NOTE:** For the feature to work its maximum capabilities, the head must be mounted such that it is balanced around the pivot.

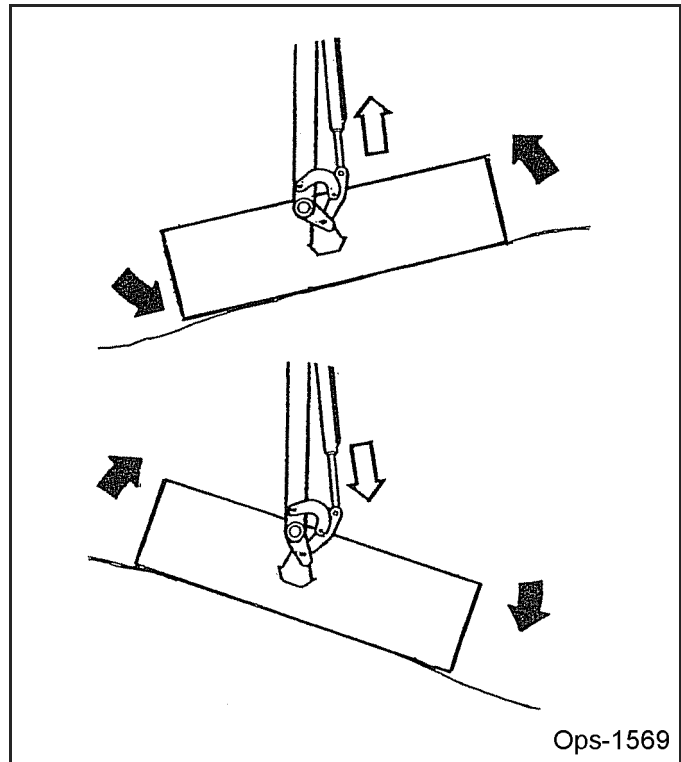

## 14. High Voltage Cables

### **WARNING**

Depending on the voltage of the cables and the weather conditions there is a danger of electric flashover if the head or arms approach the cables too closely.

ALWAYS MAINTAIN A MINIMUM CLEARANCE DISTANCE OF 10 FEET WHEN OPERATING NEAR HIGH VOLTAGE CABLES.

If in any doubt consult your local electric company regarding a safe procedure for work.

**OVERHEAD OBSTRUCTIONS** Always be aware that the machine is approximately 13 ft. high when folded - take care when maneuvering in areas with overhead obstacles especially power cables, low bridges etc. or when entering buildings.

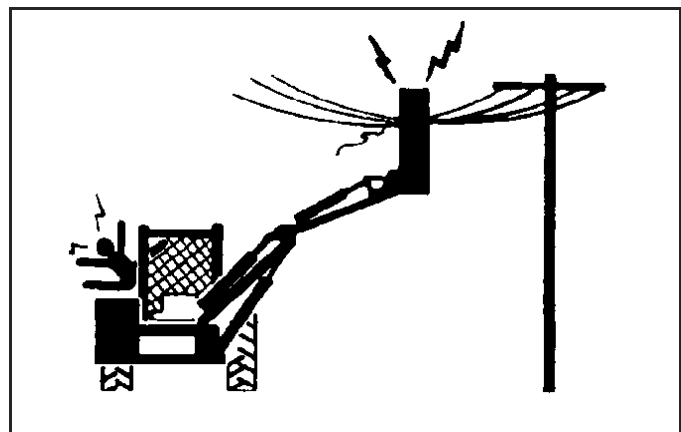



# OPERATION

## 15. Hedge Cutting Procedure

Cut the side and bottom of the field side first. This leaves the maximum thickness of hedge on the road side to prevent the possibility of any debris being thrown through the hedge into the path of oncoming vehicles.

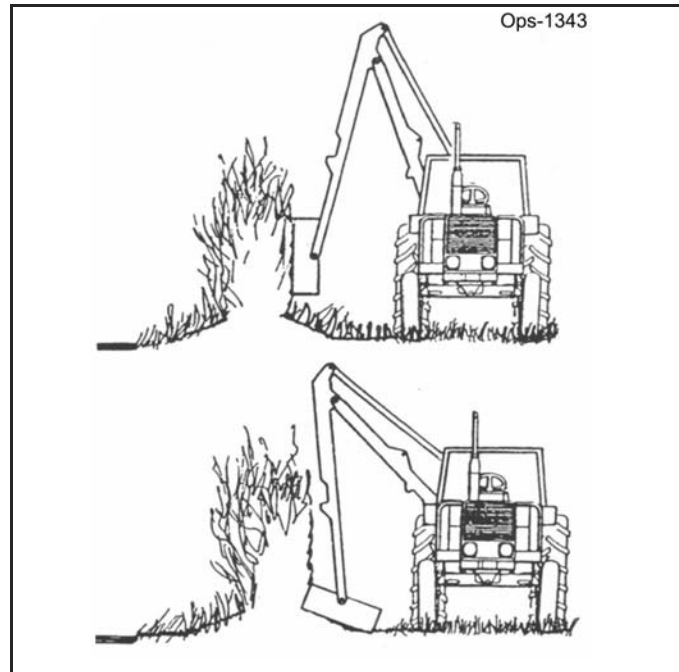

Cut the side and bottom of the road side.

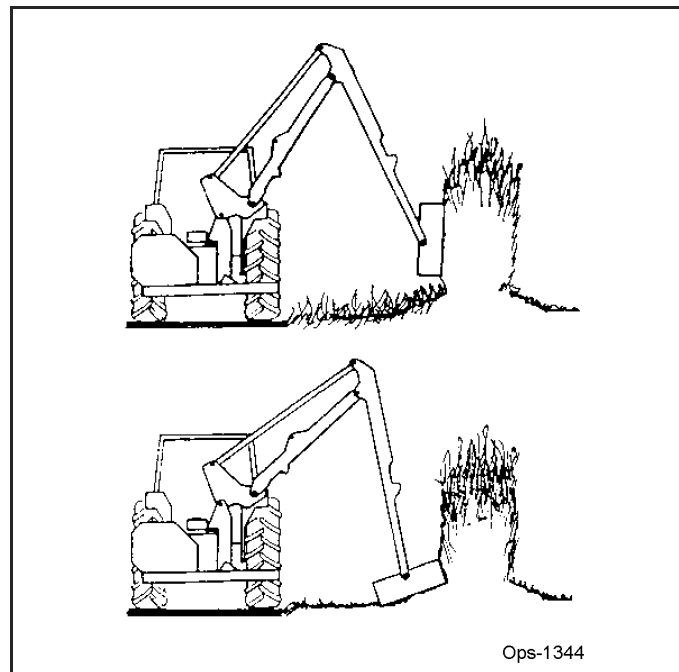

# OPERATION

Top cut the hedge to the height required.

**NOTE:** Never cut over the far side of the hedge. It is impossible to see any potential hazards and the position of the flail head will allow the possibility of debris being thrown through the hedge towards the tractor and operator.

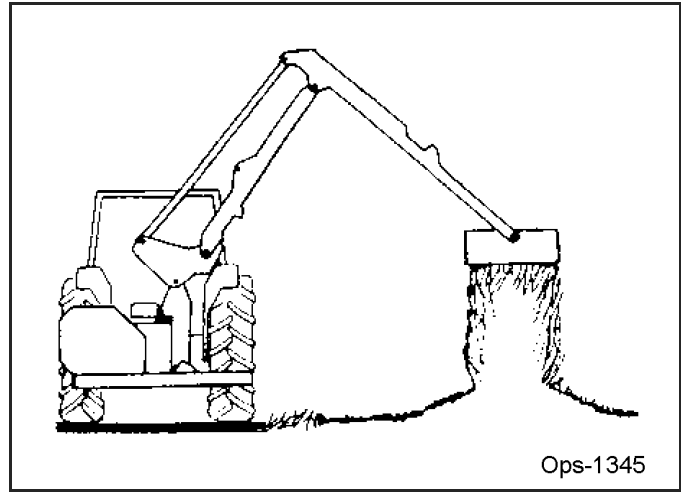

## 15.1 Working on Adverse Slopes

When working high with the reach fully extended, it is possible for the main arm balance to go 'Over-Center' and take the weight off the lift cylinder. A restrictor in the gland connection of the lift ram prevents sudden unpredictable movements should this occur.

**NOTE:** Always inspect the work area prior to cutting to remove hazardous material and note any immovable objects.

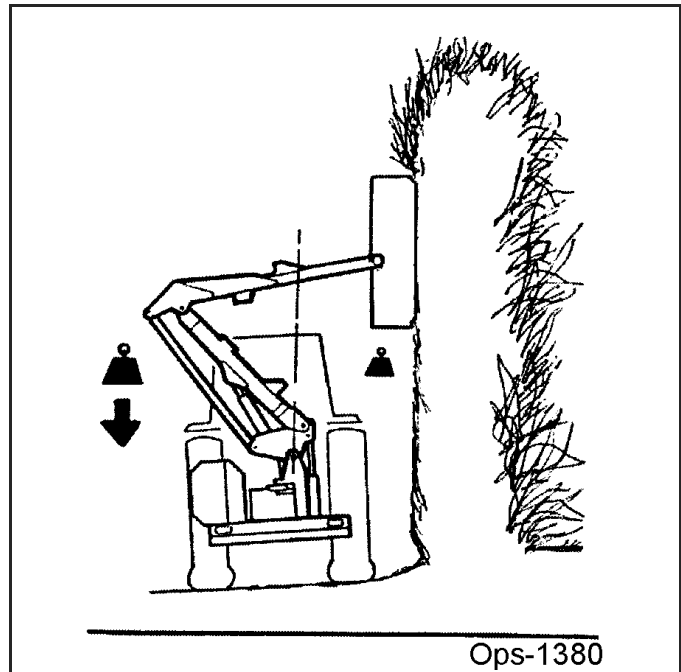

# OPERATION

## **16. Lift Float Kit (Optional)**

### **Optional Extra for ground cutting on flail machines.**

The hydraulic float kit, if fitted, should be mounted as shown (**Figure Ops-1570**), bolted to the tank stay strap.

In working with the poppet valve, open the flail head will automatically follow the ground contours.

The float action is engaged by manually lifting the knurled plunger on top of the poppet valve out of the V groove and rotating through 90 degrees.

The lift control should be operated to take a proportion of the flail head weight off the flail roller. This is important, too little weight on the roller will leave uncut areas of grass while with too much weight on the roller the ground will be scalped in places and increased flail wear, damage or even loss of flails could occur.

To revert to standard operation, the accumulator is isolated from the lift ram by returning the knurled plunger to the "OFF" position.

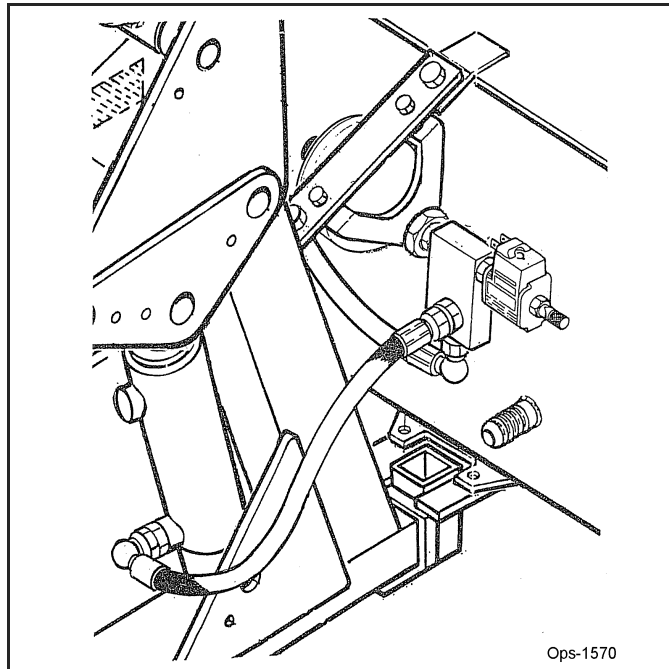

## **17. DRIVING THE TRACTOR AND IMPLEMENT**

Safe tractor transport requires the operator to possess a thorough knowledge of the model being operated and precautions to take while driving with an attached implement. Ensure the tractor has the capacity to handle the weight of the boom and the tractor operating controls are set for safe transport. To ensure safety while driving the tractor with a boom, review the following.

Read all safety instructions. Decals on the Boom warn you of particular and multiple hazards. Some decals are attached close to part of the Boom where there is a possible hazard. Read and make sure you understand the safety messages before you operate the implement. Keep all decals clean and readable. Replace lost or damaged decals, refer to safety section for more information.

Power for operating the mower is supplied from the tractor PTO. Refer to your tractor manual instructions for engaging and disengaging the PTO. Start the tractor and bring the engine speed up to normal operating 540 PTO speed. Always engage the PTO at low engine RPM and run the mower for a short period until all air is removed from the hoses. Keep all person's well clear of mower since blades can throw objects with great velocity for a considerable distance! KEEP CLEAR! OPS-B- 0005

# OPERATION

**⚠ DANGER**

Never operate the Tractor or Implement until you have read and completely understand this Manual, the Tractor Operator's Manual, and each of the Safety Messages found in the Manual or on the Tractor and Implement. Learn how to stop the tractor engine suddenly in an emergency. Never allow inexperienced or untrained personnel to operate the Tractor or Implement without supervision. Make sure the operator has fully read and understood the manuals prior to operation. (SG-4)

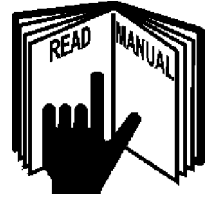

**⚠ WARNING**

Always maintain the safety signs in good readable condition. If the safety signs are missing, damaged, or unreadable, obtain and install replacement safety signs immediately. (SG-5)

**⚠ DANGER**

This Implement may be wider than the Tractor. Be careful when operating or transporting this equipment to prevent the Implement from running into or striking sign posts, guard rails, concrete abutments or other solid objects. Such an impact could cause the Implement and Tractor to pivot violently resulting in loss of steering control, serious injury, or even death. Never allow the Implement to contact obstacles. (S3PT-12)

**⚠ DANGER**

BEFORE leaving the tractor seat lower the implement, set the parking brake and/or set the tractor transmission in parking gear, disengage the PTO, stop the engine, remove the key, and wait for all moving parts to stop. Place the tractor shift lever into a low range or parking gear to prevent the tractor from rolling. Never dismount a Tractor that is moving or while the engine is running. Operate the Tractor controls from the tractor seat only. (SG-9)

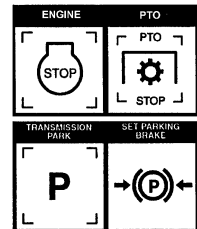

## 17.1 Starting the Tractor

The procedure to start the tractor is model specific. Refer to the tractor operator's manual for starting procedures for your particular tractor. Consult an authorized dealer if the starting procedure is unclear. Ensure the 3-point control lever is in the lowered position and the PTO is disengaged before starting the tractor. OPS-U-0033



# OPERATION

## **17.2 Brake and Differential Lock Setting**

Make sure the tractor brakes are in good operating condition. Tractor brakes can be set to operate independently allowing single rear wheel braking action or locked together to provide simultaneous rear wheel braking. **FOR MOST DRIVING AND OPERATING CONDITIONS, THE BRAKE PEDALS SHOULD BE LOCKED TOGETHER TO PROVIDE THE MOST EFFECTIVE BRAKING ACTION.**

Always disengage the tractor differential lock when turning. When engaged the differential lock will prevent or limit the tractor from turning. During normal cutting conditions, locking the differential provides no benefit and should not be used. *OPS-U-0013*



### **▲WARNING**

Be aware of the operating conditions. Do not operate the Tractor with weak or faulty brakes. When operating down a hill or on wet or rain slick roads, the braking distance increases; use extreme care and reduce your speed in these conditions. When operating in traffic, always use the Tractor's flashing warning lights and reduce your speed. Be aware of traffic around you and watch out for the other guy.

# OPERATION

## 17.3 Driving the Tractor and Boom

Start off driving at a slow speed and gradually increase your speed while maintaining complete control of the tractor. Never operate the tractor at speeds that cannot be safely handled or which will prevent the operator from stopping quickly during an emergency. If the power steering or engine ceases operating, stop the tractor immediately as the tractor will be difficult to control.

Perform turns with the tractor and mower at slow speeds to determine how the tractor with and attached implement handles a turn. Determine the safe speed to maintain proper control of the tractor when making turns. When turning with the implement the overall working length and width of the unit is increased. Allow additional clearance for the unit when turning or when passing large obstructions.



To avoid overturns, drive the tractor with care and at safe speeds, especially when operating over rough ground, crossing ditches or slopes, and turning corners. Use extreme caution when operating on steep slopes. Keep the tractor in a low gear when going downhill. DO NOT coast or free-wheel downhill.

OPS-B- 0006



Never Leave the mower unattended while the head is in the raised position. The mower could fall causing serious injury to anyone who might inadvertently be under the mower. (SBM-4)



Always keep a careful lookout and use extreme care when working around overhead obstructions. Never allow the Mower head or boom within 10 feet of any power line. When working close to overhead power lines consult your electric company for a safe code of operation. (SBM-7)

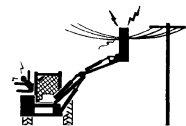

# OPERATION

## **18. OPERATING THE TRACTOR AND IMPLEMENT**

**THE OPERATOR MUST COMPLETELY UNDERSTAND HOW TO OPERATE THE TRACTOR AND IMPLEMENT AND ALL CONTROLS BEFORE ATTEMPTING TO OPERATE.** The operator must read and understand the Safety and Operation Sections of the implement and tractor operator's manuals. These manuals must be read and explained to any operator who cannot read. Never allow someone to operate the implement and tractor without complete operating instructions.

Before starting any operation, the operator must become familiar with the area to be worked in and any obstacles and hazards contained within to ensure safety to the operator, bystanders, and equipment. Special attention should be paid to foreign debris, rough terrain, steep slopes, and passersby and animals in the area.  
*OPS-U- 0015*

### **18.1 Foreign Debris Hazards**

Before mowing, inspect the area to make sure there are no foreign objects that the mower blades could hit or become entangled with. Remove all foreign objects and debris. If objects are too big to remove, mark them clearly and be sure to prevent the mower blades from contacting them.

If you hit a solid object or foreign debris, stop the mower and tractor at once. Immediately idle the engine speed and disengage the PTO. Wait for all mower rotating motion to stop, then raise the mower and move the tractor and implement off the object. Inspect the area and remove, or mark the location of the debris. Inspect the condition of the mower and make any needed repairs immediately. Make sure the blades are not damaged and the carrier is balanced before resuming operation.

Always wear your seat belt securely fastened and only operate the tractor and mower with the ROPS in the raised position. If the tractor or mower hits a tree stump, rock, or bump, a sudden movement could throw you off of the seat and under the tractor and/or mower. The seat belt is your best protection from falling off the tractor and the ROPS provides protection from being crushed during a tractor roll-over. *OPS-F-0010*



# OPERATION

## 18.2 Bystanders/Passersby Precautions

If a bystander comes within 300 feet of the tractor while the mower is being operated, stop the tractor at once, idle the engine and disengage the PTO. Do not engage the PTO again until all bystanders are well past the 300 foot distance. OPS-R-0024



Flail Mowers are capable under adverse conditions of throwing objects for great distances (300 feet or more) and causing serious injury or death. Follow safety messages carefully.



STOP MOWING IF PASSERSBY ARE WITHIN 300 FEET UNLESS:

- Front and Rear Deflectors, Chain Guards, or Bands are installed and in good, workable condition;
- Mower sections or Wings are running close to and parallel to the ground without exposed Blades;
- All areas have been thoroughly inspected and all foreign material such as rocks, cans, glass, and general debris has been removed.

**NOTE:** *Where there are grass and weeds high enough to hide debris that could be struck by the blades, the area should be: inspected and large debris removed, mowed at an intermediate height, inspected closely with any remaining debris being removed, and mowed again at desired final height. (This will also reduce power required to mow, reduce wear and tear on the Mower drivetrain, spread cut material better, eliminate streaking, and make the final cut more uniform.)* (SFL-6)

## 18.3 Engaging the Power Take Off (PTO)

Before engaging the PTO, make certain that the area is clear of bystanders and passersby. The implement must be completely lowered and the deck positioned at a safe operating height. NEVER engage the PTO with the implement in the raised position.

Set the tractor engine speed at approximately 1,000 RPM before engaging the PTO. Shift the PTO control to the on position, and slowly increase the engine speed until the PTO is operating at the rated speed. If you hear unusual noises or see or feel abnormal vibrations, disengage the PTO immediately. Inspect the implement to determine the cause of the noise or vibration and repair the abnormality. OPS-U- 0027



Do not put hands or feet under mower decks. Blade Contact can result in serious injury or even death. Stay away until all motion has stopped and the decks are securely blocked up. (SGM-09)





# OPERATION

## **18.4 Operating Speed and Ground Speed**

Ground speed for mowing will depend upon the height, type, and density of vegetation to be cut. Do Not exceed 2 MPH while operating. Operate the mower at its full rated PTO speed to maintain blade speed for a clean cut. Refer to the tractor operator's manual or the tractor instrument panel for the engine speed and gear to provide the required operating and desired ground speed. Make sure that the mower is operating at its full rated speed before entering the vegetation to be cut. Always start and stop cutting blades with engine near idle.

Ground speed is achieved by transmission gear selection and not by the engine operating speed. The operator may be required to experiment with several gear range combinations to determine the best gear and range which provides the most ideal performance from the implement and most efficient tractor operation. As the severity of cutting conditions increase, the ground speed should be decreased by selecting a lower gear to maintain the proper operating PTO speed. *OPS-B-0009*



Do not exceed the rated PTO speed for the Implement. Excessive PTO speeds can cause Implement driveline or blade failures resulting in serious injury or death. (SG-26)



Mow at the speed that you can safely operate and control the tractor and mower. The correct mowing speed depends on terrain condition and grass type, density, and height of cut. Normal ground speed range is from 2 to 5 mph(3-8 kph). Use slow mowing speeds when operating on or near steep slopes, ditches, drop-offs, overhead obstructions, power lines, or when debris and foreign objects are to be avoided. (SGM-07)

## **18.5 Operating the Mower**

Only operate the mower from the tractor operator's seat with the seatbelt securely fastened. The tractor must be equipped with a ROPS in the raised position or a ROPS cab.

The mower is designed to cut vegetation up to 1" in diameter. Sharp blades will produce a cleaner cut and require less power. Travel at a speed that allows the mower sufficient time to cut through the vegetation and maintain the PTO operating speed to prevent overloading the mower and tractor. Choose a driving pattern that provides the maximum pass length and minimizes turning.

Under certain conditions, tractor tires may roll some grasses down preventing them from being cut at the same height as the surrounding area. When this occurs, reduce the tractor ground speed while maintaining the operating speed of the mower. A slower ground speed will permit grasses to at least partially rebound and be cut. Taking a partial cut and/or reversing the direction of travel may also help produce a cleaner cut.

Avoid mowing in the reverse direction when possible. In situations where the mower must be backed to access areas to be cut, make sure there are no persons or other foreign debris behind the mower before mowing in reverse. When mowing in reverse, operate the tractor and mower at a reduced ground speed to ensure tractor and mower control is maintained. *OPS-R-0026\_G*

# OPERATION

**⚠ DANGER**

There are obvious and hidden potential hazards in the operation of this Mower. REMEMBER! This machine is often operated in heavy brush and in heavy weeds. The Blades of this Mower can throw objects if shields are not properly installed and maintained. Serious injury or even death may occur unless care is taken to insure the safety of the operator, bystanders, or passersby in the area. Do not operate this machine with anyone in the immediate area. Stop mowing if anyone is within 300 feet of mower. (SGM-02)



**⚠ WARNING**

Do not mow with two machines in the same area except with Cab tractors with the windows closed. (SGM-11)

**⚠ WARNING**

Mow only in conditions where you have clear visibility in daylight or with adequate artificial lighting. Never mow in darkness or foggy conditions where you cannot clearly see at least 300 feet (90 m) in front and to the sides of the tractor and mower. Make sure that you can clearly see and identify passersby, steep slopes, ditches, drop-offs, overhead obstructions, power lines, debris and foreign objects. If you are unable to clearly see these type of items discontinue mowing. (SGM-1)

**⚠ WARNING**

Avoid mowing in reverse direction when possible. Check to make sure there are no persons behind the mower and use extreme care when maneuvering in reverse. Mow only at a slow ground speed where you can safely operate and control the tractor and mower. Never mow an area that you have not inspected and removed debris or foreign material. (SGM-08)

**⚠ WARNING**

Follow these guidelines to reduce the risk of equipment and grass fires while operating, servicing, and repairing the Mower and Tractor:



- Equip the Tractor with a fire extinguisher in an accesible location.
- Do Not operate the Mower on a Tractor with an underframe exhaust.
- Do Not smoke or have an open flame near the Mower and Tractor.
- Do Not drive into burning debris or freshly burnt areas.
- Ensure slip clutches are properly adjusted to prevent excessive slippage and plate heating.
- Never allow clippings or debris to collect near drivelines, slip clutches, and gearboxes. Periodically shut down the Tractor and Mower and clean clippings and collected debris from the mower deck. (SGM-12)

## **18.6 Operating the Attached Mower Heads**

Refer to the Assembly Section of this manual to ensure the head is properly attached to the boom hitch and hydraulic lines are properly connected.

# OPERATION

## **⚠ DANGER**

There are obvious and hidden potential hazards in the operation of this Mower. REMEMBER! This machine is often operated in heavy brush and in heavy weeds. The Blades of this Mower can throw objects if shields are not properly installed and maintained. Serious injury or even death may occur unless care is taken to insure the safety of the operator, bystanders, or passersby in the area. Do not operate this machine with anyone in the immediate area. Stop mowing if anyone is within 300 feet of mower. (SGM-02)



## **Grass Flail**

- The Grass Flail head is rated for cutting grass and small brush up to 1-1/2".
- The Grass Flail operates attached to the boom arm, and is ideal for cutting hard to reach areas where a smooth cut is required.
- Cutting height ranges from 3/4" to 4" in vegetation. Cutting height is set by adjusting the height of the roller assembly.
- When operating near the ground or when mulching be particularly careful that there are no bystanders or animals within a 300 feet. Debris tends to fly out at great speed and can injure or even cause death. OPS-B- 0040\_B

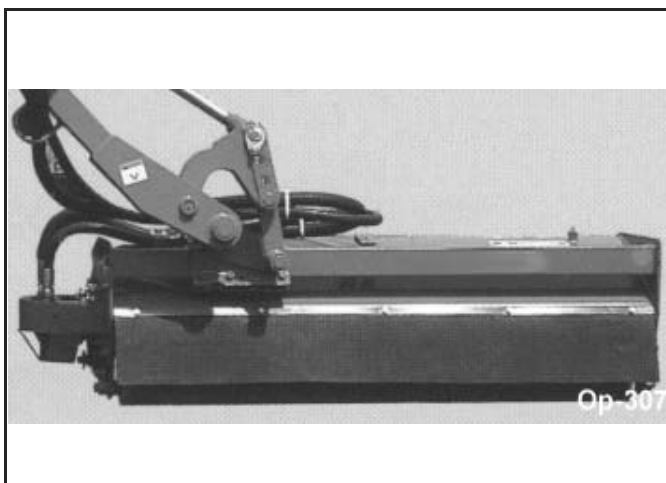

## **Sickle Bar**

- The Sickle Bar Cutter will cut a 5' swath through tough weeds and grass.
- The Sickle Bar Cutter is operated attached to the boom arm and is ideal for vegetation maintenance
- When operating the Sickle Bar correctly it will give you a fast, efficient, and cost-effective method of vegetation maintenance.
- The Sickle Bar will also cut vegetation through tough weeds under water, ideal for maintaining ponds, creeks, and other areas that may be under shallow water.
- When operating the unit be sure there are no bystanders or animals within 300 feet of the unit. OPS-B- 0049

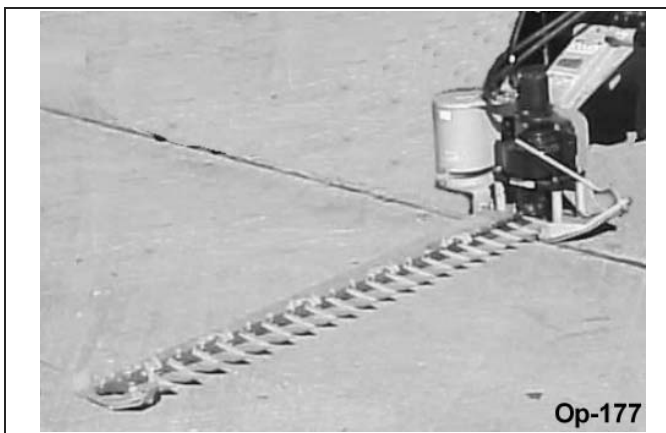

# OPERATION

OPERATION

## 18.7 Shutting Down the Attached Head

To shut down attached mower head, first bring the tractor to a complete stop. Decrease engine RPM to idle then disengage cutterhead. The mower head will come to a complete stop within a suitable amount of time. Do not engage or disengage the cutterheads at a high RPM unless there is an emergency situation.

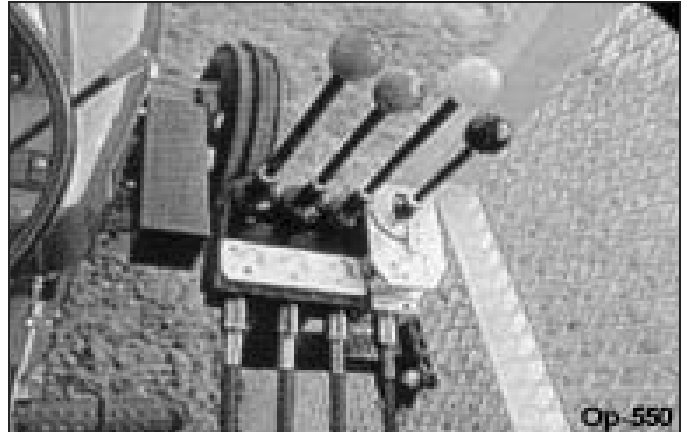

Park the tractor on a level surface, place the transmission in park or neutral and apply the parking brake, shut down the engine, remove the key, and wait for all motion to come to a complete stop before exiting the tractor. OPS-B- 0011\_G



**DANGER**

BEFORE leaving the tractor seat lower the implement, set the parking brake and/or set the tractor transmission in parking gear, disengage the PTO, stop the engine, remove the key, and wait for all moving parts to stop. Place the tractor shift lever into a low range or parking gear to prevent the tractor from rolling. Never dismount a Tractor that is moving or while the engine is running. Operate the Tractor controls from the tractor seat only. (SG-9)

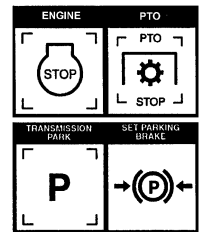

**DANGER**

Always shut the Tractor completely down, place the transmission in park, and set the parking brake before you or anyone else attempts to connect or disconnect the Implement and Tractor hitches. (S3PT-15)

**DANGER**

Never allow children or other persons to ride on the Tractor or Implement. Falling off can result in serious injury or death. (SG-10)



# OPERATION

## 19. TRACTOR, BOOM, AND ATTACHED HEAD STORAGE

Properly preparing and storing the unit at the end of the season is critical to maintaining its appearance and to help ensure years of dependable service. The following are suggested storage procedures:

- Thoroughly clean all debris from boom and head to prevent damage from rotting grass and standing water.
- Lubricate all grease points and fill oil levels according to the maintenance lubrication schedule.
- Tighten all bolts to the proper torque. Ensure all pins and other hardware are in place.
- Check the boom arm and head for worn and damaged parts. Perform repairs and make replacements so that the mower will be ready for use at the start of the next season.
- Store the unit in a clean and dry location.
- Use spray touch-up enamel where necessary on bare metal surfaces to prevent rust and to maintain the appearance of the mower.

*OPS-B- 0012\_G*



## 20. TRANSPORTING THE TRACTOR AND IMPLEMENT

Inherent hazards of operating the tractor and implement and the possibility of accidents are not left behind when you finish working in an area. Therefore, the operator must employ good judgement and safe operation practices when transporting the tractor and implement between locations. By using good judgement and following safe transport procedures, the possibility of accidents while moving between locations can be substantially minimized. *OPS-U- 0017*



Never allow children or other persons to ride on the Tractor or Implement. Falling off can result in serious injury or death. (SG-10)



# OPERATION

## 20.1 Transport Position

For transport on public highway, the flail must be folded within the overall width of the tractor.

### **PA41 with Flail head**

Position the arm until the head is approximately 4 feet clear of the ground and the dipper is horizontal.

Pull the dipper arm to the rear to remove tension on the breakaway ram base pin and remove it.

Manually break back the dipper until the base of the ram is relocated between the inboard holes in the ram lugs. Replace the ram base pin.

Select "Lift up" until the main arm is as high as it can go without projecting beyond the tractor's width. Fully select "Reach In". Select "Angle down" to turn the flails towards the tractor.

For off road transport where width is not critical, it will be sufficient to fully fold the arms.

### **PA41 with Cutterbar**

With cutterbar horizontal and with tractor switched off, fit knife guard. Remember to keep fingers away from the knife as it can move even with the tractor engine switched off.

Select "Lift up" until the main arm is as high as it can go without projecting beyond the tractor's width. Fully select "Reach in". Fully select "Angle up".

To revert to "Work" mode, the above procedures must be reversed.

## 20.2 TRANSPORT POSITION - Head Attached

The machine is transported in line to the rear of the tractor with a minimum of 11-1/4" clearance between the tension link and the rear cross member of the tractor cab.

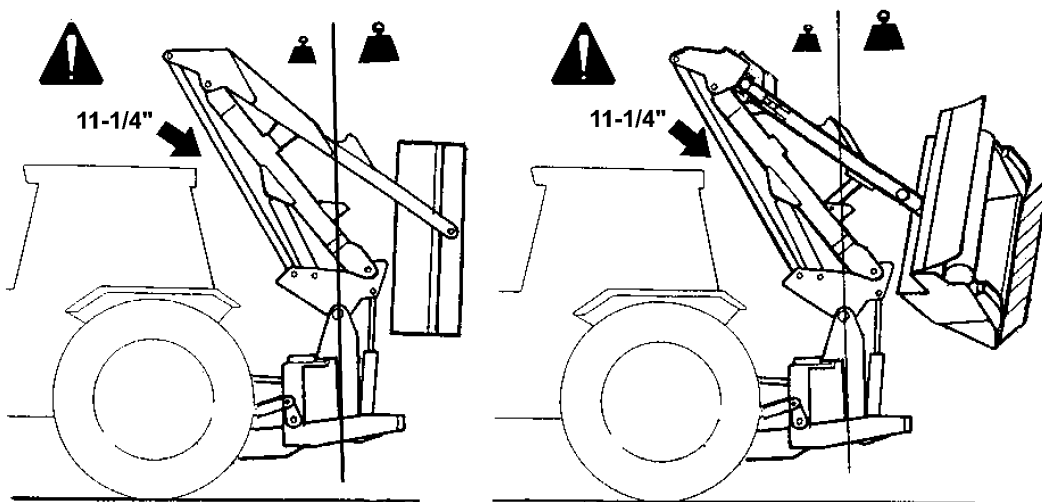

Ops-1359

# OPERATION

## 20.3 TRANSPORT POSITION - Head Removal

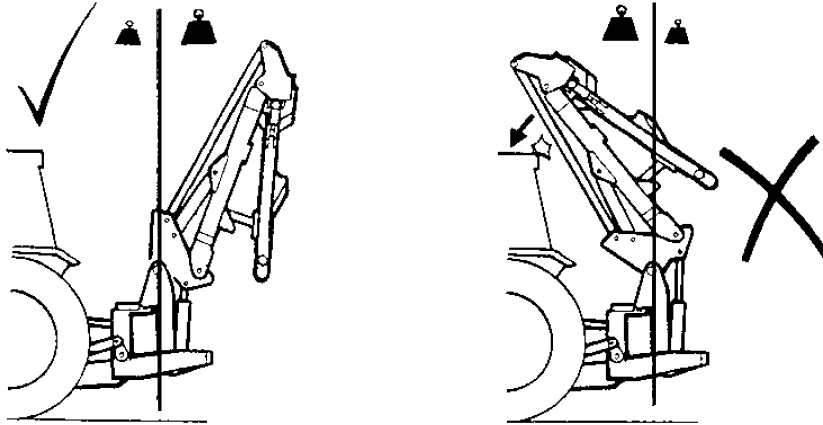

Ops-1360

With the flail head removed the arms are fully folded but the lift ram remains retracted. If the lift ram is extended the weight of the arms will cause the balance of the machine to go over center causing the tension link to crash into the rear cross member of the tractors cab.



During transport the 'SLEW' mode must ALWAYS be selected on the control assembly.

## 20.4 Transport Height

There is no fixed dimension for transport height. It will vary depending on the height that the machine is carried and the degree of arm fold that the rear of the cab will allow.

For the majority of installations the transport height will generally fall between a minimum of 3.45m (11'1/2") and a maximum of 3.65m (12') when the machine is correctly folded.

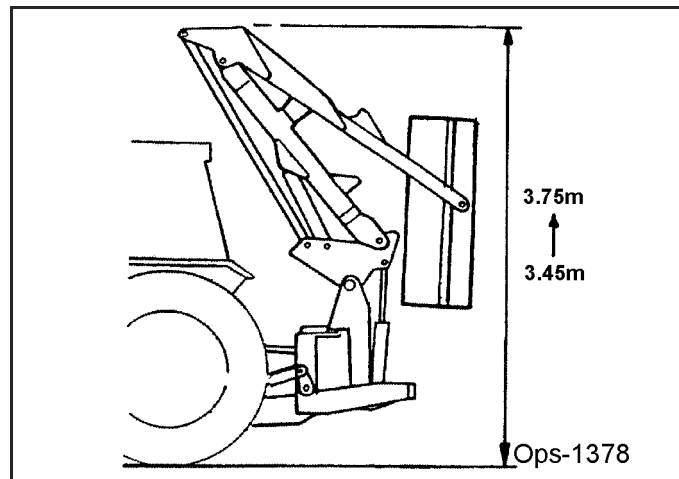

Ops-1378

# OPERATION

Before transporting the tractor on a public roadway or boarding a trailer for transport, the tractor brake pedals should be locked together. Locking the pedals ensures that both wheels brake simultaneously while stopping, especially when making an emergency stop.

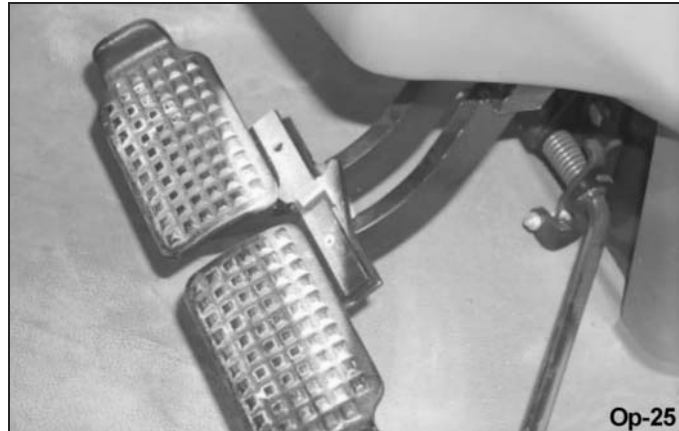

Use extreme caution and avoid hard applications of the tractor brakes when towing heavy loads at road speeds. Never tow the implement at speeds greater than 20 MPH (32 kph). OPS-U- 0018

## 20.5 Transporting on Public Roadways

Extreme caution should be used when transporting the tractor and implement on public roadways. The tractor must be equipped with all required safety warning features including a SMV emblem and flashing warning lights to alert drivers of the tractor's presence. Remember that roadways are primarily designed for automotive drivers and most drivers will not be looking out for you, therefore, you must look out for them. Check your side view mirrors frequently and remember that vehicles will approach quickly because of the tractor's slower speed. Be extremely cautious when the piece of equipment that you are towing is wider than the tractor tire width and/or extends beyond your lane of the road.

Make sure that a proper size safety tow chain is secured between the tractor and implement before entering a public road. OPS-U- 0019

**NOTE:** Ensure that the mower sections are fully raised and that the transport locks are engaged for each section.



Never allow children or other persons to ride on the Tractor or Implement. Falling off can result in serious injury or death. (SG-10)



Make certain that the "Slow Moving Vehicle" (SMV) sign is installed in such a way as to be clearly visible and legible. When transporting the Equipment use the Tractor flashing warning lights and follow all local traffic regulations. (SG-6)

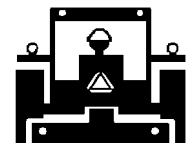



# OPERATION

The SMV (Slow-Moving Vehicle) emblem is universal symbol used to alert drivers of the presence of equipment traveling on roadways at a slow speed. SMV signs are a triangular bright orange with reflective red trim for both easy day and night visibility. Make sure the SMV sign is clean and visible from the rear of the unit before transporting the tractor and implement on a public roadway. Replace the SMV emblem if faded, damaged, or no longer reflective. *OPS-U-0020*



Make sure that all tractor flashing warning lights, headlights, and brake/taillights are functioning properly before proceeding onto public roads. While newer model tractors have plenty of lighting to provide warning signals and operating lighting, most older models were only equipped with operating lights. Consult an authorized tractor dealer for lighting kits and modifications available to upgrade the lighting on older tractor models. *OPS-B-0015*



When operating on public roads, have consideration for other road users. Pull to the side of the road occasionally to allow all following traffic to pass. Do not exceed the legal speed limit set in your state or municipality for agricultural tractors. Always stay alert when transporting the tractor and mower on public roads. Especially in busy cities, the boom extends to right farther than the tractor's width, so be careful there are no bystanders, poles, large obstructions or any vehicles that may be in path of the mower head or boom. Use caution and reduce speed if other vehicles or pedestrians are in the area. *OPS-B-0016*



# OPERATION

Reduce speed before turning or applying the brakes. Ensure that both brake pedals are locked together when operating on public roads. OPS-U- 0023



**DANGER**

When transporting Boom Mower on a truck or trailer, the height or width may exceed legal limits when the boom is in the transport position. Contact with side or overhead structures or power lines can cause property damage or serious injury or death. If necessary lower boom to reduce height and/or remove mowing head to reduce width to the legal limits. (SBM-8)

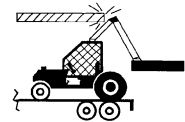

## 20.6 Hauling the Tractor and Implement

Before transporting a loaded tractor and implement, measure the height and width dimensions and gross weight of the complete loaded unit. Ensure that the load will be in compliance with the legal limits set for the areas that will be traveled through. OPS-U- 0024\_TK



# OPERATION

Use adequately sized and rated trailers and equipment to transport the tractor and implement. Consult an authorized dealer to determine the proper equipment required. Using adequately sized chains, heavy duty straps, cables and/or binders, securely tie down both the front and rear of the tractor utilizing the proper tie down locations as specified by the tractor manufacturer. OPS-U- 0025



Arrange the chains so that when tightened, the chains are pulling downward and against themselves. Carefully tighten the securing chains or other fasteners using boomers or binders to apply maximum tension. Use extreme care when attaching and removing the securing devices as the extreme tension involved when released has the potential to inflict serious injury.



While hauling the tractor and implement, make occasional stops to check that the tractor and implement have not moved or shifted and that the securing chains have maintained tension. If during transport a hard braking, sharp turning, or swerving action was performed, stop at the next safe location to inspect the security of the load.

**NOTE:** Always transport per you state law regulations for tie down requirements. OPS-U- 0026\_TK

# OPERATION

## 21.TROUBLESHOOTING GUIDE

<b>Problem</b>	<b>Possible Cause</b>	<b>Remedy</b>
<b>Boom Breaks Back Too Easily</b>	Work Port Relief Malfunction or Failure	Test to confirm, Adjust or Replace as needed
	Swing Cylinder Failure	Test to Confirm, Rebuild or replace as needed
	Cutting head "Plowing" in Ground	Operator Error, Operator Training
<b>Boom Drops When Two Functions Actuated</b>	Operator Travelling Too Fast	Operator Error, Operator Training
	Low Oil Level on Boom Function System	Fill oil and bleed system of air
	Failed One way Flow Restrictor in valve	(Gravity Aided Functions Only) Confirm and replace
<b>Boom Moves on Its Own (Under Power w/ no function actuated) Electronic Joystick Models</b>	Defective or damaged Controller	Repair or Replace as needed
	Incorrect Hose Size to Cylinder(s)	Replace with proper OEM part
	Defective or Damaged Joystick Controller	Repair or Replace as required.
	Improper adjustment of Joystick potentiometer gear timing	Adjust to locate proper neutral setting per the Service Manual
	Solenoid Valves stuck due to contamination	Repair or replace as required. Flush and fill Hydraulic System
	Failed O-ring on Solenoid Valves	Replace the O-ring with proper replacement parts
	C.A.N. System Improperly Adjusted	Consult a Factory Trained Service Technician to facilitate the proper adjustment of the system
<b>Boom Moves on Its Own (Under Power w/ no function actuated) Mechanical Joysticks with Cables</b>	Valve Main Spool Bent or Stuck	Replace the Valve Section
	Improper Wiring	Confirm and Repair
	Defective or Damaged Control Module(s)	Replace the module(s)
	Defective or Damaged Joystick	Repair or replace as required
	Cables Sticking	
	Bent too sharply	Install new cable and route to provide adequate bend radius
	Overheated due to contact with hydraulic components	Replace Cables and insulate from Hydraulic Components
	Connection at valve damaged or failed	Repair or replace as required
	Main Spool in Valve Stuck or bent	Repair or replace as required

# OPERATION

<b>Problem</b>	<b>Possible Cause</b>	<b>Remedy</b>
<b>Cylinder Excessive Drift</b>	May be normal Operation	Check Allowable Drift rates in Service Manual
	Cylinder Piston Seals Bypass	Test to confirm and repair or replace
	Damaged or Defective Work Port Relief Valves	Check Relief Pressures. Repair or replace as required
	Main Valve Spool Leakage	Confirm with tests, Repair or replace as required
	Oil Contamination	May be root cause of any internal Leakage. Test oil and replace as required. review the previous section
<b>Cylinder Leaks at Fittings</b>	Related to Issues described in Previous section: Boom moves under its own power	
	Loose Fittings	Check for cracks and retighten
<b>Cylinder Leaks at Rod</b>	Wrong Fittings Installed	Replace with Correct fittings
	<b>Damaged or defective fitting (cracked)</b>	<b>due to over tightening, replace hose or fitting</b>
	Fitting Port cracked	Repair or replace Cylinder or port
<b>Cylinder Moves Wrong Way (Not the function that was actuated)</b>	Faulty Seals on Cylinder Gland	Disassemble and Replace
	Damaged Cylinder Rods	Clean or Replace the Rod as required.
	Cylinder Rods Bent	Determine Cause of Overload. Replace the Rod
<b>Cylinder Moves Wrong Way (Not the function that was actuated)</b>	Incorrect Hose Routing	Check Hose Diagram in the Service Manual and route the hoses correctly
	Wire Harness improperly Installed	Confirm incorrect placement and Re attach the harness connectors as needed.
	Operator Perception of Correct Operation is incorrect	Consult the Operator's Manual for Correct operation and communicate with the Operator.
<b>Cylinder Moves intermittent (all functions)</b>		
	Cylinder Control Pump Failure (all functions affected)	Test pump to confirm. Rebuild or replace as required.
	Load Sense Signal Not reaching the pump	Check valve Pilot pressure and Load sense check valves.
	Low Or Improper Oil in Hydraulic system	Replace or fill as required.
	Contamination of Oil causing restricted flow in the valve.	Replace oil, and clean components.
	No voltage to Joystick Controller	Check Fuses, wires etc and repair as required
Faulty Joystick Controller	Test then replace or repair as required.	

# OPERATION

## Problem

**Cylinder Moves Spongy or Jerky**

## Possible Cause

Air in oil

## Remedy

Identify the source of the Air. Replace Oil if Required, or cycle the mower several times to purge the oil

Wrong Oil Used

Check Specifications for proper oil, and replace

Oil is cold

System must be warmed to at least 40degrees F for proper operation.

Faulty Pump or Pump drive

Check or test then replace or repair as required.

Workport reliefs set too low

Test relief pressure and replace with proper Work port relief valve.

**Cylinder Moves Some Functions (But Not All)**

Faulty Joystick Controller

Test the joystick and repair or replace as required

Oil Level too low

Fill the hydraulic tank as required

Faulty Solenoid valve

Test and repair or replace as required

Contamination in valve

Flush system and clean the valve as required

Faulty main spool or valve section

Replace the valve section

Bad Control Module

Replace the module

Incorrect Hose Routing

Check for proper hose routing in the Service manual and correctly install

Incorrect Work port Relief installed

Check work port relief pressure and replace as needed

Work Port relief failure

Test work port relief pressure and replace if required

Cylinder Failure

test cylinder, repair or replace as needed

One way Flow restrictor installed in wrong port, or backwards

Check proper installation in Service Manual. One way flow restrictors are required on most Gravity aided functions and both directions of the swing functions

Pump Worn out

test to confirm, repair or replace as required

Air in oil

Locate the source of the air and repair. Flush and fill oil as required

Engine RPM too slow

rated rpm is 540 PTO speed as indicated on the tachometer

**Cylinder Rod Bent**

Operator Abuse

Operator training, Travel speed too fast, or impact with solid objects while mowing

Misalignment of Cylinder Lugs (bent boom)

Operator abuse, Excessive loading of boom components

Work Port Relief improper setting or failure

Check for proper setting. Replace as needed

Interference with another component

Operator abuse or components interfering with boom movement

# OPERATION

<b>Problem</b>	<b>Possible Cause</b>	<b>Remedy</b>
<b>Cylinder Rod Came Out of Cylinder</b>	Piston Nut backed off of the Rod	Improper retaining of nut, replace or rebuild as required
	Relief Valve setting Too High	Test relief valve and adjust or replace as required
	Operator abuse	Overloading cylinder in the extend position
<b>Deck Cracks</b>	Severe Use or Abuse	Excessive ground speed, Overload or impact with solid objects
	Vibration	Blades or blade bar bent, or blade missing
	Poor or missing welds	Manufacturing defect
<b>Deck Worn On Underside (Cutting Head Only)</b>	Mowing over sand or rocks	Operator abuse
	Abusive operation, mowing heavy debris	Operator abuse
	Normal operational wear	Normal wear over time can result in cracks or damage. Check deflectors and guards. Replace as required.
<b>Hydraulic System Noise (Squeal)</b>	Restrictions to oil flow in the system	Identified by concentration of heat, due to Line restriction bent hoses or contamination.
	Relief Valve Malfunction	Relief setting too low, will result in generation of heat, Adjust or replace as needed.
	Cavitation	induction of air into the system due to leakage
<b>Hydraulic System Overheating</b>	Wrong Oil Used	Flush and refill as required
	Excessive Engine RPM	Engine RPM should not exceed 540 PTO speed as indicated on the tractor tachometer
	Restriction in Hydraulic System	Identified by a concentration of heat due to crimped hydraulic line, relief valve failure or contamination.
	Relief Valve Set too low	Test and adjust or replace as required
	Internal Leakage due to wear	Test pump and motor. Replace or repair as required
	Excessive Pump or Motor Wear	Test pump and motor. Replace or repair as required
	Wrong Oil	Flush and refill as required with proper oil
<b>Motor Flange or Motor Housing Breaking</b>	Abusive Operation (Heavy Material or debris)	Operator abuse
	Excessive Torque load due to abuse	Impact with solid objects or excessive loading of mower due to high ground speed.
	Loss of Bolt torque at flange or at motor section	Due to excessive loading. Check bolts daily, and replace or repair as required

# OPERATION

<b>Problem</b>	<b>Possible Cause</b>	<b>Remedy</b>
<b>Motor Inoperative (Won't Run)</b>	Low Oil level or No Oil	Fill or replace as required
	Improper Oil Used	flush and replace the oil
	Solenoid valve Failure or O-ring Failure at the Solenoid Valve	Remove the solenoid valve and inspect. Replace as required
	No voltage to Solenoid Valve	Check harness connections, fuses and wires
<b>Motor Overheating</b>	Incorrect Wiring at Solenoid valve	Wrong plug installed (Maverick and Machete). Timbercat harness plug used in place of Other mower plug. Reconnect with proper plug
	Spindle Locked up	Check by spinning blades. See Section on spindle failures
	Oil Level Too Low	Fill or replace as required
	Incorrect Oil Used	Flush and fill as required
	Air in Oil	Locate the source and repair. Flush and fill the oil as required
	Engine RPM too high	Tractor must be operated at the 540PTO speed as indicated on the tachometer
	Excessive ground speed for mowing conditions	Operator abuse
	Excessive ground contact with blades	Operator abuse
<b>Motor Shaft Seal Leaking</b>	Internal leakage in pump or motor	Test to confirm. Repair or replace as required
	Relief valve malfunction	Test relief valve setting. Adjust or replace as required
	Restrictions in the system	Identified by concentration of heat, due to Line restriction bent hoses or contamination.
	Excessive Back Pressure on return side of the motor.	Due to bent fittings or crimped hoses. Inspect the system and repair as required
	Incorrect oil used	Replace with correct oil.. Flush and fill
	Shaft Seal worn	Due to heat from the spindle or failure of spindle components. Check spindle section
	Failed Seal Retainer	Manufacturing defect. Consult customer service for proper repair or replacement
Defective Motor Flange casting	Manufacturing defect. Consult customer service for proper repair or replacement	



# OPERATION

## Problem

**Motor Runs Too Slow  
(or Slows Down Under  
Load)**

**Motor Stops (Stops  
under Load)**

## Possible Cause

Engine RPM too slow

Pump Drive Damaged  
Logic Valve O-ring Failure  
(Gear Systems)

Damaged O-ring on  
Solenoid Valve

Pump Worn or Defective  
Motor Damaged or  
defective

Incorrect Oil in System

Air in the oil

Excessive Ground Speed  
for Mowing Conditions

Excessive Internal  
Leakage in pump/motor  
Low Relief Valve Setting

Restrictions in the system

**Pump Seizure (Pump  
Locks Up)**

**Pump Wear (Rapid  
Excessive Wear)**

Lack of Oil

Inadequate or lack of pump  
Prime during initial start up.

Improper assembly

Contamination

Defective Pump

## Remedy

Tractor must be operated at the 540PTO speed as indicated on the tachometer

Check drive shaft attachment to the tractor  
Remove logic valves and inspect seals.  
Replace as required

Remove solenoid valve. Replace seals as required.

Test to confirm, Repair or replace as required  
Confirm Pump is Working correctly, Check that spindle is not locking up, Replace or repair the motor as required

Flush and fill with proper oil per the specifications

Locate the source of the air intake and fix.  
Flush and fill the oil as required

Operator Abuse

Confirm with pressure/flow test and replace or repair as required

Check the Setting using a pressure/flow meter with a restrictor valve. Adjust or replace as needed

Identified by a concentration of heat due to crimped hydraulic line, relief valve failure or contamination.

Repair or replace the pump or motor. Fill the oil to the correct level and check for leaks

Pumps must be properly primed prior to initial startup. Consult the Technical Service manual or contact Customer Service for proper procedures

Pump may have been reassembled incorrectly by the dealer following a prior failure. Rebuild or replace

Contaminants in the system will damage the components. Repair or replace the affected components, then flush and refill with clean oil. Inspect the tank for debris.

Confirm defect with customer service and replace

# OPERATION

## OPERATION

<b>Problem</b>	<b>Possible Cause</b>	<b>Remedy</b>
<b>Spindle Leaking At Motor</b>	Due to Motor Seal Failure (hydraulic Oil leak)	See section on motor seal failure and repair as needed
	Motor Loose or bolts missing	Bolts should be checked every 8 hrs. Loss of torque will result in seal failure and leakage
	Gasket torn due to movement of motor on spindle flange	See above
<b>Spindle Leaking Around Bottom Seal</b>	Excessive Backpressure in Spindle	Remove the Spindle vent plug and check for clogs or contamination.
	Seal Damaged due to Debris	Replace as required. Check for damaged or missing seal guard
<b>Spindle Leaking At Relief Vent</b>	Bearings Loose	Disassemble the Spindle and inspect the bearings for damage. Re-assemble and properly pre-load the bearings based on the technical service manual.
	Seal blown out due to excessive back pressure	Remove the Spindle vent plug and check for clogs or contamination.
	Relief fitting installed in the fill hole (wrong hole)	Install the vent in the top most hole or even with the top of the top bearing race. The lower hole is the fill hole and should have a grease zerk or plug installed.
<b>Spindle Overheating</b>	Spindle Overfilled	Overfilling will result in the lubricating oil being expelled from the vent.
	Low Grease Level in the spindle	Fill lubricant until it can be seen in the top most (vent plug) hole.
	Excessive Bearing Pre-load	Disassemble the spindle and inspect the bearings for wear. Re-assemble following the bearing pre-load specifications in the Technical Service Manual.
<b>Spindle Shaft Loose or Falls Out</b>	Blade bar bolts are too long	Installing the incorrect bolts (too long) for the blade carrier will allow the bolts to contact the lower bearing and will lock up the spindle. Install the correct bolts.
	Bearing Pre-load adjusting nut and/or lock nut failure	Locking washers are provided to retain the pre-load lock nut in place. Improper installation of the washer and locking mechanism will allow the lock nuts to back off. Re-assemble following the recommended procedures
<b>Spindle Shaft Loose or Falls Out</b>	Bearing cups or cones not installed properly	Disassemble and check for wear. Follow reassembly procedures indicated in the Technical Service Manual
	Severe upper bearing failure.	Usually due to lack of lube. Replace the bearing(s) and make sure the spindle is properly filled. Also check for leakage and repair as needed.

# OPERATION

<b>Problem</b>	<b>Possible Cause</b>	<b>Remedy</b>
<b>Spindle Locks Up (Seizes and Won't Turn)</b>	Loss of lubrication in spindle	Indicated by catastrophic failure of the upper bearing. See the previous section
	Excessive bearing pre-load	Disassemble the spindle and inspect the bearings for wear. Re-assemble following the bearing pre-load specifications in the Technical Service Manual.
	Blade bar bolts too long	Installing the incorrect bolts (too long) for the blade carrier will allow the bolts to contact the lower bearing and will lock up the spindle. Install the correct bolts.
<b>Starter on Tractor Won't Crank</b>	Interference due to bent seal protector	Inspect the seal guard ring (welded to the blade carrier or bar) Replace or repair as needed.
	Wire harness incorrectly installed	Check harness attachment to the ignition switch and to the battery. Also, check for proper ground.
<b>Tractor Battery Dead or Low (Continuous Power Draining)</b>	On/Off switch malfunction	Inspect to ensure power to switch is interrupted when the switch is in the off position
	Short to ground in wire harness	Inspect for damage or heat stress to the harness. Check for shorted wires or melted insulation. Check proper connection to the ignition switch and battery.
	Battery failure	Test the battery and replace per the tractor manufacturers recommendation
	Tractor issues	Follow tractor manufacturer recommendations for troubleshooting electrical problems with the tractor.







# **MAINTENANCE SECTION**

Maintenance Section 5-1

# MAINTENANCE

MAINTENANCE

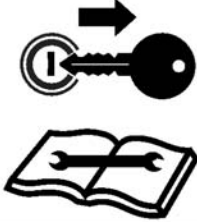
## HAZARDS WITH MAINTENANCE OF IMPLEMENT

				
Periodically inspect all moving parts, lubricate drivelines, and tighten all fasteners	Lower mower head to ground or block up before servicing	Stop engine remove key before conducting maintenance	Set mower head securely on the ground before servicing blades	Thrown Objects Hazard Ensure blades rotate clockwise viewed from above mower head

### **WARNING**

**AVOID SERIOUS INJURY OR DEATH FROM COMPONENT FAILURE BY KEEPING IMPLEMENT IN GOOD OPERATING CONDITION IN PERFORMING PROPER SERVICE, REPAIRS AND MAINTENANCE.**

#### BEFORE PERFORMING SERVICE, REPAIRS AND MAINTENANCE ON THE IMPLEMENT:

- **STOP ENGINE AND PTO**, engage parking brake, lower implement, allow all moving parts to stop and remove key before dismantling from tractor.
- **PLACE** implement on ground or securely block up raised equipment. Use large blocks on soft or wet soil.
- **PUSH and PULL** Remote Hydraulic Cylinder lever to relieve hydraulic pressure.
- **DISCONNECT** Pump solenoid valve or PTO driveline connection before servicing mower head.
- **WEAR SAFETY GLASSES, PROTECTIVE GLOVES** and follow **SAFETY PROCEDURES** when performing service, repairs and maintenance on the implement:
  - Always **WEAR** protective **GLOVES** when handling blades, knives, cutting edges or worn component with sharp edges.
  - Always **WEAR GLOVES** and **SAFETY GLASSES** when servicing hot components
  - **AVOID CONTACT** with hot hydraulic oil tanks, pumps, motors, valves and hose connection surfaces.
  - **SECURELY** support or **BLOCK UP** raised implement, framework and lifted components before working underneath equipment.
  - **FOLLOW INSTRUCTIONS** in maintenance section when replacing hydraulic cylinders to prevent component falling.
  - **STOP** any implement movements and **SHUT-OFF TRACTOR** engine before doing any work procedures.
  - **USE** ladder or raised stands to reach high equipment areas inaccessible from ground.
  - **ENSURE** good footing by standing on solid flat surfaces when getting on implement to perform work.
  - **FOLLOW** manufacturer's instructions in handling oils, solvents, cleansers, and other chemical agents.
  - **DO NOT** change any factory-set hydraulic calibrations to avoid component or equipment failures.
  - **DO NOT** modify or alter implement, functions or components.
  - **DO NOT WELD** or repair rotating mower components. These may cause vibrations and component failures being thrown from mower.

#### PERFORM SERVICE, REPAIRS, LUBRICATION AND MAINTENANCE OUTLINED IN IMPLEMENT MAINTENANCE SECTION:

- **INSPECT** for loose fasteners, worn or broken parts, leaky or loose fittings, missing or broken cotter keys and washers on pins, and all moving parts for wear.
- **REPLACE** any worn or broken parts with authorized service parts.
- Inspect mower blade spindle to ensure bearing preload. If loose repair before operating.
- **LUBRICATE** unit as specified by lubrication schedule
- **NEVER** lubricate, adjust or remove material while it is running or in motion.
- **TORQUE** all bolts and nuts as specified.

#### BLADE INSPECTION:

- Inspect blade carrier and blades daily.
- Check blade and blade carrier **BOLT TORQUE** daily. Loose bolts can cause blade or blade bolt failures.
- **REPLACE**, bent, damage, cracked and broken blades immediately with new blades.
- **AVOID** blade failures and thrown broken blades. **DO NOT** straighten, weld, or weld hard-facing blades.

#### SAFETY SHIELDS, GUARDS AND SAFETY DEVICES INSPECTION:

- **KEEP** all Deflectors, Chain Guards, Steel Guards, Gearbox Shields, and PTO integral shields, Bands, Side Skirts and Skid Shoes in place and in good condition.
- **REPLACE** any missing, broken or worn safety shields, guards and safety devices.
- Engine Exhaust, some of its constituents, and certain vehicle components contain or emit chemicals known to the state of California to cause cancer, birth defects or other reproductive harm.
- Battery posts, terminals and related accessories contain lead and lead compounds, chemicals known to the state of California to cause cancer, birth defects or other reproductive harm. **PN HMBM-01**

# MAINTENANCE

## PARTS INFORMATION

### PARTS INFORMATION

Alamo Industrial mowers use balanced and matched system components for blade carriers, blades, cuttershafts, knives, knife hangers, rollers, drivetrain components, and bearings. These parts are made and tested to Alamo Industrial specifications. Non-genuine "will fit" parts do not consistently meet these specifications. The use of "will fit" parts may reduce mower performance, void mower warranties, and present a safety hazard. Use genuine Alamo Industrial mower parts for economy and safety. (SPAM-1)

**SEE YOUR ALAMO DEALER**

## LUBRICATION INFORMATION

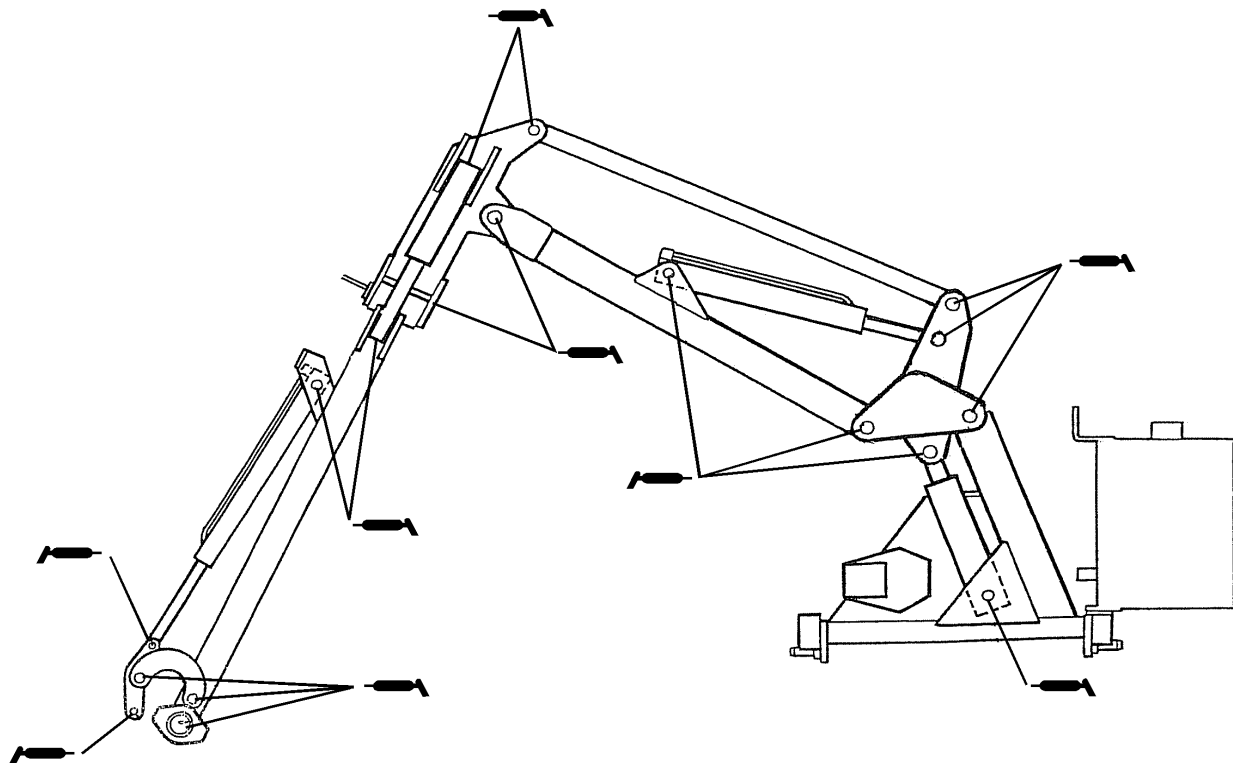

 Grease daily all points shown

Mnt-B-0081

**MAINTENANCE**

# MAINTENANCE

## PTO SHAFT LUBRICATION

Lubricate all the points indicated in the diagram below at the intervals stated using a general purpose lithium based grease.



A = 8 hours  
B = 16 hours

Mnt-B-0058

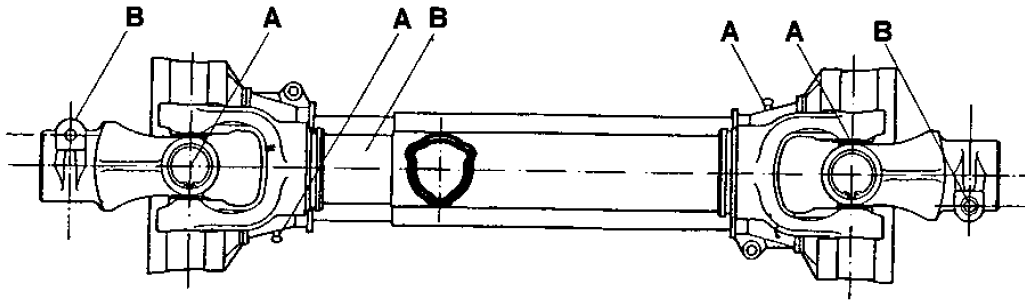

MAINTENANCE

## PTO SHAFT INSPECTION

Regularly check the PTO guards for damage and ensure the anti rotation chains are in place and that their anchor points are in good condition. Do not operate the machine with any damaged guards - replace suspect items immediately.

## PTO GEARBOX

The gearbox oil should be changed every working year or at 600 hour intervals, whichever occurs first. On lever ground gearbox should be filled until oil is visibly level with the lip of the filler plug aperture. Do not attempt to fill by removing the breather as the depth of tapped thread in the casing at the point is insufficient to allow repeated loosening and tightening of the breather plug.

The gearbox capacity is 700 mL (1-1/4 pint) use EP90 gear oil.

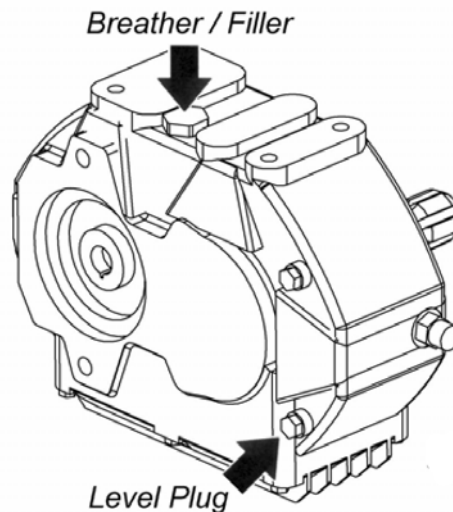

Mnt-B-0060



# MAINTENANCE

## HYDRAULIC SYSTEM

### Oil Supply

Check daily the oil level in the reservoir.

No fixed time period can be quoted for oil changes as operating conditions and maintenance standards vary so widely. Burnt and scorched oil odors and the oil darkening and thickening are all signs of oxidation and indicate the oil should be changed.

Moisture which results from condensation can become entrapped in the oil and cannot be removed by filtration so that contamination is a progressive factor.

Contamination can be reduced by:

1. Cleaning around the reservoir cap before removal, and keeping that area clean.
2. Using clean containers when replenishing the system.
3. Regular servicing of the filtration system.

### Filtration Maintenance

A 125-micron suction strainer and a low-pressure 10-micron full flow return line filter protect the machine.

#### Suction strainer

The strainer is permanently fixed within the reservoir.

Should symptoms of pump cavitation or spongy intermittent operation occur the tank must be drained and flushed out with a suitable cleaning agent e.g. clean diesel oil.

#### Return Line Filter

The elements should be changed after the first 50 hours and thereafter at 500-hour intervals. It is important to note hours worked as if the filter becomes blocked an internal by-pass within the canister will operate and no symptoms of filter malfunction will occur to jog your memory.

# MAINTENANCE

MAINTENANCE

## HYDRAULIC HOSES

The condition of all hoses should be carefully checked during routine service of the machine. Hoses that have been chafed or damaged on their outer casing should be securely wrapped with waterproof adhesive tape to stop the metal braid from rusting. Hoses that have been suffered damage to the metal braid should be changed at the earliest opportunity.

### Hose Replacement

1. Replace one hose at a time to avoid the risk of wrong connections.
2. When the hose is screwed to an additional fitting or union, use a second spanner on the union to avoid breaking both seals.
3. Do not use jointing compound on the threads.
4. Avoid twisting the hose. Adjust the hose line to ensure freedom from rubbing or trapping before tightening hose end connections.

Before changing hoses, study the installation. These are carefully calculated to prevent hose damage during operation. Always replace hoses in exactly the same manner. This is especially important for the flail hoses where they must be crossed, upper to lower, at the dipper and head pivots.

### Hose Warranty

Warranty is limited to replacement of hoses which have failed due to faulty materials of manufacture. Warranty will not be considered on hoses that have suffered damage by abrasion, cuts or being pinched or trapped while in work. Neither will a claim be considered where a hose end has been damaged by a blow or where the threads or unions have been damaged by overtightening.

RECOMMENDED HOSE END TORQUE VALUES FOR 37 DEGREE ANGLE STEEL HOSE END FITTINGS			
DASH SIZE	NOMINAL SIZE (IN.)	TORQUE (IN.LBS.)	VALUE* (FT.LBS.)
-4	1/4	140	12
-6	3/8	230	19
-8	1/2	450	38
-10	5/8	650	54
-12	3/4	900	75
-16	1	1200	100
-20	1-1/4	1600	133
-24	1-1/2	2000	167
-32	2	2800	233

\* Straight threads do not always seal better when higher torques are used.  
Too much torque causes distortion and may lead to leakage.

Mnt-B-0004

Soft Seal hose connections are capable of holding pressure when the nut is only 'finger tight'. It is therefore recommended that when dismantling, the hose be manually flexed to relieve any residual pressure with the retaining nut slackened prior to complete disassembly.

# MAINTENANCE

## CABLES

The cables operate on a push/pull system with the spool centering springs always returning the spool to the neutral position when the handle is released.

Care should be taken during installation and operation to ensure that the cables are not trapped or kinked. Any abrasion or damage to the outer casing should be sealed with plastic insulation tape to avoid moisture penetrating.

No routine adjustment of the cables are necessary as they do not stretch. The threaded collar is correctly adjusted when the lever is in a vertical position in its housing allowing an equal amount of travel in either direction.



On no account should any attempt be made to lubricate the cables which are assembled with a special lubricant during manufacture.

**NOTE:** Be careful in determining the correct cable connections on both the control unit and the valve in the event of cable replacement.

## CYLINDER ROD MAINTENANCE

It is important to visually inspect the hydraulic cylinder rods daily before use. It is highly recommended that while the machine is stored or getting very little use that a protectant is applied to the hydraulic cylinder rods to prevent degradation. If the machine receives more frequent use, be sure to fully cycle each cylinder function so that the cylinder rod is coated by the systems hydraulic fluid. Depending on your operating environment it may be necessary, under normal operating conditions, to apply a protective lubricant to the cylinder rods for protection against rust and pitting. Hydraulic fluid may provide a suitable amount of protection, but remember any protectant can attract dust and debris so attention must be given to the cylinder rods daily. Also remember that any other protectant must be compatible with hydraulic fluid. Alamo Industrial is not responsible for rust or pitting of the cylinder rod due to weather exposure or impacts from normal operation or mounting. If hydraulic cylinders and or the cylinder rods are damaged as a result of the rods rusting or pitting, the hydraulic cylinders and rods will not be covered under warranty by Alamo Industrial.

# MAINTENANCE

## MAINTENANCE

### Boom Cylinder Removal and Replacement Instructions

1. Clear the area of all personnel before lowering the boom mower head.
2. From the tractor seat with your seat belt fastened around you, Lower the boom mower head to the ground. Extend the boom to the furthest reach and lower the mower head flat on the ground. DO NOT attempt to replace the cylinders with the boom in the raised or transport position.
3. Shut off the tractor, engage the parking brake, place the tractor transmission in the park position, and remove the key before dismounting.
4. Allow the system to cool to room temperature before removing any hydraulic components.
5. Wear Safety glasses and impenetrable gloves when working with hydraulic hoses and fittings.
6. Release all oil pressure from the hydraulic circuit by manually stroking each valve section with the tractor engine off. Utilize the Manual Override function if the unit is equipped with an electric over hydraulic valve.
7. Utilize blocks, jack stands or a suitable over head hoist to support the weight of the boom section and remove pressure from the cylinder mounting pins.
8. Check to see that the cylinder to be replaced is not under pressure by moving the cylinder pins by hand. The pins should be loose and should slide from the pin bore easily. If the pins are tight and cannot be moved, the cylinder may be under pressure. Make sure the boom components are properly supported and that the pressure is relieved from the circuit.
9. Cylinder assemblies are heavy and can fall when the pins are removed. Support the hydraulic cylinder with a suitable hoist or jack.
10. Slowly loosen the hydraulic connections to the cylinder. Carefully unscrew hose fitting and allow any remaining pressure to bleed off. Use Extreme Care. Oil must be cool, and the technician should stand to the side to prevent exposure to any hydraulic oil. Always consult the Material Safety Data Sheet and wear any required Personal Protective Equipment. A catch pan may be required to retain any spilled oil.
11. Cap both ends of the fitting with suitably sized metal caps.
12. Remove the cylinder pins starting with the ROD end cylinder pin. Make sure the cylinder is properly supported, and remove the base end cylinder pin. The cylinder may be heavy, use proper lifting techniques to lift and handle the cylinder. If needed, get assistance from another person to safely lift the cylinder from the machine.
13. Measure the distance between the cylinder pin holes and extend the new cylinder the correct length prior to attempting an installation.
14. Install the new cylinder in place and install both cylinder pins and retaining hardware.
15. Remove the metal caps, and re-install the hydraulic hoses.
16. Check the hydraulic reservoir of the boom mower to ensure there is sufficient oil. Follow the manufactures recommendations for proper oil type and filtering techniques and requirements to add oil to the system.
17. Clear the area of all persons prior to starting the tractor.
18. Consult the Operator's Manual for instruction in regard to the proper operating procedure.
19. From the tractor seat, with the seat belt fastened, operate the boom to ensure proper operation of the boom function.
20. From the tractor seat, with the seat belt fastened, operate the boom controls to fully extend and retract the new cylinder several times to purge any trapped air from the system.
21. From the tractor seat, with the seat belt fastened, look for signs of and oil leak. If an oil leak is observed, shut the tractor down and follow the steps to remove pressure from the hydraulic circuit. Identify the source of the leak, and resolve the issue.
22. Upon completion of the required repairs, return to Step # 16 to recheck the cylinder for proper operation.

# MAINTENANCE

**MAINTENANCE**

## Hydraulic Component Maintenance Schedule

Component	Hours of Operation											
	Installation	200	400	600	800	1000	1200	1400	1600	1800	2000	2200
Pump Drive Shaft Check and Lubricate	x	x	x	x	x	x	x	x	x	x	x	x
Pump Mounting Bolt torque check (Inspect Daily)	x	x	x	x	x	x	x	x	x	x	x	x
Charge Pump Filter	Installation	x			x				x			
Pressure Filter to the Control Valve	Installation	x			x				x			
Return Canister Filter Element	Installation	x			x				x			
Hydraulic Oil Change	Installation	x							x			
Hydraulic Oil Particle Count Testing	x	x			x				x			
Hydraulic Tank Breather Filter	Installation	Inspect							Replace			
Hydraulic Tank Suction Screen	Installation	Inspect							Inspect			
Hydraulic Hose Inspection/Replacement	Installation	Inspect	Inspect	Inspect	Inspect	Inspect	Inspect	Inspect	Inspect	Inspect	Inspect	Inspect
Cooling Fan Clean and Inspect	Daily	Daily	Daily	Daily	Daily	Daily	Daily	Daily	Daily	Daily	Daily	Daily
Check Hydraulic Fluid Level (Inspect Daily)	Daily	Daily	Daily	Daily	Daily	Daily	Daily	Daily	Daily	Daily	Daily	Daily
Mower Blades Replace (INSPECT DAILY)		x	x	x	x	x	x	x	x	x	x	x
Blade Bolts Replace (INSPECT DAILY)		x	x	x	x	x	x	x	x	x	x	x
Blade Bar Assembly Replace	Installation					x					x	
Spindle Lube Replacement (INSPECT DAILY)	x					x					x	
Spindle Bearing Pre-load Inspection	x	x	x	x	x	x	x	x	x	x	x	x
Mower Debris Guard Inspect/Replace	x	x	x	x	x	x	x	x	x	x	x	x
Pivot Point Lubrication	Daily	Daily	Daily	Daily	Daily	Daily	Daily	Daily	Daily	Daily	Daily	Daily
King Pin Bearing Replacement	Installation								x			
Pivot Pin Bearing replacement (Steel)	Installation								x			
Pivot Pin Bearing Replacement (Fiber)	Installation					x					x	
Inspect Operation And Safety Decals Replace when faded, torn or missing.	x	x	x	x	x	x	x	x	x	x	x	x

**Repeat the Maintenance Schedule based on the hours indicated for the life of the machine**

## PROPER TORQUE FOR FASTENERS

The chart lists the correct tightening torque for fasteners. When bolts are to be tightened or replaced, refer to this chart to determine the grade of bolts and the proper torque except when specific torque values are assigned in manual text.

RECOMMENDED TORQUE IN FOOT POUNDS UNLESS OTHERWISE STATED IN THE MANUAL \*

**NOTE:** These values apply to fasteners as received from supplier, dry or when lubricated with normal engine oil. They do not apply if special graphitic or molydisulphide greases or other extreme pressure lubricants are used. This applies to both UNF fine and UNC coarse threads.

# MAINTENANCE

## TORQUE SPECIFICATIONS

Proper torque for American fasteners.  
Recommended Torque in Foot Pounds (Newton Meters).\*

### AMERICAN Bolt Head Markings

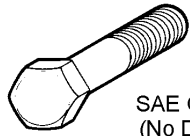

SAE Grade 2  
(No Dashes)

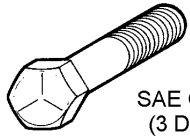

SAE Grade 5  
(3 Dashes)

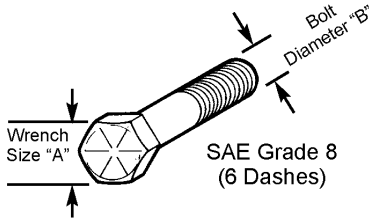

SAE Grade 8  
(6 Dashes)

WRENCH SIZE (IN.) "A"	BOLT DIAMETER (IN.) "B" AND THREAD SIZE	SAE GRADE 2	SAE GRADE 5	SAE GRADE 8
7/16	1/4 - 20 UNC	6 (7)	8 (11)	12 (16)
7/16	1/4 - 28 UNF	6 (8)	10 (13)	14 (18)
1/2	5/16 - 18 UNC	11 (15)	17 (23)	25 (33)
1/2	5/16 - 24 UNF	13 (17)	19 (26)	27 (37)
9/16	3/8 - 16 UNC	20 (27)	31 (42)	44 (60)
9/16	3/8 - 24 UNF	23 (31)	35 (47)	49 (66)
5/8	7/16 - 14 UNC	32 (43)	49 (66)	70 (95)
5/8	7/16 - 20 UNF	36 (49)	55 (75)	78 (106)
3/4	1/2 - 13 UNC	49 (66)	76 (103)	106 (144)
3/4	1/2 - 20 UNF	55 (75)	85 (115)	120 (163)
7/8	9/16 - 12 UNC	70 (95)	109 (148)	153 (207)
7/8	9/16 - 18 UNF	79 (107)	122 (165)	172 (233)
15/16	5/8 - 11 UNC	97 (131)	150 (203)	212 (287)
15/16	5/8 - 18 UNF	110 (149)	170 (230)	240 (325)
1-1/8	3/4 - 10 UNC	144 (195)	266 (360)	376 (509)
1-1/8	3/4 - 16 UNF	192 (260)	297 (402)	420 (569)
1-5/16	7/8 - 9 UNC	166 (225)	430 (583)	606 (821)
1-5/16	7/8 - 14 UNF	184 (249)	474 (642)	668 (905)
1-1/2	1 - 8 UNC	250 (339)	644 (873)	909 (1232)
1-1/2	1 - 12 UNF	274 (371)	705 (955)	995 (1348)
1-1/2	1 - 14 UNF	280 (379)	721 (977)	1019 (1381)
1-11/16	1-1/8 - 7 UNC	354 (480)	795 (1077)	1288 (1745)
1-11/16	1-1/8 - 12 UNF	397 (538)	890 (1206)	1444 (1957)
1-7/8	1-1/4 - 7 UNC	500 (678)	1120 (1518)	1817 (2462)
1-7/8	1-1/4 - 12 UNF	553 (749)	1241 (1682)	2013 (2728)
2-1/16	1-3/8 - 6 UNC	655 (887)	1470 (1992)	2382 (3228)
2-1/16	1-3/8 - 12 UNF	746 (1011)	1672 (2266)	2712 (3675)
2-1/4	1-1/2 - 6 UNC	870 (1179)	1950 (2642)	3161 (4283)
2-1/4	1-1/2 - 12 UNF	979 (1327)	2194 (2973)	3557 (4820)

### METRIC

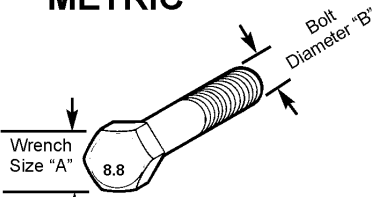

Numbers appearing on bolt heads indicate ASTM class.

Proper torque for Metric fasteners.  
Recommended torque in Foot Pounds (Newton Meters).\*

WRENCH SIZE (mm) "A"	BOLT DIA. (mm) "B"	ASTM 4.6	ASTM 8.8	ASTM 9.8	ASTM 10.9
8	5	1.8 (2.4)		5.1 (6.9)	6.5 (8.8)
10	6	3 (4)		8.7 (12)	11.1 (15)
13	8	7.3 (10)		21.1 (29)	27 (37)
16	10	14.5 (20)		42 (57)	53 (72)
18	12	25 (34)	74 (100)	73 (99)	93 (126)
21	14	40 (54)	118 (160)	116 (157)	148 (201)
24	16	62 (84)	167 (226)	181 (245)	230 (312)
30	20	122 (165)	325 (440)		449 (608)
33	22		443 (600)		611 (828)
36	24	211 (286)	563 (763)		778 (1054)
41	27		821 (1112)		1138 (1542)
46	30	418 (566)	1119 (1516)		1547 (2096)

\*Use 75% of the specified torque value for plated fasteners. Use 85% of the specified torque values for lubricated fasteners.

Mnt-B-0005

# MAINTENANCE

## FLAILHEAD

1. Frequently inspect the rotor assembly for damaged or missing flails. Bolts and nuts securing the flails to the rotor should be regularly checked and kept tight. The correct torque setting for these locknuts is 135 Nm (100 lbs/ft.). Use only the correct flail bolt and locking nut. Check the flail pivot bushes for possible damage or wear. They do not require oil.
2. Do not attempt to run the rotor with flails missing. Imbalance will cause severe vibration and can rapidly damage the rotor shaft bearings. As an emergency measure, if a flail is broken off or lost, remove another on the opposite site of the rotor to retain balance. Always replace flails in opposite pairs and never match up a new flail with a resharpened one which will of course be lighter.
3. Blunt flails absorb a lot of power and leave an untidy finish to work. They should be sharpened on a grindstone or with a portable grinder periodically. Blades **MUST BE** sharpened in pairs.
4. Wear protective gear when sharpening flails.
5. Ensure that the bearing housings and hydraulic mounting nuts and bolts are kept tight. They should be checked during servicing.

MAINTENANCE

# MAINTENANCE

## Flail Blades Inspection



Inspect the Blades daily for abnormal wear. REPLACE ALL BLADES on the carrier IMMEDIATELY if any blades have:

- Become bent or deformed from its original shape, or
- Wear inside the blade bolt hole, or
- Any cracks are visible, or
- Deep gouges in the blade's surface are present, or
- Gouges or chipped areas in the cutting edge are larger than 1/4"(8mm), or
- The material on the leading edge has been worn away by more than 1/4"(8mm)

**DO NOT** straighten, sharpen, weld or hard-face blades

Failure to replace worn or damaged blades may lead to catastrophic failure of the blades and ejection of the broken part with tremendous force which may cause serious bodily injury or death.

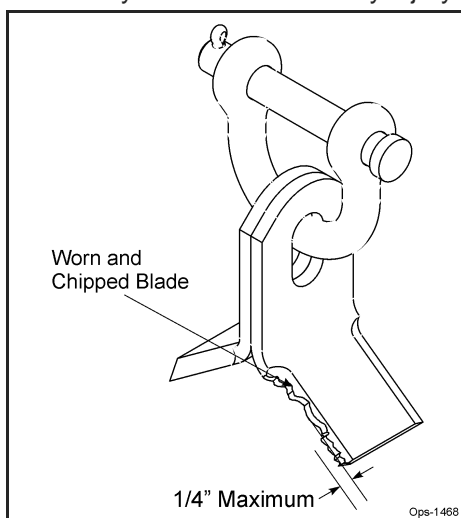

Always replace blades in sets

- Blades that are damaged may indicate severe service or abuse. If one blade is worn or damaged other blades on the same shaft will have been subjected to the same severe service or abuse.
- The Flail rotor turns at speeds exceeding 2000 RPM and is dynamically balanced at the factory. Differences in blade weight between used blades with loss of material from gouges or wear as compared to new blades can cause severe vibration and damage to the Flail rotor. Always replace blades as complete sets.

### Important

Use only genuine Bush Hog replacement blades and fasteners. Other blades and fasteners may not meet the Bush Hog requirements and could fail during operation resulting in part being thrown out from under the mower.



Never attempt to sharpen blades. OPS-U-0046



# MAINTENANCE

## Blade Pins and D-Ring Inspection

Blade Pins and D-Rings daily for wear or damage as follows:



Inspect the Blade pins and D-Rings daily for abnormal wear. Make sure the cotter pins are in place and properly spread. REPLACE BLADE Pins and D-Rings IMMEDIATELY if they have:

- Visible cracks or
- If a Pin or D-Ring has visible worn areas, or
- If a Pin or D-Ring has gouges or chipped areas

Failure to replace abnormally worn pins or D-Rings may lead to catastrophic failure and ejection of the broken part which may cause serious bodily injury or death.

Always replace the pins and D-Rings whenever excessive wear is noticed.

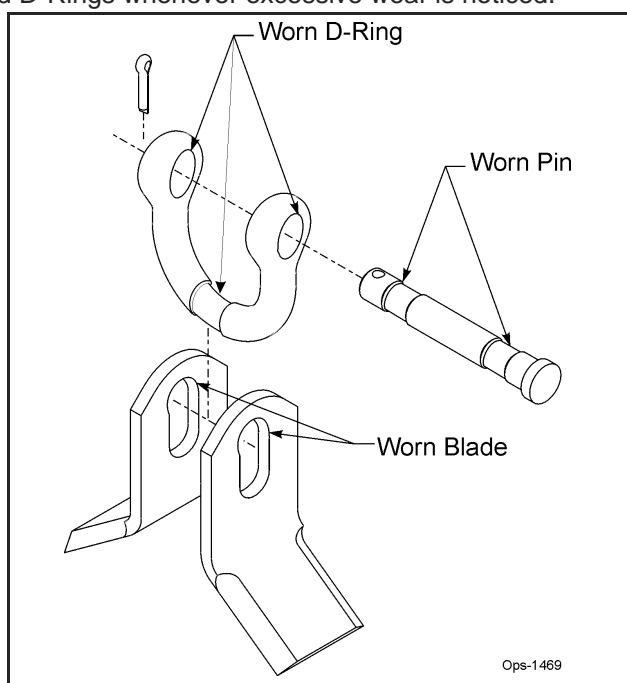

### Important

If the cotter pins are broken by contact with other flail blades, remove the pin and reverse the direction the pin is inserted through the D-Ring so that the cotter pin is on the opposite side of the D-Ring. This will prevent the next set of blades from swinging back and hitting the cotter pin. OPS-U-0045

# MAINTENANCE

## General Information on Flail Mower Vibration

FLAIL MOWERS - INFORMATION BULLETIN NO. 5

Excessive Vibration

Vibration is a **MONSTER** and if allowed to continue unchecked, can cause the complete break-up of a machine in a very short time.

A properly operated Flail Mower will produce very little vibration. If vibration does occur, the mower should be stopped and the trouble corrected, **as warranty does not cover failures resulting from continued operation after something happens to cause the mower to vibrate excessively.**

Vibration is caused by a rotating part which is out of balance. This could be the cutter shaft or, on those models having a universal slip joint assembly drive shaft, from the drive shaft.

If the two extreme ends of the drive shaft, (the splined yokes which fit on the tractor power take off shaft and on the mower gear box driven shaft), are not parallel, vibration will be evident. This is because of the mechanics of a universal drive wherein the rotational speed through a universal joint is not uniform. If the ends of a universal drive shaft are parallel, the uneven rotation effect is cancelled out and the machine being driven will be driven at a uniform rate of speed. However, if the ends are not parallel, the uneven rotation effect may be multiplied, resulting in a speeding up and slowing down of the entire mower system (gear box, extension shaft, pulleys, belt, and cutter shaft) each revolution. This effect can be readily noticed if the mower, while running, is raised to an extreme height on the tractor lift.

For smoothest operation, the tilt of the mower should be adjusted (on a 3-point hitch, by adjusting the length of the top link between the tractor and the mower) so that the ends of the drive shaft are parallel when the mower is down in operating position. Raising the mower while running, to extreme heights on the lift should be avoided.

To check where the vibration is originating, first be sure the ends of the universal drive shaft are parallel. Then, if vibration is still present, remove the drive belt and run the mower. If vibration is still present, it most likely is coming from and caused by a bent drive shaft. If so, the shaft should be replaced or straightened. If the vibration is gone - the drive portion of the mower is running smoothly - then the vibration is probably coming from the cutter shaft (it could be a pulley out of balance or a faulty belt with a varying cross section, but this is not likely).

**The cutter shaft will run out of balance if:**

1. **Wire, rope, string, rags, etc., around the cutter shaft** are holding the knives in a folded back position. Remove such foreign objects and be sure all knives are free to swing to the extended position.
2. **Knives are missing or broken.** Replace missing or broken knives.
3. **Knife hanger lugs are broken off shaft.** This condition usually results from continued operation in contact with large hard objects where the knife hanger lugs themselves are hitting the hard objects. Lugs should be replaced using arc welding equipment so as not to direct too much heat in one area of the shaft.
4. **Cutter shaft ball bearings are worn** enough to have radial "play" in them. Replace ball bearing and other worn parts to eliminate "play".
5. **Shaft is bent.** The shafts are straight within a couple of thousandths of an inch when they are made. It is possible that they will become bent in use, such as if the shaft is hooked on a stump while the tractor is moving forward at good speed.
6. **Shafts are operated at improper speed.** Rotating shafts have what is known as a natural period of vibration. The same is true of the cutter shafts on the Flail Mowers.

The actual speed at which the harmonic will occur will vary with each mower and each installation. To avoid this harmonic vibration when operating the mower, it may be necessary to adjust the engine speed of the tractor up or down.

Some units have a harmonic which occurs below the nominal operating speed. On these units, it will be noticed that there is always a little vibration at a particular RPM as the mower is being sped up to operating speed. This occurs as the shaft passes through its normal harmonic vibration point. As long as the mower is opened at the proper speed, then harmonic vibration will not be an issue.



# SEGURIDAD

## INFORMACIÓN DE PARTES

### INFORMACIÓN DE PARTES

Cortacéspedes de ALAMO INDUSTRIAL usan balanceado y componentes del sistema de igualdad para los portadores de la lámina, las láminas, los cortador-ejes, los cuchillos, las suspensiones del cuchillo, los rodillos, los componentes del engranajes de conducción y los cojinetes. Estas piezas se hacen y se prueban a las especificaciones de ALAMO INDUSTRIAL. Partes de No-genuino "cabrer" piezas no resuelven constantemente estas especificaciones. El uso de "cabrer" piezas puede reducir el funcionamiento del cortacéspedes, garantias vacías del cortacéspedes y presentar un peligro de seguridad. ! Utilice las piezas genuinas de cortacéspedes del ALAMO INDUSTRIAL para la economía y la seguridad! (SPAM-1 SP)

### VEA A SU VENDEDOR ALAMO INDUSTRIAL





**NOTA:** Para ver las calcomanías en español por favor de referirse a la pagina 1-25 en la seccion de seguridad en ingles.

**NOTA:** Si necesita un manual completamente en español por favor de ponerse en contacto a; *Translations, dirección 1502 E. Walnut Street Seguin, TX 78155; Fax: (830) 372-9529*

SEGURIDAD

# SEGURIDAD

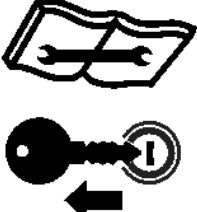
## RIESGOS CON EL MANTENIMIENTO DEL IMPLEMENTO

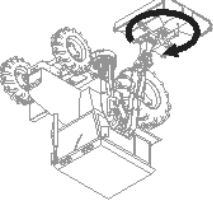
	Inspeccione periódicamente todas las partes móviles, lubrique las líneas de conducción y ajuste todas las sujeciones.
	Baje el cabezal de la cortadora hasta el suelo o bloquéelo antes de repararlo.
	Apague el motor. Quite la llave antes de realizar tareas de mantenimiento.
	Baje el cabezal a una posición segura sobre el suelo antes de reparar las cuchillas.
	Riesgo de objetos arrojados por la cortadora. Asegúrese de que las cuchillas giren en sentido horario desde arriba del cabezal de la cortadora.

### ⚠️ ADVERTENCIA

MANTENGA LOS IMPLEMENTOS EN BUENAS CONDICIONES DE FUNCIONAMIENTO, A TRAVÉS DE UN SERVICIO, REPARACIÓN O MANTENIMIENTO APROPIADO.

### ANTES DE REALIZAR TAREAS DE SERVICIO, REPARACIÓN Y MANTENIMIENTO DEL IMPLEMENTO:

- **APAGUE EL MOTOR Y EL PTO, COLOQUE EL FRENO DE MANO, DESCENDA EL IMPLEMENTO, ESPERE A QUE SE DETENGAN TODAS LAS PARTES MÓVILES Y quite la llave antes de bajarse del tractor.**
- **COLOQUE** el implemento sobre el suelo o trabe de manera segura los equipos elevados. Utilice bloques grandes sobre suelo blando o húmedo.
- **EMPÚJE Y JALE** la palanca del Cilindro Hidráulico Remoto para liberar la presión hidráulica.
- **DESCONECTE** la válvula de solenoide de la bomba o la conexión de la línea de conducción de la TDF de antes de reparar el cabezal de la cortadora.
- **USE GAFAS DE SEGURIDAD Y GUANTES PROTECTORES** y siga todos los procedimientos de seguridad al realizar tareas de servicio, reparación y mantenimiento sobre el implemento:
- **Siempre USE GUANTES** protectores al manipular las hojas, cuchillas, bordes filosos o un componente desgastado con bordes filosos.
- **Siempre USE GUANTES Y GAFAS DE SEGURIDAD** al reparar componentes en caliente
- **EVITE EL CONTACTO** con tanques de aceite hidráulico, bombas, motores, válvulas y superficies de conexión de mangueras calientes.
- **SUJETE FIRMEMENTE** o **TRABE EN POSICIÓN ELEVADA** todos los implementos, bastidores y componentes elevados antes de trabajar sobre los equipos que se encuentran debajo.
- **SIGA LAS INSTRUCCIONES** de la sección de mantenimiento al reemplazar los cilindros hidráulicos para evitar la caída de componentes.
- **DETENGA** el movimiento de todos los implementos y **APAGUE EL MOTOR DEL TRACTOR** antes de realizar ninguna tarea.
- **USE** una escalera o gradas elevadas para alcanzar áreas altas del equipo a las que no se pueda acceder desde la tierra.
- **ASEGURESE** de estar bien apoyado sobre superficies sólidas planas al subir al implemento para realizar tareas.
- **SIGA** las instrucciones del fabricante sobre cómo manipular los lubricantes, solventes, implantes, y otros agentes químicos.
- **NO** cambie ninguna calibración hidráulica de fábrica para evitar fallas de los componentes o equipos.
- **NO** modifique o altere el implemento, las funciones o componentes.
- **NO** SUELDE o repare los componentes de la cortadora. Esto puede causar vibraciones y fallas de los componentes que se desprendan de la cortadora.

### SECCIÓN DE MANTENIMIENTO DEL IMPLEMENTO:

- **INSPECCION** el implemento para detectar sujeciones sueltas, partes gastadas o rotas, ajustes sueltos o con filtraciones, que los pasadores tengan chavetas y arandelas, y las partes móviles para detectar el desgaste.
- **REEMPLACE** todas las partes gastadas o rotas con repuestos autorizados.
- **INSPECCION** el uso de la cuchilla de la cortadora para asegurar la carga previa de los rodamientos. Si está suelto, repárelo antes de operar.
- **LUBRIQUE** la unidad tal como se especifica en el cronograma de lubricación.
- **NUNCA** lubrique, ajuste o quite material mientras el equipo está en funcionamiento o movimiento.
- **AJUSTE** todas las tuercas y pernos tal como se especifica.



### INSPECCION DE CUCHILLAS:

- **INSPECCION** el soporte de la cuchilla y las cuchillas a diario.
- **INSPECCION** el **AJUSTE DE LOS PERNOS** del soporte de la cuchilla y las cuchillas a diario.
- **REEMPLACE** las cuchillas dobladas, dañadas, agrietadas o rotas inmediatamente por cuchillas nuevas.
- **EVITE** fallas de las cuchillas y que vuelen trozos de cuchillas. **NO** enderece, suelde o suelde con superficies rígidas.
- **INSPECCION DE PROTECTORES DE SEGURIDAD, GUARDAS Y DISPOSITIVOS DE SEGURIDAD:**
- **MANTENGA** en su lugar y en buen estado todos los deflectores, protectores de cadena, protectores de acero, cubiertas de caja de engranajes, cubiertas integrales de PTO, bandas, faldores laterales y zapatas antideslizantes.
- **REEMPLACE** cualquier protector, cubierta o dispositivo de seguridad falto, roto o gastado.
- El escape del motor, al igual que algunos de sus componentes, y determinados elementos del vehículo contienen o emiten agentes químicos que el estado de California ha determinado que causan cáncer, defectos de nacimiento y otros daños reproductivos.
- Las terminales de baterías y los accesorios relacionados contienen plomo y componentes de plomo, que el estado de California ha determinado son químicos que causan cáncer, defectos de nacimiento y otros daños reproductivos.

# SEGURIDAD

# SEGURIDAD

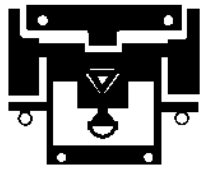
## RIESGOS EN TRANSPORTE

		
Use señales de SMV (vehículo de movimiento lento) y balizas	Riesgo de pérdida de control al detenerse	Riesgo de pérdida de control al acelerar



PARA EVITAR LESIONES GRAVES O LA MUERTE AL REMOLCAR O TRANSPORTAR EQUIPOS:

- **MANTENGA** la velocidad de transporte **POR DEBAJO DE 20 millas por hora** para mantener el control del equipo.
- **REDUZCA LA VELOCIDAD** en terreno inclinado, en las curvas y en condiciones de remolque desfavorables.
- **NO REMOLQUE** camiones u otros vehículos
- **USE** un tractor de tamaño adecuado y equipado en función del equipo de remolque.
- **SIGA** todas las reglamentaciones de tránsito locales.
- **REQUISITOS DEL TRACTOR PARA REMOLCAR O TRANSPORTAR IMPLEMENTOS:**
  - **SÓLO TRANSPORTE** en el tractor con el mecanismo **ROPS** (antivuelco) en posición elevada.
  - **USE** un tractor de tamaño adecuado y equipado, que supere el peso del implemento en al menos un 20%
  - **MANTENGA EL 20% del peso del tractor** en las ruedas frontales para mantener la dirección en forma segura.

### INSPECCIÓN DEL TRACTOR:

- **VERIFIQUE** la dirección y los frenos para asegurarse el correcto funcionamiento y las condiciones adecuadas.
- **VERIFIQUE LLEVAR EL AVISO DE SMV**, los reflectores y las luces de advertencia para la adecuada operación y visibilidad detrás de la unidad.
- **VERIFIQUE** que no haya impedimentos a la visión mientras conduce, en el tractor, la cabina o el implemento, sentado en el asiento del tractor.
- **AJUSTE** su posición de conducción, los espejos y el transporte del implemento para tener una visión clara para condiciones de conducción y tránsito.

### PREPARE EL IMPLEMENTO PARA EL TRANSPORTE O EL REMOLQUE:

- Guarde el brazo y la cortadora en posición de transporte y conecte las trabas de transporte si existen.
- **DETERMINAR LAS CARACTERÍSTICAS DE DETENCIÓN DEL TRACTOR Y EL IMPLEMENTO PARA EL TRANSPORTE O REMOLQUE:**

### PRUEBAS DE FRENADO:

- La distancia de frenado puede aumentar con el implemento conectado.
- Observe las distancias de **DETECCIÓN** con el aumento de velocidad.
- **DETERMINE** la velocidad de transporte máxima segura que no supere las 20 millas por hora.
- Reduzca la velocidad en caminos mojados o cubiertos de hielo; las distancias de frenado aumentan.
- **DETERMINE LA VELOCIDAD DE GIRO MÁXIMA ANTES DE OPERAR EN CARRETERAS O TERRENO IRREGULAR:**

- **PONGA A PRUEBA** el equipo aumentando lentamente la velocidad en las curvas para determinar si se puede operar a mayor velocidad.
- **USE MENORES** velocidades de giro en las curvas pronunciadas para evitar el vuelco.



### AL REMOLCAR O TRANSPORTAR EL EQUIPO:

- Siempre **USE EL CINTURÓN DE SEGURIDAD** al operar o transportar la cortadora.
- **USE** bajas velocidades para evitar el vuelco con el implemento elevado.
- **USE** bajas velocidades y dirección gradual en las curvas, colinas, o en superficies irregulares o poco uniformes, y en carreteras mojadas.
- **ENCIENDA LAS BALIZAS DE ADVERTENCIA** del tractor.
- **TENGA EN CUENTA** el espacio necesario para el vaivén del implemento en las curvas.
- **MANTENGA** el brazo y cortadora elevadas a 3 metros (10 pies) o una mayor distancia de todos los cables de alimentación y obstrucciones elevadas.

PN THBM-01 SP

# SEGURIDAD

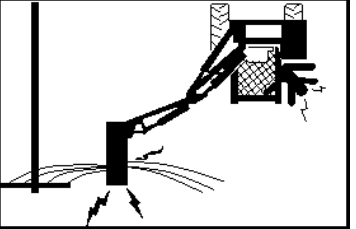
## RIESGOS ELÉCTRICOS Y DE FUEGO

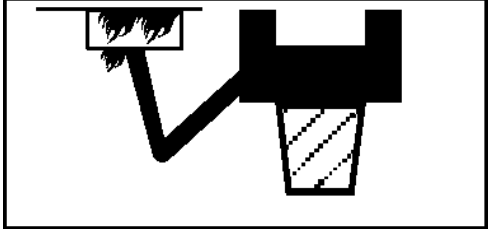
		
<p>Cabezal o brazo en contacto con cables eléctricos elevados</p>	<p>Riesgo de choque y explosión Contacto de paletas con líneas de servicios o gas</p>	<p>Riesgo de incendio. No opere cerca de fuego. Mantenga los residuos legos de las válvulas y las bombas hidráulicas.</p>

### ⚠ PELIGRO

PARA EVITAR LESIONES GRAVES O LA MUERTE POR CONTACTO ELÉCTRICO AL TRABAJAR CERCA DE CABLES ELÉCTRICOS, LÍNEAS DE GAS Y DE SERVICIOS:

- **INSPECCIONE** el área de corte para que no interfiera con cables de alimentación eléctricos subterráneos, obstrucciones, líneas de gas, cables y servicios, estructuras municipales o de otro tipo.
- **MANTENGA** todas las alas elevadas a 3 metros (10 pies) o una mayor distancia de todos los cables de alimentación y obstrucciones elevadas.
- **NO ponga en contacto la cortadora con ninguna estructura u obstrucción de servicios o municipales.**
- **LLAME AL 811 y al 1-800-258-0808 para identificar cables de servicios subterráneos.**
- **PAUTAS DE PREVENCIÓN DE INCENDIOS** durante la operación, reparación y servicio de la cortadora y el tractor, a fin de reducir el riesgo de incendio del equipo y de la vegetación:
- **El tractor debe estar EQUIPADO CON MATAFUEGOS**
- **NO OPERE** la cortadora sobre un tractor equipado con escape debajo del bastidor
- **NO FUME** ni acerque fuego directo a la cortadora o el tractor
- **NO CONDUZCA** sobre residuos encendidos o en áreas recientemente quemadas
- **EVITE LA FORMACIÓN DE CHIPAS** al no permitir que la hoja de la cortadora entre en contacto con objetos sólidos como metal o roca.
- **NO OPERE** el equipo con filtraciones de aceite o combustible. Repare cualquier filtración de aceite y retire el aceite acumulado antes de operar.
- **LIMPIE** todo resto de hierba o residuo acumulado alrededor de las líneas de conducción de la cortadora, los embragues deslizantes y cajas de cambios.
- **APAGUE EL MOTOR** al cargar combustible *PN EFBM-01 SP*

# SEGURIDAD

## RIESGO DE FILTRACION DE ACEITE HIDRÁULICO DE ALTA PRESIÓN

 <p>Penetración de aceite de alta presión en la piel</p>	 <p>Erosión de la piel por el aceite de alta presión</p>	 <p>Usar cartón para detectar filtraciones de aceite</p>	 <p>Los contenidos del tanque están bajo presión Permita que el aceite se enfríe antes de quitar la tapa.</p>
---	--	---	--

**▲ PELIGRO** PARA EVITAR LESIONES GRAVES O LA MUERTE POR PENETRACIÓN DE FILTRACIONES DE ACEITE HIDRÁULICO DE ALTA PRESIÓN:

- **NO OPERE** el equipo con filtraciones de aceite o combustible.
- **MANTENGA** todas las mangueras hidráulicas, líneas y conexiones en **BUEN ESTADO** y **AJUSTADAS** antes de aplicar presión al sistema.
- **LIBERE LA PRESIÓN HIDRÁULICA** antes de desconectar las líneas o trabajar en el sistema.
- **QUITTE** y **reemplace** la manguera si sospecha que tiene filtraciones. Solicite al distribuidor que verifique si hay filtraciones.

### LAS FILTRACIONES DE LÍQUIDO DE ALTA PRESIÓN PUEDEN NO SER VISIBLES. AL VERIFICAR FILTRACIONES HIDRÁULICAS Y TRABAJAR CERCA DE LOS SISTEMAS HIDRÁULICOS:

- **SIEMPRE USE** gafas de seguridad y guantes impenetrables.
- **USE** papel o cartón para verificar si hay filtraciones.
- **NO USE** las manos o partes del cuerpo para detectar filtraciones.
- **MANTENGA** las manos y el cuerpo **LEJOS** de los orificios de clavijas y boquillas de eyección de fluido hidráulico. El fluido hidráulico puede causar gangrena si no es extraído quirúrgicamente de inmediato por un médico especializado en este tipo de lesiones.

### Tenga cuidado cuando retire la tapa del tanque hidráulico.





- Los contenidos del tanque pueden estar bajo presión.
- Siempre permita que el aceite se enfríe antes de quitar la tapa.
- Libere la presión de aceite antes de retirar la tapa lentamente.
- Alejese del aceite caliente que pueda rociarse desde el tanque. *PN HFBM-01 SP*



# SEGURIDAD

# SEGURIDAD

## RIESGO DEL CONTACTO A LAS CUCHILLAS DE CORTADORA





	No ponga los dedos debajo de la cortadora
	No ponga las manos debajo de la cortadora trituradora
	No ponga el pie debajo de la cortadora
	No ponga el pie debajo de la cortadora trituradora
	Riesgo de cizallamiento por las cuchillas de hoz
	Detenga el tractor. Quite la llave. Lea el Manual

**▲ PELIGRO** MANTÉNGASE LEJOS DE LAS CUCHILLAS GIRATORIAS PARA EVITAR LESIONES GRAVES O LA MUERTE POR CONTACTO CON LA CUCHILLA:

- **MANTÉNGASE LEJOS Y NO ACERQUE LAS MANOS, LOS PIES Y EL CUERPO** a las cuchillas giratorias, líneas de conducción y partes hasta que todos los elementos móviles se hayan detenido.
- **NO ponga las manos o los pies debajo de las plataformas de la cortadora**
- **DETENGA las CUCHILLAS giratorias, desconecte el interruptor de la cortadora y la TDF (PTO)** y espere que la cuchilla deje de girar antes de levantar el cabezal de la cortadora.
- **NO** se acerque el cabezal de la cortadora de hoz hasta que el motor del tractor haya sido apagado.
- **DETENGA la cortadora, EXAMINELA Y PRESTE ATENCIÓN A LOS SONIDOS** antes de acercarse a la cortadora para asegurarse de que se haya detenido todo el movimiento giratorio. *PN MBBM-01 SP*

# SEGURIDAD

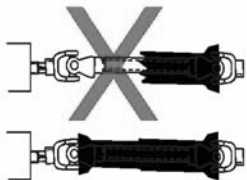
## RIESGO DE ENREDO POR EL PTO

<p>Peligro de enredo No se acerque o toque ningún eje de transmisión de PTO giratorio</p>	
<p>Asegúrese de que el eje de PTO esté firmemente sujetado. No use un adaptador de PTO</p>	
<p>No opere la máquina si las cubiertas de PTO están dañadas o faltantes</p>	
<p>Asegúrese de que los ejes de PTO sean del largo adecuado</p>	

**PELIGRO** MANTÉNGASE ALEJADO DE LAS LÍNEAS DE CONDUCCIÓN Y OTROS ELEMENTOS GIRATORIOS PARA EVITAR LESIONES GRAVES O LA MUERTE:

MANTÉNGASE LEJOS Y NO ACERQUE las manos, los pies y el cuerpo a las cuchillas giratorias, líneas de conducción y partes hasta que todos los elementos móviles se hayan detenido.

- **DETENGA la cortadora, EXAMÍNELA Y PRESTE ATENCIÓN A LOS SONIDOS** antes de acercarse a la cortadora para asegurarse de que se haya detenido todo el movimiento giratorio.
- **LOS ELEMENTOS GIRATORIOS SIGUEN ROTANDO una vez apagada la PTO.**

### PROTECCIÓN DE LA PTO:

PARA EVITAR LESIONES GRAVES O LA MUERTE POR ENREDO AL OPERAR EL IMPLEMENTO:

- **MANTENGA** instalados los protectores, las cubiertas integrales de las líneas de conducción y las cubiertas de entrada
- **NO OPERE** la cortadora si los protectores o cubiertas no están bien colocados o faltan.
- **REEMPLACE O REPARÉLOS** si faltan, están dañados o rotos
- **SIEMPRE REEMPLACE LOS PROTECTORES** que se han quitado para tareas de reparación o mantenimiento.

PARA EVITAR que la línea de conducción se rompa durante las operaciones:

- **VERIFIQUE** que la línea de conducción tenga el largo adecuado entre el eje de **PTO** y el eje de la caja de cambios del implemento.
- Las líneas de conducción demasiado cortas se pueden soltar o romper.
- Las líneas de conducción demasiado largas pueden tocar el suelo.
- Un ensamblaje telescópico de la línea de conducción que toque el suelo no se deslizará y se solidificará.
- Si la línea de conducción toca el suelo, puede atravesar los cojinetes de soporte y romper el eje de **PTO**.
- **EVITE** hacer curvas pronunciadas o elevar la cortadora a alturas que puedan hacer caer la línea de conducción.
- Lubrique los componentes telescópicos del eje de transmisión en forma semanal.

**COMUNIQUESE CON EL DISTRIBUIDOR** si la línea de conducción del implemento no coincide con el eje de **PTO** del tractor:

- **NO UTILICE UN ADAPTADOR DE PTO.**

El uso de un adaptador de **PTO** puede causar vibración excesiva, caída de objetos, fallas de las cuchillas y el implemento como consecuencia de la duplicación de la velocidad operativa. El aumento de la longitud de trabajo puede exponer áreas desprotegidas de la línea de conducción. *PN PE01 SP*

**SEGURIDAD**

**RIESGO DE ATROPELLO**

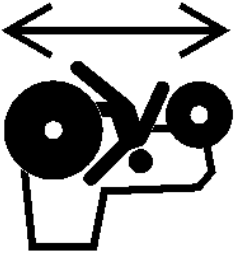
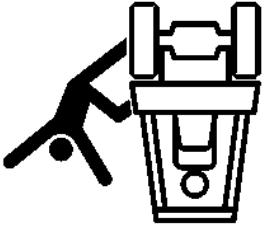
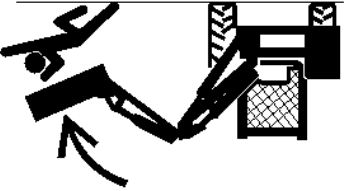
 <p>Riesgo de atropello del operador</p>	 <p>Riesgo de atropello por caída del operador</p>	 <p>Riesgo de atropello de personas presentes</p>
---	---	--

**▲ PELIGRO** PARA EVITAR LESIONES GRAVES O LA MUERTE POR CAÍDA DEL TRACTOR O ATROPELLO DEL EQUIPO:

- USE tractores equipados con SISTEMA ANTIVUELCO (ROPS) y CINTURONES DE SEGURIDAD para las operaciones de corte.



- MANTENGA EL SISTEMA ROPS trabado en posición vertical.
- SÓLO ENCIENDA el tractor sentado en el asiento del tractor.
- SIEMPRE ABRÓCHESE el cinturón de seguridad al operar el tractor y los equipos.
- SÓLO OPERE el tractor y el equipo sentado en el asiento del tractor.
- NUNCA LLEVE A OTRAS PERSONAS en el tractor o implemento.
- Cuando no esté cortando, coloque el brazo y el cabezal de la cortadora en el espacio de transporte antes de moverse.

**AL SUBIR Y BAJAR DEL TRACTOR:**

- SÓLO suba o baje del tractor cuando éste y sus partes móviles estén detenidos.
- APAGUE EL MOTOR Y LA TDF, coloque el freno de mano, descienda del implemento, espere a que se detengan todas las partes móviles y quite la llave antes de bajarse del tractor. *PN ROBM-01 SP*

# SEGURIDAD

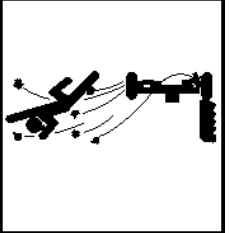
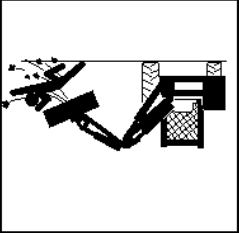
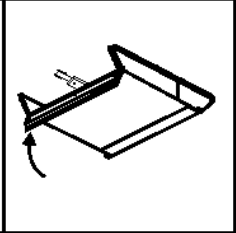
## RIESGO DE OBJETOS LANZADOS (Continuado)

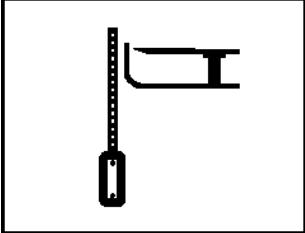

	<p>Peligro de objetos lanzados por la cortadora</p>	<p>Objetos lanzados desde la cortadora elevada</p> 	<p>Mantenga la puerta de la cortadora cerrada si el tráfico se encuentra al menos de 300 pies</p> 	<p>Inspeccione el área. Quite los objetos extraños</p> 	<p>No permita que las cuchillas entren en contacto con objetos sólidos</p> 
---	---	---	---	--	--

### OPERACIÓN DE LA CORTADORA:

- **NO** exceda la capacidad de corte nominal de la cortadora, ni corte elementos que no sean vegetación.
- **USE CABINAS DE TRACTOR CERRADAS** cuando haya dos o más cortadoras operando en un mismo sector.
- No opere la cortadora en áreas susceptibles al ataque de abejas o insectos, salvo que **USE PRENDAS PROTECTORAS** o una cabina de tractor cerrada.
- **AJUSTE LA ALTURA DE CORTE PARA EVITAR EL CONTACTO DE LAS CUCHILLAS** con objetos sólidos, como alambres, piedras, postes, cordones, guardarrailles y obstrucciones fijas.
- **CIERRE** la puerta de la cortadora y detenga la operación si se acercan transeúntes a 100 metros (300 pies) a la redonda de la cortadora.
- Mantenga la puerta de la cortadora cerrada cuando corte cerca del suelo.
- Abra la puerta sólo para cortar ramas grandes de arbustos o árboles. Cierre la puerta inmediatamente después de cortar la rama.
- **NO** empuje el cabezal de la cortadora hacia abajo sobre el material para cortarlo, use las puntas frontales de las cuchillas de la cortadora para cortar el material.
- **NO** opere la cortadora cuando la cortadora esté en posición de transporte.
- **DETENGA LA CORTADORA** de inmediato si las cuchillas entran en contacto con objetos pesados, estructuras fijas, guardarrailles de metal y estructuras de cemento.
- **1. LAS CUCHILLAS PUEDEN FALAR** con el impacto y los objetos pueden ser arrojados a gran velocidad.
- **2. INSPECCIONE Y REEMPLACE** las cuchillas dañadas.
- **3. VERIFIQUE** el equilibrio del porta cuchillas y **REEMPLÁCELO** si está dañado.
- **NO** opere la cortadora en agua **PARA EVITAR** una posible **FALLA DE LAS CUCHILLAS**.
- **EVITE OPERAR LA CORTADORA** en reversa:
  1. **DETENGA EL PTO** y retroceda la cortadora.
  2. **DESCIENDA** la cortadora, encienda el **PTO** y corte hacia adelante.
- **DESCONECTE** el cabezal de la cortadora y espere hasta que las **CUCHILLAS** dejen de rotar antes de levantar la cortadora a la posición de transporte.
  - **NO** encienda el **PTO** con la cortadora en posición de transporte.
  - **DETENGA** la cortadora cuando se produzca **VIBRACIÓN EXCESIVA**:
    1. **DETENGA EL PTO Y EL MOTOR** del tractor.
    2. **INSPECCIONE** la cortadora para detectar la fuente de la vibración
    3. **REEMPLACE** toda parte dañada o las **CUCHILLAS** dobladas o dañadas. *PN TOBM-02 SP*

# SEGURIDAD

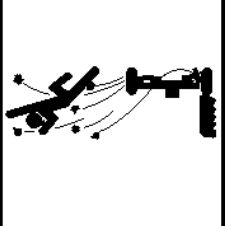
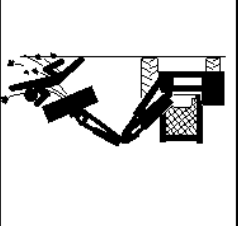
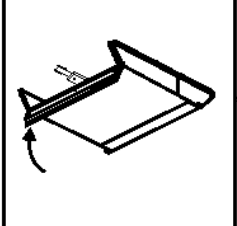
## RIESGO DE OBJETOS LANZADOS

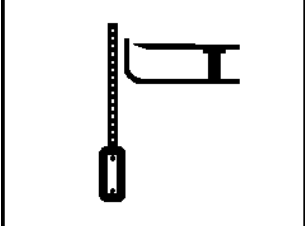
 <p>Peligro de objetos lanzados por la cortadora</p>	 <p>Objetos lanzados desde cortadora elevada</p>	 <p>Mantenga la puerta cerrada si el tráfico de la cortadora se encuentra al menos de 300 pies</p>	 <p>Inspeccione el área. Quite los objetos extraños</p>	 <p>No permita que las cuchillas entren en contacto con objetos sólidos</p>
---	--	---	--	--

**▲ PELIGRO** LAS CORTADORAS GIRATORIAS PUEDEN ARROJAR OBJETOS A 90 METROS (300 PIES) O MÁS EN CONDICIONES ADVERSAS.

PARA EVITAR LESIONES GRAVES O LA MUERTE AL OPERADOR O TRANSEÚNTES COMO CONSECUENCIA DE OBJETOS ARROJADOS:

- **MANTENGA** a los transeúntes a 100 metros de distancia (300 pies)
- **NO OPERE LA CORTADORA SI HAY PERSONAS A MENOS DE 100 METROS(300 PIES), SALVO QUE:**
  - Todos los **PROTECTORES CONTRA OBJETOS ARROJADOS** estén colocados y en buen funcionamiento al operar la cortadora, entre los que se incluyen los deflectores frontales y traseros, los protectores de cadena, los protectores de acero, las bandas, los faldones laterales y las zapatas antideslizantes.
  - El Cabezal de la cortadora esta ajusta cerca y paralela al suelo, sin exponer las cuchillas.
  - Se ha inspeccionado el **ÁREA DE CORTE** y se han quitado todos los materiales extraños y residuos.
  - **NO** corte material suelto o cortado previamente si hay **TRANSEÚNTES** dentro de 100 metros a la redonda. *Los TRANSEÚNTES estén en el interior de un vehículo cerrado.*
- **ANTES DE OPERAR LA CORTADORA, INSPECCIONE EL ÁREA PARA DETECTAR LA POSIBILIDAD DE OBJETOS QUE PUEDAN SER LANZADOS:**
  - **QUITE** residuos, piedras, cables, alambres, objetos metálicos y cualquier otro objetos extraños del área. Los alambres, cables, sogas, cadenas y objetos metálicos pueden ser arrojados o salir desprendidos de la plata-forma a gran velocidad:
  - 1. **MARQUE** los objetos que no se puedan quitar.
  - 2. **EVITE** estos objetos cuando use la cortadora.



- **INSPECCION DEL ÁREA PARA DETECTAR HIERBA ALTA Y MALEZAS:**
  - **INSPECCION Y quite** cualquier residuo oculto de gran tamaño.
  - **PASE LA CORTADORA** a una altura intermedia
  - **INSPECCION** y quite el residuo restante
  - **PASE LA CORTADORA** a la altura final
- **PROTECCIÓN CONTRA OBJETOS ARROJADOS DE LA CORTADORA:**
  - **MANTENGA** todos los protectores contra objetos arrojados en su lugar y en buen funcionamiento al operar la cortadora, entre los que incluyen los deflectores frontales y traseros, los protectores de cadena, los protectores de acero, las bandas, los faldones laterales y las zapatas antideslizantes.
  - **NO OPERE LA CORTADORA** si falta algún protector contra objetos arrojados, o si estos están dañados.

- Ninguna protección ofrece una eficacia del 100% en la prevención de objetos arrojados. Para reducir la posibilidad de que se produzcan lesiones:
- **DERECHO DE PASO (autopista) CON LA CORTADORA**
  - **MANTENGA** los protectores contra objetos arrojados en su lugar y en buen funcionamiento al operar la cortadora, entre los que incluyen los deflectores frontales y traseros, los protectores de cadena, los protectores de acero, las bandas, los faldones laterales y las zapatas antideslizantes.
  - **NO OPERE LA CORTADORA** si falta algún protector contra objetos arrojados, o si estos están dañados.
- **INSPECCION Y quite** cualquier residuo oculto de gran tamaño.
- **PASE LA CORTADORA** a una altura intermedia
- **INSPECCION** y quite el residuo restante
- **PASE LA CORTADORA** a la altura final

PA41 04/12 Sección de Seguridad 1-6

# SEGURIDAD

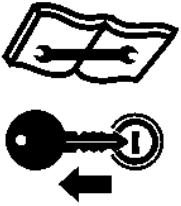
## CONECTAR O DESCONECTAR EL IMPLEMENTO DE SEGURIDAD

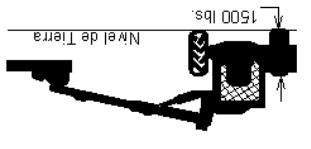
 <p>Detenga el tractor Quite la llave Lea el Manual</p>	 <p>Riesgo de aplastamiento. NO se coloque debajo del brazo cuando conecte el cabezal de la cortadora al brazo</p>	 <p>Riesgo de estabilidad. Asegúrese de que el 20% del peso del tractor esté en las ruedas.</p>	 <p>Riesgo de estabilidad. Asegúrese de que haya una fuerza hacia abajo de 1500lb sobre la rueda izquierda con el brazo extendido.</p>
--	--	--	---

**▲ PELIGRO** PARA EVITAR LESIONES GRAVES O LA MUERTE POR APLASTAMIENTO POR EL TRACTOR O IMPLEMENTO:

**CUANDO conecte el cabezal de la cortadora al brazo:**

- MANTENGA A LOS TRANSEÚNTES LEJOS del tractor y la cortadora.
- Asegúrese de que haya espacio suficiente para elevar y mover el brazo sin golpear objetos

**ANTES de conectar y desconectar el cabezal de la cortadora o el brazo:**

- APAGUE EL MOTOR DEL TRACTOR, coloque la palanca en "estacionar", ponga el freno de mano y saque la llave.

**CUANDO conecte y desconecte el cabezal de la cortadora o el brazo:**

- NO se agache o camine debajo del cabezal o el brazo de la cortadora en posición elevada. (Consulte las instrucciones en la sección de Operación)

**AL CONECTAR LA LÍNEA DE CONDUCCIÓN DEL IMPLEMENTO: (Si está equipado)**

**PARA EVITAR que la línea de conducción del implemento se suelte durante la operación:**

- LUBRIQUE el anillo de cierre del resorte del yugo para asegurarse de que se deslice libremente sobre el eje de TDF
- ASEGURE las bolas de cierre del yugo en la muesca del eje de TDF.
- PRESIONE y JALE LA LÍNEA DE CONDUCCIÓN del EJE DE TOMA DE FUERZA del tractor y del implemento para asegurarse de que estén FIRMEMENTE SUJETADOS

**PARA EVITAR que la línea de conducción se rompa durante las operaciones:**

- VERIFIQUE que la línea de conducción tenga el largo adecuado entre el eje de PTO y el eje de la caja de cambios del implement (Consulte las instrucciones en la sección de Operación)
- Las líneas de conducción demastado cortas se pueden soltar o romper.
- Las líneas de conducción demastado largas pueden tocar el suelo.
- Un ensamble telescópico de la línea de conducción que toque el suelo no se deslizará y se solidificará.
- Si la línea de conducción toca el suelo, puede atravesar los cojinetes de soporte y romper el eje de TDF(PTO).



**COMUNIQUESE CON EL DISTRIBUIDOR si la línea de conducción del implemento no coincide con el eje de TDF(PTO) del tractor:**

**NO UTILICE UN ADAPTADOR DE TDF(PTO).**

- El uso de un adaptador de TDF(PTO) puede ocasionar:  
Vibración excesiva, caída de objetos, fallas de la cuchilla y el implemento como consecuencia de la duplicación de la velocidad operativa.
- Mayor extensión de trabajo, lo que deja expuestas áreas desprotegidas de la línea de conducción e implica el riesgo de entedo con otros objetos. PN CDBM-01

# SEGURIDAD

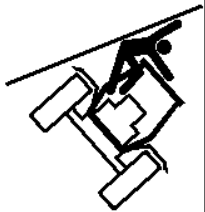
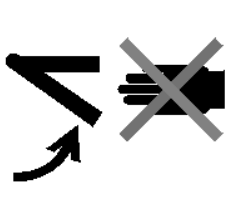
## RIESGO DE APLASTAMIENTO

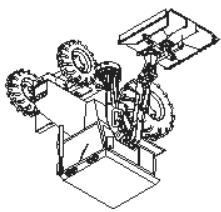
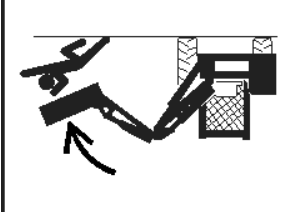
	Lesión por aplastamiento por la caída del brazo o el cabezal de la cortadora
	Riesgo de punto de compresión. Mantenga las manos y el cuerpo lejos de los puntos de compresión
	Siempre utilice cinturón de seguridad
	Use un tractor con cabina con las cortadoras con brazo
	Lesión por aplastamiento causada por la caída del brazo o el cabezal de la cortadora

**PELIGRO** PARA EVITAR LESIONES GRAVES O LA MUERTE POR CAÍDA DEL TRACTOR O ATROPELLO DEL EQUIPO, VUELCO O APLASTAMIENTO POR LA CAÍDA DEL BRAZO O EL IMPLEMENTO:

- USE tractores equipados con SISTEMA ANTIVUELCO (ROPS) y CINTURONES DE SEGURIDAD para las operaciones de corte.
- MANTENGA EL SISTEMA ROPS trabado en posición vertical.
- SIEMPRE ABROCHESE el cinturón de seguridad al operar el tractor y los equipos.
- SOLO OPERE el tractor y el equipo sentado en el asiento del tractor.

### AL ELEVAR EL BRAZO DE LA CORTADORA:

- Eleve o descienda SOLO CUANDO ESTÉ SENTADO en el asiento del tractor, y con el cinturón de seguridad ajustado.
- MANTENGA A LOS TRANSEUNTES FUERA del área de operación PARA EVITAR accidentes por aplastamiento.
- MANTENGA suficiente espacio libre alrededor de los implementos PARA EVITAR el contacto con edificios o cables elevados.
- LIFTED Equipment can fall from mechanical or hydraulic failure or inadvertent Control Lever movement.

**ADVERTENCIA** PARA EVITAR LA CAÍDA DEL EQUIPO al trabajar cerca o debajo del brazo elevado, los componentes y el cabezal de la cortadora:

- SUJETE CON FIRMEZA o bloquee en posición vertical todos los equipos, aletas y componentes elevados.
- BLOQUEE EN POSICIÓN VERTICAL y sujete con firmeza el equipo antes de poner las manos, los pies o el cuerpo debajo de los equipos o componentes elevados.
- MANTENGA A LOS TRANSEUNTES LEJOS del brazo elevado o el cabezal de la cortadora hasta que estén bloqueados de forma segura.

### AL ESTACIONAR el implemento y el tractor:

- DESCienda el cabezal de la cortadora hasta el suelo o BLOQUEE las partes elevadas antes de alejarse del equipo.
- NUNCA deje un implemento sin atención en posición elevada.





**ADVERTENCIA** PARA EVITAR LA CAÍDA O EL APLASTAMIENTO DE NIÑOS POR EL EQUIPO:

- NUNCA DEJE que los niños jueguen sobre el tractor o los implementos, ni en sus alrededores.
- NO OPERE el equipo sin CABINA CERRADA o PROTECCIÓN SUPERIOR. Las ramas y los residuos que caen pueden causar lesiones. PN CHBM-01

# SEGURIDAD

# SEGURIDAD

## SEGURIDAD DEL OPERADOR

	Lea con atención el Manual del Operador
	Siempre use gafas de seguridad
	Use casco y calzado protector
	Nunca consuma drogas o alcohol mientras opera el equipo
	Utilice chaleco de seguridad al operar en o cercas de carreteras

PARA EVITAR LESIONES GRAVES O LA MUERTE, SIGA LAS SIGUIENTES INSTRUCCIONES:



- LEA, COMPRENDA Y SIGA las instrucciones del Manual del Operador, al igual que las Advertencias y Mensajes de Seguridad.
- USE GAFAS DE SEGURIDAD, calzado protector, casco, protección auditiva y guantes al operar o reparar el equipo
- USE un aparato de respiración apropiado al operar en condiciones polvorientas a fin de evitar contraer enfermedades respiratorias.
- NO USE prendas sueltas o joyas que se puedan enredar con las partes giratorias y causar una lesión.
- NO CONSUMA DROGAS o ALCOHOL antes o durante la operación del equipo.
- NO PERMITA que nadie opere el equipo bajo los efectos negativos de las drogas o el alcohol.
- CONSULTE a un médico para conocer los efectos desfavorables de la medicación sobre los sentidos
- EVITE EL CONTACTO con superficies calientes tales como silenciadores, bombas hidráulicas, válvulas y tanques.
- MANTÉNGASE ALERTA, la operación prolongada puede causar fatiga. HAGA UNA PAUSA y DESCANSE.

### SEGURIDAD DE OPERACIÓN GENERAL

- **CONDICIONES DE VISIBILIDAD AL USAR LA CORTADORA:**
- **OPERE LA CORTADORA CON LUZ SOLAR** o con luz que aporte una visibilidad nítida de más de 90 metros (100 yardas).
- **DEBE PODER VISUALIZAR** e identificar transeúntes, terrenos empinados, pozos, desniveles, obstrucciones elevadas, cables de alimentación, residuos y objetos extraños.
- Evite retroceder mientras opera la cortadora: la visión es limitada y pueden ocurrir daños o lesiones severas.
- NO OPERE el tractor en un recinto cerrado sin ventilación adecuada de los gases de escape.

### VELOCIDAD RESPECTO AL SUELO AL USAR LA CORTADORA:

- El rango de VELOCIDAD NORMAL es de entre 1 y 2 millas por hora (1-3kph).
- AJUSTE LA VELOCIDAD DE CORTA según las condiciones del terreno y el tipo de césped, la densidad y la altura del corte.
- REDUZCA LA VELOCIDAD DE CORTA al acercarse a inclinaciones empinadas, pozos, desniveles, obstrucciones elevadas, cables de alimentación y para evitar residuos y objetos extraños.

### TRACTOR Y CORTADORA

- NO OPERE el tractor o la cortadora a menos que hayan recibido el mantenimiento adecuado y funcionen correctamente
- DETENGA LA OPERACIÓN si los controles eléctricos o hidráulicos del tractor o la cortadora no funcionan correctamente.
- DETENGA LA OPERACIÓN del tractor si los sistemas de frenado o dirección no funcionan correctamente.
- NO OPERE el tractor o la cortadora si hay pérdidas de líquido hidráulico.

### INFESTACIÓN CON INSECTOS

- No opere en áreas susceptibles al ataque de abejas o insectos, salvo que USE PRENDAS PROTECTORAS o una cabina de tractor cerrada.

### VELOCIDAD DE CUCHILLAS DE LA CORTADORA:

- NO EXCEDA LA VELOCIDAD NOMINALES DE RPM DEL IMPLEMENTO.
- EVITE superar las velocidades nominales de RPM de la cabaza cortadora, porque puede resultar sobrecalentamiento o fallas en el componente y las cuchillas.

### SEÑALES DE SEGURIDAD:

- REEMPLACE cualquier señal de seguridad faltante, dañada o ilegible PN OSBM-01 SP



## INSTRUCCIONES DE SEGURIDAD Y PRÁCTICAS GENERALES

El mejor operador es un operador cuidadoso. La seguridad es de importancia fundamental para el fabricante, y también debería serlo para el propietario u operador. La mayoría de los accidentes se pueden evitar prestando suma atención al equipo, al ambiente circundante, y tomando algunas precauciones. La primera sección de este manual incluye una lista de Mensajes de Seguridad que deben observarse para contribuir a la protección del operador y otras personas frente a lesiones o la muerte. Lea con atención estos Mensajes de Seguridad antes de ensamblar, operar o reparar este implemento. Este equipo sólo debe ser operado por personas que hayan leído el manual, responsables y calificadas, que sepan cómo hacerlo de manera responsable.

El Símbolo de Alerta de Seguridad se utiliza en combinación con una Señal Verbal, tal como la que se muestra a continuación, en todo este manual y en los autoadhesivos adheridos a los equipos. El Símbolo de Alerta de Seguridad significa:



“¡ATENCIÓN! MANTÉNGASE ALERTA! SU SEGURIDAD ESTÁ EN JUEGO!” El Símbolo y la Señal Verbal tienen el objetivo de advertir al propietario/operador sobre un riesgo inminente y el grado de lesión que se puede producir al operar este equipo.

**Adopte todas las medidas habituales para trabajar en forma segura y, sobre todo, recuerde que la seguridad depende de USTED. Sólo USTED puede impedir una lesión grave o la muerte a causa de prácticas no seguras.**

Indica una situación peligrosa inminente que, de no ser evitada, **OCASIONARÁ** la **MUERTE O UNA LESIÓN MUY GRAVE**.



Indica una situación peligrosa inminente que, de no ser evitada, **PODRÍA OCASIONAR** la **MUERTE O UNA LESIÓN MUY GRAVE**.



Indica una situación peligrosa inminente que, de no ser evitada, **PODRÍA OCASIONAR** **UNA LESIÓN MENOR**.



Identifica instrucciones o procedimientos específicos que, de no observarse estrictamente, podrían ocasionar daños o la destrucción de la maquinaria, los accesorios o el entorno.



**NOTA:** Identifica aspectos de particular interés para lograr una operación o reparación más eficiente y conveniente.



**LEA CON ATENCIÓN Y RESPETE** los siguientes Mensajes de Seguridad. Si no se siguen cuidadosamente las advertencias e instrucciones indicadas en este Manual y en los Mensajes de Seguridad del implemento, se pueden producir lesiones graves o la muerte. Siempre siga las instrucciones de este manual y use el sentido común para evitar situaciones peligrosas.

**NOTA:** Si desea obtener una traducción de esta sección de seguridad en alguno de los siguientes idiomas, comuníquese con: *Translations, a la dirección 1502 E. Walnut Street Seguin, TX 78155; Fax: (830) 372-9529; La Sección de Seguridad está disponible en español, portugués, francés, alemán, ruso. PN 6501 SP*

# SECCIÓN DE SEGURIDAD

Sección de Seguridad 1-1



## Instrucciones de operaciones antes de la entrega del DISTRIBUIDOR al CLIENTE

El distribuidor deberá informar al comprador de este producto las condiciones, disposiciones y procedimientos de garantía aplicables; informar la responsabilidad del comprador de capacitar a sus operadores para la operación segura; revisar el contenido del Manual del Operador, incluido el equipo de seguridad, la operación segura y el mantenimiento; y revisar las Señales de Seguridad que se encuentran en el implemento (y en el tractor, de ser posible).

- **IMPLEMENTOS:** He explicado que los defletores, protectores de cadena o faldones sólidos se deben mantener en buenas condiciones de reparación y se deben instalar, excepto en zonas donde personas, vehículos, ganado u otros bienes no corran peligro por objetos arrojados, y en los casos en que dichos equipos de seguridad impedirían un desempeño razonable de la cortadora en su tarea asignada.
- **LÍNEAS DE CONDUCCIÓN:** Me he asegurado de que todos los protectores de líneas de conducción, de caja de engranajes y otros están en buenas condiciones de reparación y firmemente sujetados para prevenir lesiones por enredo u objetos arrojados.

- **MÁQUINAS HIDRÁULICAS:** He explicado la necesidad de usar aceite hidráulico limpio, cambiar los filtros según las instrucciones, detener filtraciones, prevenir daños por operar con aceite demasado caliente, cuidar las mangueras, usar mangueras del tipo correcto, mantener la presión operativa especificada y prevenir el posible riesgo de que el aceite penetre en la piel.
- **IMPLEMENTOS PLEGABLES:** He explicado que no es posible proteger contra objetos arrojados cuando el cabezal está elevado del suelo y que el operador es responsable de verificar que no existan personas en las inmediaciones. He explicado que el brazo o cabezal de cortadora elevado puede entrar en contacto con obstrucciones elevadas y dañar cables y líneas telefónicas, y posiblemente causar lesiones. He explicado que el brazo o cabezal extendido, o el brazo retraído, puede entrar en contacto con cables de alimentación y causar lesiones o la muerte por electrocución, y que el operador es responsable de evitar dichos riesgos.

## SERVICIO ANTES DE LA ENTREGA VERIFIQUE Y AJUSTE O LUBRIQUE SEGÚN SEA NECESARIO

Consulte los detalles en el Manual del Operador  
Inspección realizada – Garantía y procedimientos de seguridad explicados – Instalación realizada

<b>LUBRICACIÓN E HIDRÁULICA</b>	
<input type="checkbox"/>	Caja de engranajes (niveles de aceite)
<input type="checkbox"/>	Nivel de aceite hidráulico (tanque externo)
<input type="checkbox"/>	Nivel de aceite hidráulico del tractor
<input type="checkbox"/>	Mangueras hidráulicas (no retorcidas y ajustadas)
<input type="checkbox"/>	Propulsor de bomba frontal (conjunto ajustado y eje bien alineado)
<b>CORTADORA</b>	
<input type="checkbox"/>	Fernos de husillo y motor bien ajustados
<input type="checkbox"/>	Nivel de aceite del husillo
<input type="checkbox"/>	Fernos de porta cuchillas bien ajustados/pasadores de retención colocados
<input type="checkbox"/>	Nivel y altura de corte de la cortadora ajustados
<input type="checkbox"/>	Cojinetes del eje de corte lubricados
<input type="checkbox"/>	Todas las piezas metálicas bien ajustadas
<input type="checkbox"/>	Presión de aire y neumáticos/tuercas de rueda (bien ajustadas)
<input type="checkbox"/>	Cojinetes de rueda (verificar, engrasar y hacer carga previa)
<b>ACCESORIOS E INSTALACIÓN</b>	
<input type="checkbox"/>	Defletores frontales y traseros
<input type="checkbox"/>	Accesorios de trituración
<input type="checkbox"/>	Sentido de giro de las hojas correcto
<input type="checkbox"/>	Vigas y brazos de eje
<input type="checkbox"/>	Lengüeta y barras de control (instaladas y ajustadas)
<input type="checkbox"/>	Todos los pernos, pasadores y tuercas (ajuste correcto)
<b>CONEXIONES DE CORTADORA A TRACTOR</b>	
<input type="checkbox"/>	Longitud de barra de enganche (verificar y fijar)
<input type="checkbox"/>	Pivote y conexiones de bastidor en A
<input type="checkbox"/>	Barras de control (ajustadas iguales)
<input type="checkbox"/>	Altura de eje (ajustar)
<input type="checkbox"/>	Altura de corte (ajustar)
<input type="checkbox"/>	Verificación de pre-operación de kit de montaje
<input type="checkbox"/>	Ala de cortadora (ajustar nivel con el centro)
<input type="checkbox"/>	Ala de cortadora (verificar operación de elevación correcta)
<input type="checkbox"/>	Líneas de conducción C.V. (verificar radio de giro máx.)
<input type="checkbox"/>	Enganche de tracción (ajuste de altura)
<input type="checkbox"/>	Piezas metálicas de montaje bien ajustadas
<b>ELEMENTOS DE SEGURIDAD</b>	
<input type="checkbox"/>	Protectores (operación e instalación)
<input type="checkbox"/>	Embrague de línea de conducción (limitador de ajuste)
<input type="checkbox"/>	(ajustar y poner en marcha)
<input type="checkbox"/>	Autoadhesivos de seguridad (colocados)
<input type="checkbox"/>	Manual del Operador (entregado)
<input type="checkbox"/>	Protector de TDF del tractor (instalado)
<input type="checkbox"/>	Emblema S.M.V. (instalado de ser necesario)
<input type="checkbox"/>	Gato con lengüeta (instalación y operación)
<input type="checkbox"/>	Cadena de remoique de seguridad (instalada)
<input type="checkbox"/>	Manual de Seguridad de Línea de Conducción ADMA (entregado)
<input type="checkbox"/>	Manual de Seguridad de Cortadora AEM (entregado en porta manual)
<input type="checkbox"/>	Se mostró el Video de Seguridad de Cortadora AEM al comprador

**Alamo Industrial está dispuesto a suministrar un (1) Video de Prácticas de Seguridad para Cortadoras AEM**

Por favor enviar:  Video de Seguridad para el Operador de Cortadoras AEM/FEMA – formato VHS

Video de Seguridad para el Operador de Cortadoras AEM/FEMA – formato DVD

Manual del Operador de la Cortadora

Manual de Seguridad del Operador de la Cortadora AEM

Nombre del solicitante: \_\_\_\_\_ Teléfono: \_\_\_\_\_

Dirección del solicitante: \_\_\_\_\_

Ciudad: \_\_\_\_\_

Estado: \_\_\_\_\_

Código postal: \_\_\_\_\_

Modelo de cortadora: \_\_\_\_\_ Número de serie: \_\_\_\_\_

Fecha de compra: \_\_\_\_\_ Vendedor del distribuidor: \_\_\_\_\_

Nombre del distribuidor: \_\_\_\_\_ Dirección del distribuidor: \_\_\_\_\_

Enviar por correo a:

AEM Video Services

1502 E. Walnut Street

Seguin, TX 78155

○ enviar por fax a:

(830) 372-9529

○ enviar por correo electrónico a:

AEMVideo@alamo-group.com

Video de cortadora AEM

# Entrenamiento de Seguridad *Hace la Diferencia*

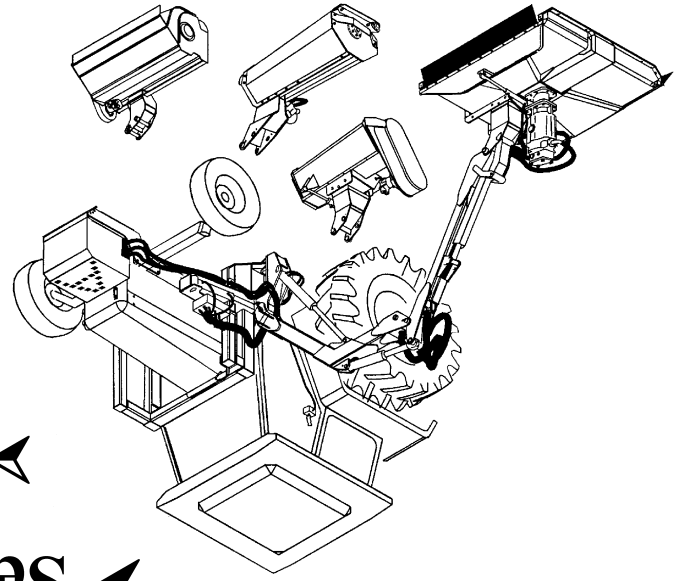

- **Sea Seguro**
  - **Sea Alerto**
  - **Sea Vivo**
  - **Sea Entrenado**
- antes de funcionar el cortacésped**

A fin de reducir la tasa de accidentes y mejorar la operación segura de las cortadoras, Alamo Industrial se ha asociado con otros fabricantes de la industria para desarrollar el video y la guía de Prácticas de Seguridad para Cortadoras Industriales y Agrícolas AEM/FEMA.

El video explica a los operadores de tractores y cortadoras las prácticas seguras que deben adoptar cuando utilizan cortadoras industriales y agrícolas. Es importante que todos los operadores de cortadoras aprendan cómo operar sus equipos de corte y puedan reconocer los posibles peligros que pueden surgir al operar una cortadora. Este video, en conjunto con el manual del operador de la cortadora y los mensajes de advertencia que se encuentran en la cortadora, serán muy útiles para complementar este aprendizaje tan importante.

Es posible que su distribuidor autorizado de Alamo Industrial le haya mostrado este video y le haya entregado una copia en DVD cuando adquirió su cortadora. Si usted o algún operador de cortadora no vio el video: mire el video, lea este Manual del Operador, y complete la Guía del Video antes de operar su cortadora nueva. Si no comprende alguna de las instrucciones del video o del manual del operador, o si tiene alguna pregunta acerca de la operación segura, comuníquese con su supervisor, con el distribuidor o con Alamo Group Ag.

Si desea recibir una copia del video en VHS, envíe un mensaje de correo electrónico a AEMVideo@alamo-group.com o un fax al (830) 372-9529, o envíe por correo una copia rellena del formulario que se encuentra al dorso de esta página a AEM VHS Video 1502 E Walnut Street, Seguin, TX 78155, y solicite la versión en VHS. Indique su nombre, dirección postal, modelo de cortadora y número de serie.

Cada uno de los operadores debe recibir capacitación para cada equipo (tractor y cortadora), comprender el uso previsto, y comprender los posibles peligros antes de operar el equipo.

La información y material mencionado en la información anterior junto con el Manual de Operador puede asistir en cumplir con los requisitos de OSHA para el entrenamiento anual del Operador.

## REQUISITOS DE ENTRENAMIENTO DEL OSHA

Los siguientes requisitos de entrenamiento se an toma del Título 29, código de la pieza de regulaciones federales 1928.57 (a) (6). [www.osha.gov](http://www.osha.gov)

instrucciones del operador. A la hora de la asignación inicial y por lo menos anualmente después de eso, el empleador mandará a cada empleado quien opera un tractor agrícola o implemento en las practicas de operación segura y el mantenimiento de el equipo con el cual el empleado este, o estará implicado y de cualquier otras prácticas dictados por el ambiente laboral.

## Al propietario/operador/distribuidor

Este Manual del Operador es una parte esencial de la operación segura de esta máquina y se debe mantener con la unidad siempre. El implemento incluye un porta manual donde se puede guardar el manual de manera adecuada. Si el manual se extravía o se daña, puede solicitar otra copia sin cargo a un distribuidor autorizado de Alamo Industrial o descargarlo del sitio web de Alamo Industrial ([www.alamo-industrial.com](http://www.alamo-industrial.com)).

ANTES DE COMENZAR LEA, COMPARENDA Y SIGA la información incluida en este manual, el Manual de Seguridad de la Cortadora AEM y el manual del operador del tractor para conocer cómo operar la máquina y realizar tareas de servicio correctamente. De lo contrario, podría sufrir lesiones u ocasionar lesiones a terceros. Todos los implementos con partes móviles son potencialmente peligrosos. Cada esfuerzo ha sido hecho para asegurar que la máquina esté segura, pero los operadores deben evitar entrar en prácticas peligrosas y seguir las instrucciones escritas que son proporcionadas. El fabricante ha diseñado este implemento para ser usado con todos sus equipos de seguridad sujetados para minimizar la probabilidad de accidentes.

LA SEGURIDAD PRIMERO. Lea con atención la totalidad de la sección de seguridad de este manual antes de operar el equipo. No permita que nadie opere el equipo sin haber leído y comprendido la totalidad de este manual. Comuníquese con el distribuidor si necesita explicación sobre alguna instrucción que no haya comprendido del todo.

Los cuidados que brinde a su implemento Alamo Industrial determinarán en gran medida su satisfacción con el desempeño y la vida útil del equipo. Lea con atención y siga las instrucciones de este manual para comprender cabalmente su nuevo implemento, su uso previsto, y sus requisitos de servicio.

Todas las referencias que se hacen en este manual a derecha, izquierda, frontal, trasero, arriba y abajo corresponden a la perspectiva en el sentido del desplazamiento hacia adelante con el implemento correctamente sujetado al tractor.

La información sobre repuestos se encuentra por separado en el Manual de Partes. Las cortadoras Alamo Industrial utilizan componentes del sistema equilibrados y coincidentes para porta cuchillas, cuchillas, ejes de corte, hojas, ganchos para hojas, rodillos, componentes de los engranajes, y cojinetes. Estas partes se fabrican y se prueban según las especificaciones de Alamo Industrial. Las partes compatibles no genúinas no siempre cumplen con estas especificaciones. El uso de partes no genúinas puede perjudicar el desempeño de la cortadora, anular la garantía y presentar un riesgo para la seguridad. Use partes genúinas Alamo Industrial para ahorrar dinero y maximizar la seguridad.

Para referencia futura, registre el número de modelo y el número de serie de Alamo Industrial que ha adquirido.

Owner	Fecha de compra:	Serial Number	
Distribuidor	Teléfono	Fecha de compra:	



# PA41

CORTADORA CON BRAZO HIDRÁULICO



Publicado en 04/12

Parte n°. 41486.50

## MANUAL DE OPERADOR

Este Manual del Operador es una parte esencial de la operación segura de esta máquina y se debe mantener con la unidad siempre. LEA, ENTIENDA, y SIGA las instrucciones de Seguridad y Operación contenidas en este manual antes de operar el equipo. C01-Cover

SP

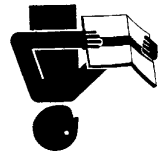

**ALAMO INDUSTRIAL®**

1502 E. Walnut  
Seguin, TX 78155  
830-372-3551

Email: [parts@alamo-industrial.com](mailto:parts@alamo-industrial.com)

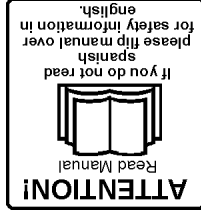

\$0.00

©2012 Alamo Group Inc.